

11.6	<b>PARKS, OPEN SPACES AND ENVIRONMENT: (PC: XL MDEMKA (MS))</b>
11.6.1	<b>INVESTIGATION WITH REGARDS TO THE VARIOUS RESIDENTIAL PROPERTIES IN MONT ROCHELLE NATURE RESERVE</b>

Collaborator No: 697006  
 IDP KPA Ref No: Good Governance and Compliance  
 Meeting Date: 17 November 2020

**1. SUBJECT: INVESTIGATION WITH REGARDS TO THE VARIOUS RESIDENTIAL PROPERTIES IN MONT ROCHELLE NATURE RESERVE**

**2. PURPOSE**

To put forward a recommendation as to the conclusion of the investigation with regards to the various residential properties in Mont Rochelle Nature Reserve.

**3. DELEGATED AUTHORITY**

Council of Stellenbosch Municipality.

**4. EXECUTIVE SUMMARY**

Council decided to investigate all possible options in dealing with the residential properties located in the Mont Rochelle Nature Reserve (the reserve) in an effort to achieve the most effective environmental outcome, address potential negative impact associated with possible development of the various properties whilst at the same time maintaining and preserving the use of the reserve for recreation by the broader public.

The above options investigated included maintaining the *status quo* (trust that no further development within the reserve take place), expropriation or buying-back of the 14 sold (but undeveloped) erven or an exchange of land (swop of erven within the reserve from sensitive to less-sensitive locations). Experience gained from the above investigation has now led to a proposed redesign of the current layout of erven clustered around the current access roads, within the existing layout footprint.

**5. RECOMMENDATIONS**

- (a) that Council approves Option 3: the redesign of the existing layout of erven in Mont Rochelle Nature Reserve;
- (b) that Option 3 be implemented once budget for this purpose becomes available;
- (c) that existing landowners of erven in sensitive area be offered a like-for-like (with reference to erf size) proposal in a less sensitive location within the revised layout, as provided for in Paragraph 9.2.3 of the Property Management Policy;
- (d) that the Municipal Manager be authorised to finalise the above process insofar an agreement between the relevant landowners can be reached; and
- (e) that the remaining unsold erven be de-proclaimed and consolidated into Mont Rochelle Nature Reserve.

---

## 6. DISCUSSION / CONTENTS

### 6.1 Background

62 Erven were proclaimed in Mont Rochelle Nature Reserve in 1910, 16 of which have been sold on auction to private individuals. The purpose of the auction was to generate funds for improving the Franschhoek sports facilities and water provision infrastructure to the town. Informal access roads to the erven were constructed by the municipality. During 1997 the (then) Franschhoek Council decided not to sell any of the remaining erven due to the possible negative environmental impact posed by the development of the erven and the lack of services to the properties. Houses have been built on 2 of the sold erven, with the remainder (14) lying vacant. None of the remaining 46 erven were, however, de-proclaimed and remain the property of Stellenbosch Municipality. The rights of the owners to develop their properties are still in place. There are no limiting conditions that prevent the owners from constructing any residential buildings.

Council has since made the decision to ensure that the potential negative environmental impact posed by the development of the erven be limited by investigating the possibilities available to it in this regard.

In January 2014 Council requested the appointment of an environmental specialist to investigate the various options available, from an environmental management perspective, but also taking into account legal rights of the current owners and, to advise Council on a way forward. During June 2015 service providers were invited to submit quotes to conduct an investigation in the above regard. Bids received ranged between R934 321.20 and R2 652 196.00. Given the high cost of the above investigation Council reconsidered its January 2014 resolution and decided that the funds rather be spent on consolidating the 46 un-sold erven with Mont Rochelle Nature Reserve and negotiations be entered into with the owners of the 14 sold (but undeveloped) erven regarding the possibility to exchange current erven within the reserve with erven in a more suitable area. Most owners of residential property within the reserve expressed their willingness to enter into negotiations for a possible land exchange. All the erven were surveyed and marked on-site and the various owners approached with proposals based on a "like-for-like" (erf size) basis. Owners responded with demands such as redesign of the current lay-out of erven, provision of access roads, provision of services, reimbursement of expenses on current property and the deregistration of bordering erven. In the light of the above it became clear that an erf-for-erf land exchange within the current layout of erven will likely not succeed. Council therefore is left with three options explained below.

### 6.2 Discussion

Based on the background described above, the options going forward can be summarized as follows:

Option 1: Maintaining status quo, in essence to wait and see, hoping that no further development within Mont Rochelle Nature Reserve take place. Although limited, seeing as only 2 properties have been developed since the establishment of the erven all those years back, there is a possibility of the existing or future owners developing their erven. Moreover, current technology makes "off-grid" living viable and property owners could feasibly build houses and supply their own services. The possible financial implications are limited to the receipt of some rates and taxes revenue.

Option 2: Agreeing with owner's demands within the current layout. This option will result in a dispersed layout and the construction of access roads at a considerable cost to Council.

Option 3: Redesign of the current layout, clustered around the current access roads, within the existing layout footprint. The possible financial implications will be the registration of the revised layout with the Surveyor General.

Of the above options, Option 3 is argued to be most preferred, based on the following advantages thereof:

- a) Clustering the layout together and minimizing the layout footprint;
- b) Utilising existing access roads and minimising the requirement of the construction of new roads (it is proposed that no services to private erven, other than access roads, will be provided by Council);
- c) Making better use of the site's topographical characteristics; and
- d) Providing a positive product in exchange for the current erven and thereby increasing the possibility of a successful land exchange and conclusion of the above Council Resolution.

This option would be in line with the below Council Resolution (October 2015) with specific reference to point (iii) *that any other feasible alternative that can limit the impact on the nature reserve that might be identified in the process be considered*, it is proposed that the existing private owners be presented with the option of a proposed layout redesign within the existing layout footprint.

### 6.3 Financial Implications

The financial implication depends on the option Council decides upon going forward. Option 1 (as described in Section 6.2 above) will have little financial implication at this stage but presents the highest risk in terms of avoiding the potential negative environmental impact posed by the development of the erven which Council is trying to avoid.

Of the three options Option 2 will have the largest financial implication with the provision of access to erven. It is proposed that no services to private erven, other than access roads, will be provided by Council. Option 2, however, will have limited impact in avoiding the potential negative environmental impact posed by the development of the erven other than moving private erven behind the ridgeline towards the visually less sensitive eastern slope of the site.

The financial implications of Option 3, if accepted and successfully negotiated with the owners of private erven within Mont Rochelle Nature Reserve, will be associated with de-registration of the existing - and registration of the new erven.

### 6.4 Legal Implications

#### 6.4.1 General

The rights of the owners to develop their properties are in place. There are no limiting conditions that prevent the owners from constructing any buildings. Council will have to consider building plans submitted from landowners, should any of the private land owners choose to submit the same.

#### 6.4.2 Property Management Policy

Paragraph 9.2.3 of the Municipality's policy on the management of Council-owned property provides for the exchange of land transactions under specific circumstances on condition that:

- 
- 9.2.3.1 *Disposal by exchange of land will be appropriate when it is advantageous to the Municipality and other parties to exchange land in their ownerships and will achieve best consideration for the municipality;*
- 9.2.3.2 *The Municipal Council must authorise the disposal of land by exchange with another land owner for alternative land. Reasons for justifying this manner of disposal must be recorded in writing; and*
- 9.2.3.3 *The exchange will usually be equal in value. However, an inequality in land value may be compensated for by other means where appropriate. In such circumstances the Municipality must seek an independent valuation to verify that "best consideration" will be obtained.*

## 6.5 Staff Implications

This report has no staff implications to the Municipality.

## 6.6 Previous / Relevant Council Resolutions:

### 17<sup>th</sup> Council Meeting: 2014-01-16: Item 7.2:

#### Resolved

- (a) that the Municipal Manager be requested to appoint an environmental specialist to investigate the various options, from an environmental management perspective, but also taking into account legal rights of the current owners and, to advise Council on a way forward, in general, but also regarding the specific properties facing the Franschhoek Valley;
- (b) that the views of the Advisory Board for the Mont Rochelle Nature Reserve and current land owners also be solicited during this investigation; and
- (c) that the Municipal Manager be requested to report on progress within 3 months.

### 35<sup>th</sup> Council Meeting: 28-10-2015: Item 7.6

#### Resolved

- (a) that Council reconsider its resolution of its meeting dated 2014-01-16, with regards to Item 7.2.
- (b) That the funds allocated to be spent on conducting the proposed investigation rather be spent on consolidating the 46 un-sold erven with Mont Rochelle Nature Reserve and negotiating with the owners of the 14 sold (but undeveloped) erven (the priority being erven 342, 307, 314, 322, 355, 336, located in a visually sensitive area north-eastern slope of "Du Toits Kop" facing the Franschhoek valley) regarding the possibility to exchange current erven within Mont Rochelle Nature Reserve with erven in a more suitable area (suitable in terms of environmental, visual and service delivery perspective).
- (c) That any other feasible alternative that can limit the impact on the nature reserve that might be identified in the process be considered.

## 6.7 Risk Implications

The risk to the Municipality is the potential that a development application, for the realisation of the development rights associated with the privately owned residential property in the reserve, is received with the municipality having no option but to consider an application that might ultimately have a detrimental impact on the surrounding environment.

**6.8 Comments from Senior Management**

This Item was circulated via e-mail to all internal Directorates on the 5<sup>th</sup> of October 2020 for comment by 14 October 2020. The Director: Infrastructure Services responded, requesting an amendment to the item (inclusion of the proposed redesign of the layout option in the executive summary) but indicated that he is, in general, satisfied with the content of the item.

**RECOMMENDATIONS FROM THE EXECUTIVE MAYOR, IN CONSULTATION WITH THE EXECUTIVE MAYORAL COMMITTEE, TO COUNCIL: 2020-11-17: ITEM 7.6.1**

- (a) that Council approves Option 3: the redesign of the existing layout of erven in Mont Rochelle Nature Reserve;
- (b) that Option 3 be implemented once budget for this purpose becomes available;
- (c) that existing landowners of erven in sensitive areas be offered a like-for-like (with reference to erf size) proposal in a less sensitive location within the revised layout, as provided for in Paragraph 9.2.3 of the Property Management Policy;
- (d) that the Municipal Manager be authorised to finalise the above process insofar as an agreement between the relevant landowners can be reached; and
- (e) that the remaining unsold erven be de-proclaimed and consolidated into Mont Rochelle Nature Reserve.

**FOR FURTHER DETAILS CONTACT:**

<b>NAME</b>	<b>Schalk van der Merwe</b>
<b>POSITION</b>	<b>Environmental Planner</b>
<b>DIRECTORATE</b>	<b>Community and Protection Services</b>
<b>CONTACT NUMBERS</b>	<b>021 808 8679</b>
<b>E-MAIL ADDRESS</b>	<b>schalk.vandermerwe@stellenbosch.gov.za</b>
<b>REPORT DATE</b>	<b>15 October 2020</b>

11.6.2	<b>PROGRESS REPORT (2) - IDENTIFICATION AND ACQUISITION OF AUTHORISATIONS AND APPROVALS FOR THE ESTABLISHMENT OF ONE OR MORE REGIONAL CEMETERIES FOR STELLENBOSCH MUNICIPALITY</b>
--------	--

Collaborator No: 697733  
 IDP KPA Ref No: Good Governance and Compliance  
 Meeting Date: 17 November 2020 and 25 November 2020

**1. SUBJECT: PROGRESS REPORT (2) - IDENTIFICATION AND ACQUISITION OF AUTHORISATIONS AND APPROVALS FOR THE ESTABLISHMENT OF ONE OR MORE REGIONAL CEMETERIES FOR STELLENBOSCH MUNICIPALITY**

**2. PURPOSE**

To report on the status of the above project. This is the second progress report following the one submitted to the February 2020 Section 80 Meeting.

**3. DELEGATED AUTHORITY**

Council of Stellenbosch Municipality.

**4. EXECUTIVE SUMMARY**

During 2016 Stellenbosch Municipality commenced with a project of identifying and acquiring the necessary environmental and land use approvals for the establishment of one or more large (±30ha) cemeteries for the WC024 area.

During a comprehensive feasibility study conducted 54 sites were considered against a set of criteria which included:

- Ownership (Municipal / State / Private)
- Extent
- Location (proximity to settlements / accessibility / surrounding land uses)
- Zoning and land use
- Environmental characteristics (current status / vegetation / geology / pedology / hydrology)
- Soil characteristics (excavability / permeability / drainage / topography / basal buffer / stability / workability)

A total of 4 sites were identified as being feasible:

- Louw's Bos (Farm 502, south of Stellenbosch)
- Culcatta Bos (Farm 29, north of Koelenhof)
- Meerlust (Portion 1 of Farm Meer Lust No 1006, Groot-Drakenstein)
- De Novo (Portion 10 of Farm De Novo No 727, south of Muldersvlei)

Of the 4 sites 2 were included in the process of acquiring the necessary environmental and land use approvals for the establishment of a cemetery. These 2 sites were Louw's Bos and Culcatta Bos. Even though the Meerlust site is ideally located (in terms of need for burial space) it was (for the time being) excluded due to risks associated with the site's location in close proximity to an existing settlement. The National Health Act, 61 of 2003, Regulations Relating to the Management of Human Remains (Government Notice R363), includes the following:

15. *Burial sites and burials*

(2) *All burial sites must comply with the following environmental requirements-*

(a) *be located outside the 100 year floodplain;*

(b) be located at least 350m from ground water sources used for drinking purposes and 500m from the nearest habitable building;

(c) ...

Even though there are examples of cemetery sites that have been established within these zones since the above regulations came into effect proceeding with an application for establishing a cemetery site within these zones is a risk if the relevant authorities cannot be convinced of the need and impact of such development. The De Novo site (property of the Department of Transport and Public Works) was excluded due to uncertainty regarding the long term planning of the property.

Both sites (Louw's Bos and Culcatta Bos) require the following approvals:

- Environmental Authorization (in terms of the National Environmental Management Act, 107 of 1998, Environmental Impact Assessment Regulations)
- Water Use Licensing (in terms of the National Water Act, 36 of 1998)
- Land Use Approval (in terms of the Stellenbosch Land Use Planning By-Law)

The process of acquiring all 3 sets of approvals for both sites have commenced and are at different stages of conclusion.

## 5. RECOMMENDATION

that the report on the status of the project: Identification and acquisition of authorisations and approvals for the establishment of one or more regional cemeteries for Stellenbosch Municipality, be noted.

## 6. DISCUSSION / CONTENTS

### 6.1 Background

The provision and maintenance of cemeteries, funeral parlors and crematoria is a function vested in local government in terms of Schedule 5 (Part B) of the Constitution of the Republic of South Africa, 108 of 1996.

Stellenbosch Municipality (the Municipality), like most of its neighboring local authorities, have a shortage in burial space. A 2012 SALGA report<sup>1</sup> on the status of cemeteries in South African Cities indicated, at that stage, in most municipalities less than 50% of its cemeteries still had capacity for burials. Primary challenges in this regard are:

- shortage of land for more cemeteries,
- insufficient budget for the development of cemeteries,
- the high rate of conventional / traditional burials, and
- resistance by communities to alternative forms of burial.

In reaction to the shortage of burial space the Municipality during 2016 started with a project of identifying and developing one or more regional cemetery sites within the WC024 area to provide for the whole of the municipality for the foreseeable future.

---

<sup>1</sup> The State of Cemeteries in South African Cities (SALGA, 2012)

---

## 6.2 Discussion

### History

The Municipality's burial space in existing cemeteries are under pressure. The development of suitable cemetery sites to provide capacity in this regard has become critical.

An Item (listed under #6.6 below and attached under Annexure 1) that served before Council during 2015 reported the status of burial space within the Municipality and the need to provide for additional burial space. The above Council Meeting resolved that the situation pertaining to burial space in the municipality is acknowledged and that various possible sites be investigated as a solution to the burial space needed. The then Department Planning & Economic Development subsequently initiated a tender process in terms of which the following call for proposals was issued:

- a) *the establishment of a professional team for the identification of suitable sites for the establishment of one or more regional cemetery sites of 30 ha and more within Stellenbosch Municipality;*
- b) *the preparation and the submission of applications for authorisation of a municipal cemetery, including all specialist assessments related to the activities;*
- c) *the planning and design of all related services infrastructure for the cemetery; and*
- d) *the planning and design of the cemetery and establishing a cemetery register in accordance with the layout.*

Bidders were requested to evaluate those cemetery sites as per the above Council Resolution as well as alternative sites that might be identified as being feasible. CK Rumboll & Partners were appointed during June 2016 in the above regard after the tender process was successfully concluded and commenced with the identification and feasibility study of the various sites.

During 2017, after the identification and feasibility study of the various sites were completed, Council resolved (Resolution included under Annexure 2) that it supports the acquisition of the required authorization for the proposed establishment of regional cemeteries (for burial need within WC024) at Farm Culcatta No. 29 and the Remainder of Farm Louw's Bos No. 502 as well as the proposed establishment of a regional cemetery at Farm De Novo No. 727/10 and Portion 1 of Farm Meer Lust No 1006 should the process of acquiring the necessary approval from the Department of Transport and Public Works be acquired. Following the above Council Resolution these sites were included in a Pre-Application (in terms of the National Environmental Management Act, 107 of 1998) process which included a public participation process. This was done to screen out any potential issues that might occur during an official application process.

Of the 4 sites 2 (Louw's Bos and Culcatta Bos) were included in the process of acquiring the necessary environmental and land use approvals for the establishment of a cemetery (see the Memorandum [May 2018] in this regard submitted to the Municipal Manager included under Annexure 3). The 2 remaining sites were (for the time being) excluded from the process after a process of communication with the land owner (Department of Transport and Public Works) and the long term intention of the property could not be established as well as risks associated with the location of the Meerlust site relevant to existing settlements a boreholes.



**Approvals (progress):**

Both sites (Louw's Bos and Culcatta Bos) require the following approvals:

- Environmental Authorization (in terms of the National Environmental Management Act, 107 of 1998, Environmental Impact Assessment Regulations)
  - Water Use Licensing (in terms of the National Water Act, 36 of 1998)
  - Land Use Approval (in terms of the Stellenbosch Land Use Planning By-Law)
- Environmental Authorization

Applications for Environmental Authorization to the Department of Environmental Affairs and Development Planning for both sites followed a range of specialist studies including geological, archaeological, paleontology, freshwater, heritage, visual, botanical and geohydrological assessments conducted.

Louw's Bos: Environmental Authorisation (EA) issued 22 January 2020 (Annexure 4). The above EA issued by the Department of Environmental Affairs and Development Planning was appealed against by a group of landowners in the vicinity of the proposed development. Stellenbosch Municipality has, through its appointed Environmental Assessment Practitioner, submitted its corresponding papers and is awaiting the decision from the Minister on the appeal received.

Culcatta Bos: Environmental Authorisation issued 20 September 2019 (Annexure 5).

Water Use Licensing

Applying for water use includes a number of phases (Pre-Application Phases / Phase 1: Pre-Application Meeting / Phase 2: Draft Application / Phase 3: Final Submission).

Louw's Bos: Draft Application was submitted to the Department Water and Sanitation September 2019. We are awaiting feedback from the Department Water and Sanitation to proceed to Phase 3.

Culcatta Bos: Final Submission to the Department Water and Sanitation has been made November 2019. A decision on the application is expected by the end of 2020.

Land Use Approval

As both sites are the property of the Municipality both land use applications were referred to the Municipal Planning Tribunal for a decision.

Louw's Bos: Land use application approved by the Municipal Planning Tribunal on 28 August 2020 (Annexure 6).

Culcatta Bos: Land use application approved by the Municipal Planning Tribunal on 26 June 2020 (Annexure 7).

**Planning**

Both sites are planned in a manner that does not conform to the traditional way people think of graveyards (as areas used solely for burial purposes, i.e. predominantly rows of graves), but rather as memorial parks visited for a range of activities other than burials. Together these sites will consist of a combined area of 30 hectare of burial space (traditional graves).

During the 2017/18 financial year a total number of 810 people were buried in the Municipality. This equates to 67.5 burials per month. The general formula for calculating traditional grave (i.e. interment) space, as set out by the Western Cape Department of Environmental Affairs and Development Planning, is determined at 2 000 graves per hectare or alternatively 5m<sup>2</sup> per traditional grave, including 10% for circulation. In the planned Louw's Bos cemetery and memorial park alone, approximately 20 hectare is proposed for use as traditional grave space. Using the formula provided by the Department of Environmental Affairs and Development Planning, 39 940 traditional graves may be provided for as set out below.

$$19.97 \text{ ha} \times 2\,000 = 39\,940 \text{ graves} \quad 39\,940/810 = \mathbf{49 \text{ years}}$$

$$199\,700 / 5\text{m}^2 = 39\,940 \text{ graves}$$

Calculating at an average of 810 deaths per annum, 4 050m<sup>2</sup> grave space per annum will be required. Should the average burials stay more or less the same approximately 12.15 hectare of land will be required over the next 30 years. The planned Louw's Bos regional site should provide sufficient traditional interment space for approximately the next 49 years.

### **6.3 Financial Implications**

On completion of this project (acquisition of the approvals), which is expected to conclude during 2020, it is estimated that the establishment / development of the 2 sites will cost in the order of R34 000 000-00 over the next 5 years.

### **6.4 Legal Implications**

The provision and maintenance of cemeteries, funeral parlors and crematoria is a function vested in local government in terms of Schedule 5 (Part B) of the Constitution of the Republic of South Africa, 1996 (Act 108 of 1996).

### **6.5 Staff Implications**

This report has no staff implications to the Municipality. Given the size of the 2 cemetery sites additional dedicated staff will have to be appointed for the day-to-day maintenance and upkeep of both sites.

### **6.6 Previous / Relevant Council Resolutions:**

**27<sup>TH</sup> Council Meeting: 2015-02-25: Item 7.4**

**RESOLVED** (nem con)

- (a) that the current situation pertaining to burial space in WC024, be noted by Council; and
- (b) that the following sites which were identified, be investigated as a solution to the critical burial space needed:
  - i. Erf 619/1: Municipal owned land zoned for agricultural use. This land is approximately 29 ha not in lease currently.
  - ii. Louw's Bos plantation: The plantation operation has been stopped and the area is currently Fynbos area.
  - iii. De Novo existing cemetery is owned by Department of Transport and Public Works.
  - iv. Franschoek Valley: La Motte – Farm 1339/1 (Public Works).
  - v. Wemmershoek: Farm 1024/1 (Stellenbosch Municipality).

- 
- vi. Dennegeur: Erf 3666 (Private).
  - vii. Klapmuts: Farm 748/40 (Private).
  - viii. Stellenbosch: Onder Papegaaiberg – Re Farm 183 (Stellenbosch Municipality)
  - ix. Jamestown: Farm 1166 (Private).

**8<sup>TH</sup> COUNCIL MEETING: 2017-04-26: ITEM 7.3.2****RESOLVED** (nem con)

- (a) that Council amends its 27th Meeting of the Council of Stellenbosch (25 February 2015) resolution by adding (b)(x) to include any alternative land in the same area which could feasibly be used as a site to be investigated as a solution to the critical need for burial space within Stellenbosch Municipality;
- (b) that Council supports the acquisition of the required authorization for the proposed establishment of regional cemeteries (for burial need within WC024) at Farm Culcatta No. 29 and the Remainder of Farm Louw's Bos No. 502 as well as the proposed establishment of a regional cemetery at Farm De Novo No. 727/10 and Portion 1 of Farm Meer Lust No 1006 should the process of acquiring the necessary approval from the Department of Transport and Public Works be acquired;
- (c) that the possible creation of a garden of remembrance as alternative to a traditional land site also be investigated; and
- (d) that Council authorises the Municipal Manager to proceed with acquiring the necessary approvals for the establishment of the above cemeteries.

**6.7 Risk Implications**

The direct risk to the Municipality is the reality that the WC024 cemeteries have reached its capacity and will run out of burial space over the next few years.

**RECOMMENDATION FROM THE EXECUTIVE MAYOR, IN CONSULTATION WITH THE EXECUTIVE MAYORAL COMMITTEE, TO COUNCIL: 2020-11-17: ITEM 7.6.2**

that the report on the status of the project: Identification and acquisition of authorisations and approvals for the establishment of one or more regional cemeteries for Stellenbosch Municipality, be noted.

**ANNEXURES**

- Annexure 1: Council Resolution 2015
- Annexure 2: Council Resolution 2017
- Annexure 3: Memorandum to the Municipal Manager (May 2018)
- Annexure 4: Environmental Authorisation (Louw's Bos) (22 January 2020)
- Annexure 5: Environmental Authorisation (Culcatta Bos) (20 September 2019)
- Annexure 6: Municipal Planning Tribunal Meeting Minutes (28 August 2019)
- Annexure 7: Municipal Planning Tribunal Meeting Minutes (26 June 2019)

# APPENDIX 1

**7.4 EXTENTION OF BURIAL SPACE***File number* : 16/6/1*Compiled by* : *Manager: Community Services & Acting Head:  
Parks, Rivers & Area Cleaning**Report by* : *Director Community & Protection Services**Delegated Authority* : *Council****Strategic intent of item***

Preferred investment destination	<input type="checkbox"/>
Greenest municipality	<input checked="" type="checkbox"/>
Safest valley	<input type="checkbox"/>
Dignified Living	<input checked="" type="checkbox"/>
Good Governance	<input type="checkbox"/>

**1. PURPOSE OF REPORT**

To inform Council of:

- (a) the critical need for burial space in the Greater Stellenbosch; and
- (b) the outcome of the workshop held on 30 October 2014.

**2. BACKGROUND**

Due to the increase of population growth in the Greater Stellenbosch, the existing burial space in cemeteries is under severe pressure and will soon reach full capacity. Contributing factors are the conventional burial methods, which is still preferred above other burial methods which include cremation and liquid burials. This phenomenon is further enhanced by the capacity of cemeteries reached by the neighboring towns such as City of Cape Town, Drakenstein and Overstrand Municipality.

The Municipality started with its first investigation to extend burial space in 2006. Dennis Moss Partnership was appointed to identify areas for possible development.

The finding of the report was considered by Council and five areas were recommended where the need was most urgent, subject to the condition to utilize Council owned land to avoid cost of purchasing land.

The areas identified were Onder-Papegaaiberg, Klapmuts, Pniel/Kylemore, La Motte and Jamestown.

#### FINDINGS OF DENNIS MOSS SURVEY 2006

Name of cemetery	Investigation outcomes	Alternative burial space to be used
Onder-Papegaaiberg	Existing cemetery	Continue to bury in informal plantation area used for children grave blocks
Klapmuts	No Municipal owned land for burial space	Existing cemetery on private property
Pniel	No Municipal land	Cemetery belongs to Congregational Church
Kylemore	Cemetery belongs to the Old Apostolic Church and Municipal public open space	Both cemeteries are in operation
La Motte	Municipal owned land	Cemeteries are in operation
Jamestown	Municipal owned land with available space earmarked for housing development	Cemeteries are in operation

The Department of Public Works granted permission to proceed with the study (Environmental Impact Assessment) for La Motte.

As a first phase for the extension of burial space, a consultant was appointed in 2008 to conduct the prescribed studies to meet the legal requirements for Onder-Papegaaiberg, Kylemore and La Motte.

Subsequent to these applications submitted to the Department of Environment Affairs and Development Planning (DEADP), the application for Kylemore Village was approved. The Property Manager has applied for consolidation of the different erven contained in the approval. The relevant ervens are 9, 21, 22, 34, 35, 36 and 71 Kylemore. **(APPENDICES 1 and 2)**

The La Motte application was rejected by the Department of Water Affairs and due to this rejection the Department decided not to proceed with the process. **(APPENDIX 3)**

Onder-Papegaaiberg's application has not been finalized yet, pending a final decision on the land use by Council. Two applications were submitted to DEADP, one being for the extension of burial space on a portion of the land and the other for the declaration of the entire area as a Nature Reserve.

**3. DISCUSSION**

In October 2014 a Cemetery workshop was conducted with an aim of finding possible solutions to the shortage of burial space. The attendees included Councilors, Municipal officials and External experts in cemetery management. The discussions were overwhelmed with finding sufficient space which should at least be 30 hectares or more for the development of proper burial space. The development should include various alternative burial methods such as:

- Landscaped grid areas: grassed surface with a plaque
- Sculpture and tombstone areas: high cost area
- Medium costs areas: landscape with flower areas
- Low costs areas: general accepted grave sites
- Pauper burial sites

**3.1 Current capacity**

The Department Community Services conducted a base line assessment of the available space and projected the operations in terms of number of grave sites.

CEMETERY SITE	% OF LAND USE AS GRAVE SITES	REMAINING GRAVE SITES (ESTIMATED)
Onder-Papegaaiberg	98%	150 pre-booked graves
Jamestown	98%	300 graves
Pniel	98%	30 graves
Franschhoek	10% of 2ha	1000 graves
Wemmershoek	98%	20 graves
Groendal	98%	38 graves
Kylemore	95%	20 graves
Klapmuts	Reached capacity	-

**3.2 Possible land identified during the workshop**

The Department Community Services proceeded beyond the call by Council to investigate only the five identified areas in the Dennis Moss report for alternative burial sites.

In collaboration with the Congregational Church of Pniel, the Municipality and Boschendal Treasury Trust (BTT), Boschendal subsequently donated land adjacent to the existing cemetery as additional space.

The Boschendal Estate donated additional burial space on portion 13 of their farm Boschendal 1674. This offer was accepted and the application for rezoning was submitted.

- Erf 619/1: Municipal owned land zoned for agricultural use. This land is approximately 29 ha not in leased currently. **(APPENDIX 4)**
- "Louw's Bos" plantation: The plantation operation has been stopped and the area is currently Fynbos area. **(APPENDIX 5)**
- De Novo existing cemetery is owned by The Department of Transport and Public Works.

#### 4. LEGAL IMPLICATION

##### Regulatory context

Constitution of the Republic of South Africa 1996 Part B of Schedule 5 of the Constitution provides that cemeteries, crematoria and funeral parlours are local government matters. Local government has a Constitutional and statutory duty to regulate Cemeteries, crematoria and funeral parlours, to provide for the internment of human remains in a dignified manner.

#### 5. FINANCIAL IMPLICATION

Budget requirements must be dealt with through the budget process.

#### 6. COMMENTS FROM OTHER RELEVANT DEPARTMENTS

##### 6.1 Planning Department

The Boschendal Estate application for rezoning must, like any other sites, be preceded by a full environmental authorization application. There is no sense in incurring costs and considering rezonings if the site does not meet the strict cemetery specifications.

The Directorate must make available the required budget, estimated at roughly R2,4 million over two financial years to the Planning and Economic Development Directorate, to proceed with the gaining of the required approvals and authorisations for the establishment of one or more regional or sub-regional cemeteries. P&ED will then manage the process and ensure that suitable cemetery space is identified and planned by commencement of the 2017/18 financial year.

##### 6.2 Property Management

As is mentioned in the report, we are in the process of acquiring various portions of land in the Dwarsrivier area, being Pniel, Lanquedoc and Kylemore.



This Department is not in support of the two (2) options mentioned in par. 3.2, i.e Erf 619/1 (Portion 1 of Farm 619) and Louw's Bos (Portion of Farm 502). Farm 619/1 is situated 2km from the Annandale road with limited access (gravel road), whilst Louw's Bos, next to the Airfield, have other, more option potential.

This department would suggest the following sites based on the principle of "*building on whilst is already in place*", rather than developing new burial sites:

Franschhoek Valley:	La Motte:	Farm 1339/1:	Public Works
	Wemmershoek:	Farm 1024/1:	Stellenbosch Municipality
Dennegeur:	Erf 3666:	Private	
Klapmuts:	Next to existing site:	Farm 748/40:	Private
Stellenbosch:	Onder Papegaaiberg:	Rem Farm 183:	Stellenbosch Municipality
Jamestown:	Next to existing site:	Farm 1166:	Private

The areas are shown on **APPENDICES 6 - 8**.

#### RECOMMENDED

- (a) that the current situation pertaining to burial space in WCO24, be noted by Council; and
- (b) that the sites which were identified, be investigated as a solution to the critical burial space needed.

#### (DIRECTOR: COMMUNITY AND PROTECTION SERVICES TO ACTION)

#### COMMUNITY AND PROTECTION SERVICES COMMITTEE: 2015-02-11: ITEM 5.1.1

#### RECOMMENDED

- (a) that the current situation pertaining to burial space in WCO24, be noted by Council; and
- (b) that the following sites which were identified, be investigated as a solution to the critical burial space needed:

Franschhoek Valley:	La Motte:	Farm 1339/1:	Public Works
	Wemmershoek:	Farm 1024/1:	Stellenbosch Municipality
Dennegeur:	Erf 3666:	Private	
Klapmuts:	Next to existing site:	Farm 748/40:	Private

---

Stellenbosch:	Onder Papegaaiberg:	Rem Farm 183:	Stellenbosch Municipality
Jamestown:	Next to existing site:	Farm 1166:	Private

**(DIRECTOR: COMMUNITY AND PROTECTION  
SERVICES TO ACTION)**

**MAYORAL COMMITTEE MEETING: 2015-02-18: ITEM 5.1.4**

**RECOMMENDED BY THE EXECUTIVE MAYOR**

- (a) that the current situation pertaining to burial space in WCO24, be noted by Council; and
- (b) that the following sites which were identified, be investigated as a solution to the critical burial space needed:
  - (i) Erf 619/1: Municipal owned land zoned for agricultural use. This land is approximately 29 ha not in leased currently.
  - (ii) "Louw's Bos" plantation: The plantation operation has been stopped and the area is currently Fynbos area.
  - (iii) De Novo existing cemetery is owned by Department of Transport and Public Works.
  - (iv) Franschhoek Valley: La Motte: Farm 1339/1: Public Works
  - (v) Wemmershoek: Farm 1024/1: Stellenbosch Municipality
  - (vi) Dennegeur: Erf 3666: Private
  - (vii) Klapmuts: Next to existing site: Farm 748/40: Private
  - (viii) Stellenbosch: Onder Papegaaiberg: Rem Farm 183: Stellenbosch Municipality
  - (ix) Jamestown: Next to existing site: Farm 1166: Private

**(DIRECTOR: COMMUNITY AND PROTECTION  
SERVICES TO ACTION)**

**27<sup>TH</sup> COUNCIL MEETING: 2015-02-25: ITEM 7.4****RESOLVED** (nem con)

- (a) that the current situation pertaining to burial space in WCO24, be noted by Council; and
- (b) that the following sites which were identified, be investigated as a solution to the critical burial space needed:
  - (i) Erf 619/1: Municipal owned land zoned for agricultural use. This land is approximately 29 ha not in leased currently.
  - (ii) "Louw's Bos" plantation: The plantation operation has been stopped and the area is currently Fynbos area.
  - (iii) De Novo existing cemetery is owned by Department of Transport and Public Works.
  - (iv) Franschhoek Valley: La Motte: Farm 1339/1: Public Works
  - (v) Wemmershoek: Farm 1024/1: Stellenbosch Municipality
  - (vi) Dennegeur: Erf 3666: Private
  - (vii) Klapmuts: Next to existing site: Farm 748/40: Private
  - (viii) Stellenbosch: Onder Papegaaiberg: Rem Farm 183: Stellenbosch Municipality
  - (ix) Jamestown: Next to existing site: Farm 1166: Private

**(DIRECTOR: COMMUNITY AND PROTECTION  
SERVICES TO ACTION)**

**ITEM 7.4**

**APPENDICES 1-8**

**EXTENTION OF BURIAL SPACE**

**27<sup>TH</sup> COUNCIL MEETING:  
2015-02-25**

# APPENDIX 1

APPENDIX 1



**STELLENBOSCH**  
STELLENBOSCH • PNIEL • FRANSCHHOEK

MUNICIPALITY • UMASIPALA • MUNISIPALITEIT

2012-09-14

The Manager: Property Management  
Department of Transport & Public Works  
Provincial Government of the Western Cape  
9 Dorp Street  
Cape Town  
8001

Dear Mrs Koeries

**PROPOSED ACQUISITION OF A NUMBER OF ERVEN IN KYLEMORE FOR THE PURPOSE OF A CEMETERY**

**1. Background**

On 22 January 1987 the then Regional Director of the Administration: House of Representatives, wrote to the Secretary of the Divisional Council, indicating that they are willing to sell a portion of Remainder Farm 124/33 (Now erf 9, Kylemore) to the Divisional Council for the purchase price of R2.00, for the purposes of a cemetery. Hereto attached as **APPENDIX 1**, a copy of the said letter. I have no records whether this proposal was indeed considered by the Divisional Council.

During 1994 Stellenbosch Municipality took over the Management of the Kylemore area. During 1999 an agenda item served at the Executive Committee meeting, where it was decided to inform the Department of Planning, Local Government and Housing that "*the matter is under investigation*" (the management of the cemetery). A copy of the agenda item, setting out the history of the cemetery, is attached as **APPENDIX 2**. Again, I can find no record that the matter was indeed taken up with the Department.

Since then the area is managed on a informal basis by the various churches in the community.

**2. Environmental Authorisation**

During 2011 a consultant was appointed to do a basic assessment with the view of extending the existing cemetery in Kylemore. On 2011-06-22 an Environmental Authorisation was issued by the Provincial Department of Environmental Affairs & Development a copy of which is attached as **APPENDIX 3**. The area (property) identified in this authorisation consist of erven 9,21,22,34,35,36 and 71, Kylemore, as shown on General Plan No 12164, a copy of which is attached as **APPENDIX 4**.

3. De Facto situation

The de facto situation is that the area referred to above, and not only erf 9, is effectively used as an informal cemetery, as can be seen on Fig 1, below.



Fig 1: Aerial photo of area

Hereunder a list of the erven mentioned above, with an indication of ownership:

Erf number	Size	Ownership*
9	9271m <sup>2</sup>	Provincial Housing Development Board
21	13115 ha	Stellenbosch Municipality
22	2771m <sup>2</sup>	Provincial Housing Development Board
34	356m <sup>2</sup>	National Housing Board
35	350m <sup>2</sup>	National Housing Board
36	4190m <sup>2</sup>	National Housing Board
71	1834m <sup>2</sup>	Old Apostolic Church of Africa

\*See Deeds Search results attached as **APPENDIX 5**.

From the above it is clear that there are three (3) owners involved, i.e.:-

Stellenbosch Municipality : Erf 21, measuring 13115m<sup>2</sup>

Provincial Housing Development Board : Erven 9, 22, 34, 35 and 36  
measuring 16938m<sup>2</sup> and  
Old Apostolic Church of Africa : Erf 71, measuring 1834m<sup>2</sup>

**4. Request to acquire land**

We hereby request that erven 9, 22, 34, 35 and 36 be made available/transferred to Stellenbosch Municipality for the purpose of using/managing it as a cemetery. Please note that Stellenbosch Municipality, for all practical purposes, is already managing the entire area as a cemetery.

We await your urgent feedback in this regard.

Yours faithfully



.....  
**PIET SMIT**  
**MANAGER: PROPERTY MANAGER**

cc: Johan Le Roux



# APPENDIX 2

APPENDIX 2



# APPENDIX 3

APPENDIX 3



**water affairs**

Department:  
Water Affairs  
REPUBLIC OF SOUTH AFRICA

Private Bag X16, Sanlamhof, 7532 / 52 Voortrekker Road, Bellville, 7530  
Tel. (021) 941 6143 Fax: (021) 950 7224

Enquires: Blantina Masela,  
Call: 082 3292 736,  
E [maseleb@dwa.gov.za](mailto:maseleb@dwa.gov.za),  
16/277/G10A/A11

Attention: NZ Loebenberg

Cape Lowlands Environmental Services  
P.O. Box 70  
DARLING  
7345

Dear Sir/Madam

**FINAL BASIC ASSESSMENT REPORT; PROPOSED CONSTRUCTION OF LA MOTTE VILLAGE CEMETERY ON FARM NO. 1339/1, STELLENBOSCH**

Your report dated 13 January 2012 with DEA&DP Ref No. E 12/2/4/1/-B4/37-1015/11 refers.

This Department has reviewed your report and wishes to inform you on the following conditions concerning the proposed development:

1. The requirements of the Department of Water Affairs are that graveyards should not be:
  - located below the 1 in 50 year floodline of a river;
  - in close proximity to water bodies such as wetlands, vleis, pans, estuaries and floodplains;
  - situated on unstable areas, like fault zones, seismic zones, dolomitic or karst areas where sinkholes and subsidence are likely;
  - situated in or near sensitive ecological areas;
  - situated in or on areas characterised by flat gradients, shallow or emergent groundwater;
  - situated in areas characterised by steep gradients, or shallow bedrock with little soil cover, where stability of slopes could be a problem;
  - situated in areas of ground water recharge on account of topography and/or highly permeable soils; and
  - situated on areas overlaying or adjacent to important or potentially important aquifers (Parsons aquifer classification), where such aquifers are to be used for water supply purposes.
2. It has been noted that the site is characterised by a high water table and might be affected by the proposed development. Please refer to the Geohydrological comments attached. This office does not support the proposed activity.
3. All relevant sections and regulations of the National Water Act, 1998 (Act 36 of 1998) regarding water use must be adhered to.

Should there be any queries, please do not hesitate to contact this office.

Yours faithfully

*AM Schneider*  
of CHIEF DIRECTOR: WESTERN CAPE

DATE: 23 April 2012

# APPENDIX 4

APPENDIX 4

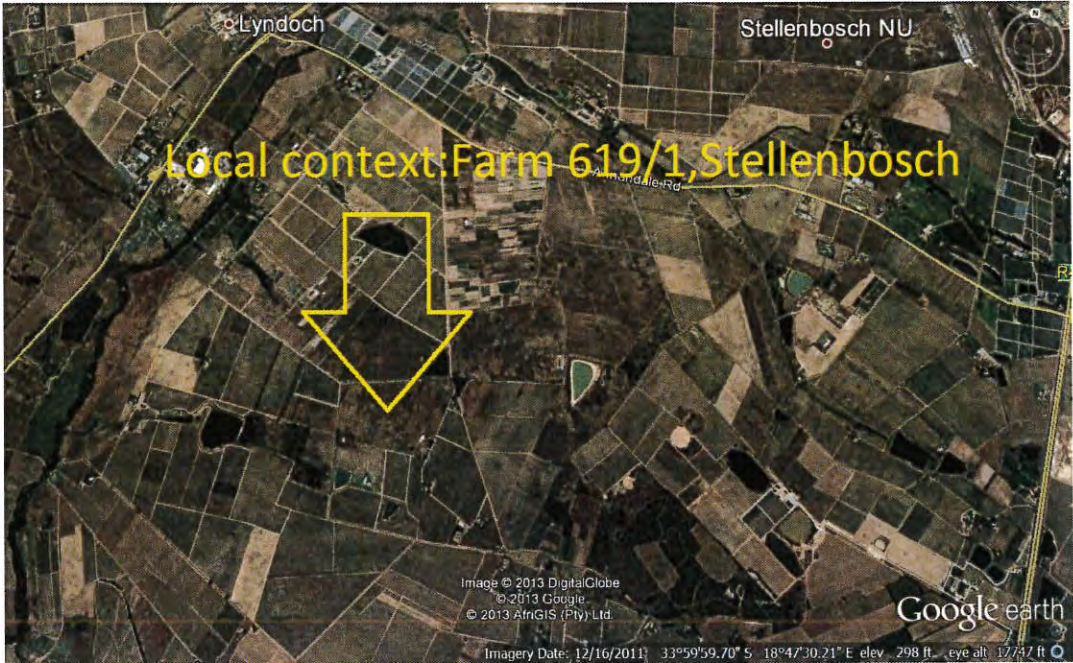

# APPENDIX 5



APPENDIX 5

**LOUWS BOS PLANTATION**



<b>ERF Number</b>	Farm 502 (portion of) with agricultural zoning.
<b>Size</b>	42.8 ha

# APPENDIX 6

Appendix 6

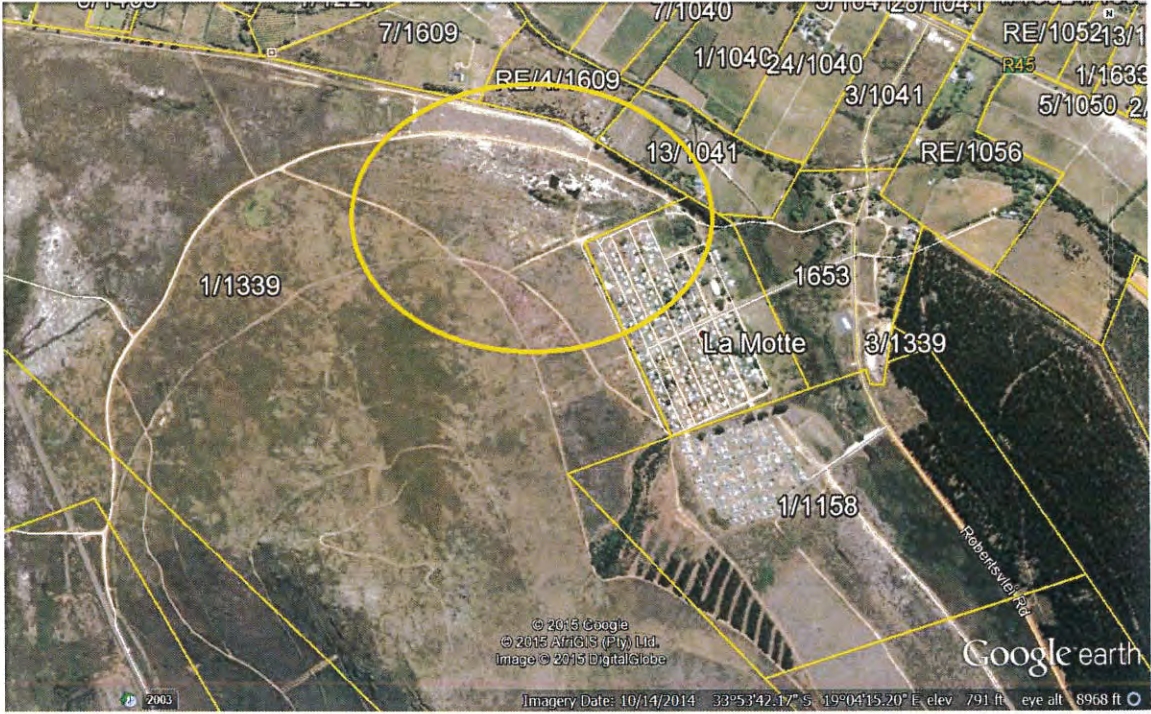

La Motte

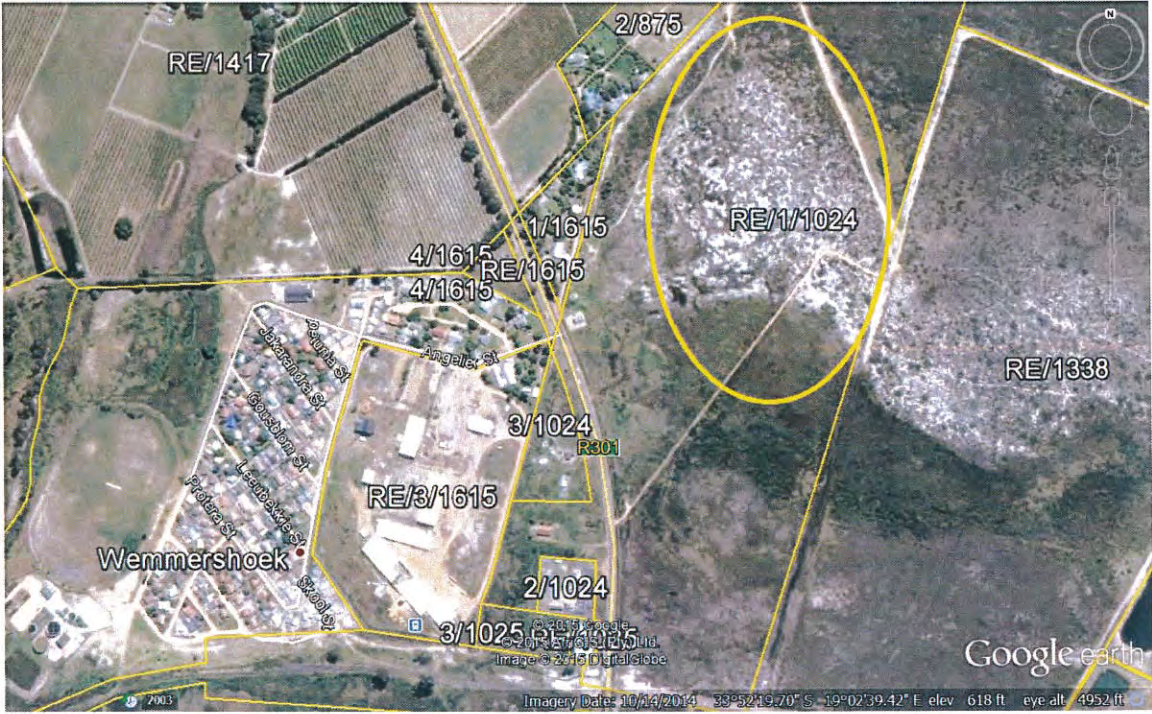

Wemmershoek

# APPENDIX 7

Appendix 7



Dennegeur

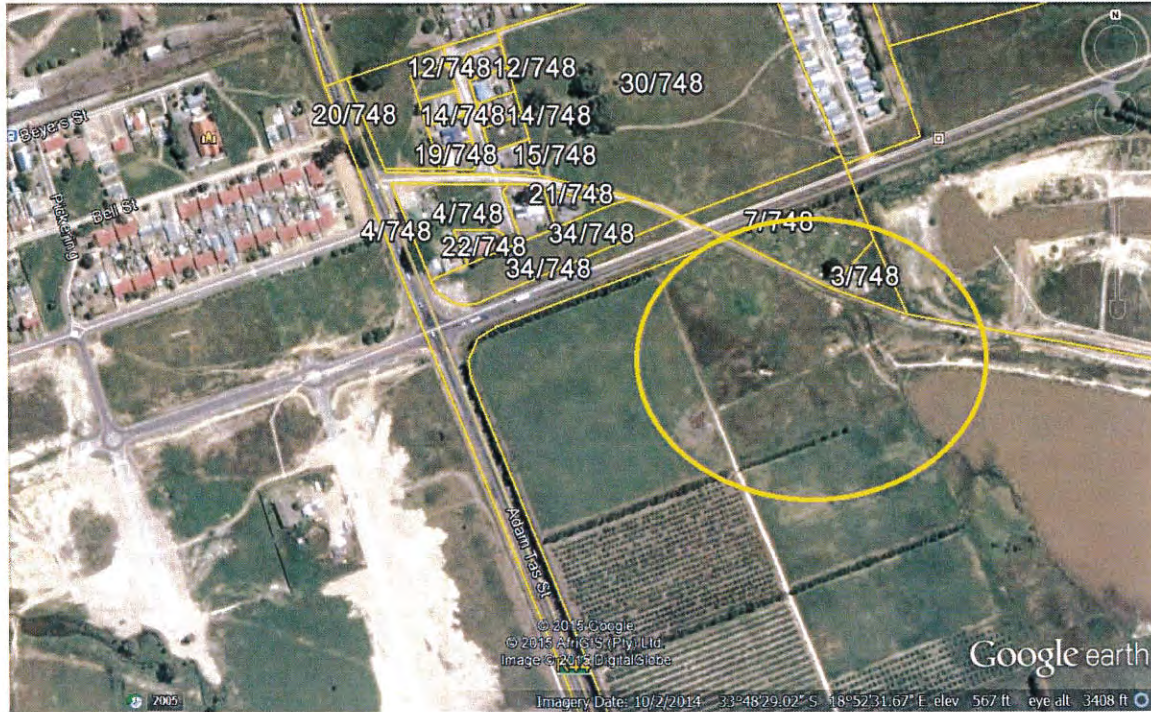

Klapmuts

# APPENDIX 8

Appendix 8

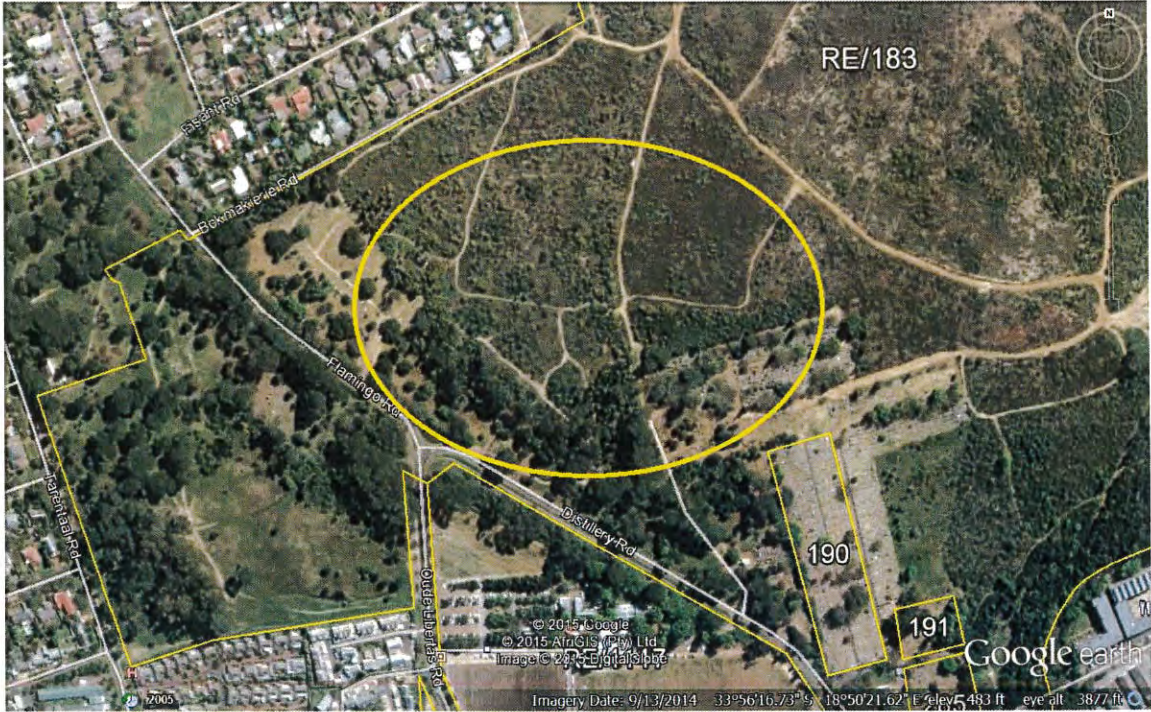

Papegaaiberg



Jamestown

# APPENDIX 2





**STELLENBOSCH**

STELLENBOSCH • PNIEL • FRANSCHHOEK

MUNICIPALITY • UMASIPALA • MUNISIPALITEIT

Ref no.3/4/1/5

2017-05-12

## **MINUTES**

### **8<sup>TH</sup> MEETING OF THE COUNCIL OF STELLENBOSCH MUNICIPALITY**

**2017-04-26 AT 10:00**

Detailed account of the meeting proceedings is available on audio recording, which is obtainable from The Municipal Manager's Office per Request for Information (RFI)

7.3.2	<b>STELLENBOSCH MUNICIPALITY: EXTENSION OF BURIAL SPACE</b>
-------	---

### 1. PURPOSE OF THE REPORT

To inform Council of the status of the above project, the result of the feasibility study conducted in the process of identifying new cemetery sites, and to obtain Council's approval to commence with the process of developing the proposed sites as cemeteries.

### 2. BACKGROUND

The provision and maintenance of cemeteries, funeral parlours and crematoria is a function vested in local government in terms of Schedule 5 (Part B) of the Constitution of the Republic of South Africa, 1996 (Act 108 of 1996).

The Greater Stellenbosch Municipality's (the municipality) burial space in cemeteries is under pressure. The development of suitable cemetery sites to provide capacity in this regard has become critical.

An Item that served before Council on the 27<sup>th</sup> Meeting of the Council of Stellenbosch (25 February 2015) (**APPENDIX 1**) reported the status of burial space within the municipality and the need to provide for additional burial space mainly due to the increase in population growth within the municipality, cultural beliefs as it pertains to dealing with the deceased and the fact that neighbouring municipality's, the City of Cape Town, Drakenstein and Overstrand, cemeteries have also reached capacity.

The above Council Meeting resolved that the situation pertaining to burial space in the municipality is acknowledged and that various possible sites be investigated as a solution to the burial space needed.

The Department Planning & Economic Development subsequently initiated a tender process in terms of which the following call for proposals was issued:

- a) *the establishment of a professional team for the identification of suitable sites for the establishment of one or more regional cemetery sites of 30 ha and more within Stellenbosch Municipality;*
- b) *the preparation and the submission of applications for authorisation of a municipal cemetery, including all specialist assessments related to the activities;*
- c) *the planning and design of all related services infrastructure for the cemetery; and*
- d) *the planning and design of the cemetery and establishing a cemetery register in accordance with the layout.*

Bidders were requested to evaluate those cemetery sites as per the above Council resolution as well as alternative sites that might be identified as being feasible.

CK Rumboll & Partners were appointed during June 2016 in the above regard after the tender process was successfully concluded and commenced with the identification and feasibility study of the various sites.

### 8<sup>TH</sup> COUNCIL MEETING: 2017-04-26: ITEM 7.3.2

#### RESOLVED (nem con)

- (a) that Council amends its 27th Meeting of the Council of Stellenbosch (25 February 2015) resolution by adding (b)(x) to include any alternative land in the same area which could feasibly be used as a site to be investigated as a solution to the critical need for burial space within Stellenbosch Municipality;
- (b) that Council supports the acquisition of the required authorization for the proposed establishment of regional cemeteries (for burial need within WC024) at Farm Culcatta No. 29 and the Remainder of Farm Louw's Bos No. 502 as well as the proposed establishment of a regional cemetery at Farm De Novo No. 727/10 and Portion 1 of 'Farm Meer Lust No 1006 should the process of acquiring the necessary approval from the Department of Transport and Public Works be acquired;
- (c) that the possible creation of a garden of remembrance as alternative to a traditional land site also be investigated; and
- (d) that Council authorises the Municipal Manager to proceed with acquiring the necessary approvals for the establishment of the above cemeteries.

Meeting: Ref no Collab:	8 <sup>TH</sup> COUNCIL: 2017-04-26 7/2/1/1	Submitted by Directorate: Author Referred from:	Planning & Econ Dev D Lombaard Mayco: 2017-04-19
-------------------------------	--	---	--

# **APPENDIX 3**

11 JUN 2018

Office of the Municipal Manager  
Kantoor van die Munisipale Bestuurder



# MEMORANDUM

*Department Spatial Planning, Heritage and Environment*

*Departement Ruimtelike Beplanning, Erfenis and Omgewing*

---

**To** : Municipal Manager  
**From** : Manager: Spatial Planning Heritage & Environment – Bernabé de la Bat  
**Date** : 31 May 2018  
**File ref.** : 16/6/1  
**Re** : EXTENTION OF BURIAL SPACE – BID 17/16

---

## 1. PURPOSE OF THE MEMORANDUM

The 8<sup>th</sup> Meeting of Council (2017-04-26: Item 7.3.2) resolved:

- (a) that Council amends its 27th Meeting of the Council of Stellenbosch (25 February 2015) resolution by adding (b)(x) to include any alternative land in the same area which could feasibly be used as a site to be investigated as a solution to the critical need for burial space within Stellenbosch Municipality;
- (b) that Council supports the acquisition of the required authorization for the proposed establishment of regional cemeteries (for burial need within WC024) at Farm Culcatta No. 29 and the Remainder of Farm Louw's Bos No. 502 as well as the proposed establishment of a regional cemetery at Farm De Novo No. 727/10 and Portion 1 of Farm Meer Lust No 1006 should the process of acquiring the necessary approval from the Department of Transport and Public Works be acquired;
- (c) that the possible creation of a garden of remembrance as alternative to a traditional land site also be investigated; and
- (d) that Council authorizes the Municipal Manager to proceed with acquiring the necessary approvals for the establishment of the above cemeteries.

CK Rumboll & Partners was appointed in terms of BID 17/16 during 2016 for a process that resulted in the identification of the above proposed regional cemetery sites. Further to such identification process the appointment included the acquisition of the required authorization for cemetery establishment on two (2) sites.

The purpose of this memorandum is to report on the progress made in terms of the above project and to acquire the Municipal Manager's approval on the two (2) recommended sites upon which formal application for the required authorization for cemetery establishment will follow.

## **2. CEMETERY SITES**

During January 2018 the Department Spatial Planning, Heritage & Environment through its appointed consultant, CK Rumboll & Partners, commenced with the acquisition of Environmental Authorization in terms of the National Environmental Management Act, 107 of 1998 (NEMA), Environmental Impact Assessment Regulations, for the establishment of regional cemetery sites at the above locations.

To manage risk, especially with respect to possible future wasteful expenditure, a pre-application process as allowed in the above regulations was undertaken before a formal process for Environmental Authorization is launched. This process has allowed the municipality to advertise all the sites and the intention of possible cemetery establishment in the local newspapers.

Three of the four sites formed part of the process. The Farm De Novo No. 727/10 was excluded due to the uncertainty on the landowner's, Department of Roads & Public Works, side as to the future use of the property.

A 60-day period was allowed for interested and affected parties to register and submit comment. During this time the municipality and its consultants were also able to conduct further studies into the feasibility of the use of the sites for the intended purpose. The 60-day commenting period has concluded.

The next step will be the formal application to the Department of Environmental Affairs & Development Planning in terms of NEMA for Environmental Authorization as well as an application to the Department of Water and Sanitation for a Water Use License where required.

The following information relevant to the three remaining possible sites must be noted at this point:

### **2.1 LOUW'S BOS**

Stellenbosch Municipality owns Farm Louw's Bos No. 502. Farm Louw's Bos No. 502 is a large track of land south-west of Stellenbosch town (De Zalze), west of the R44 and along the Annendale Road (see Figure 1 on the following page). This property includes the Stellenbosch Airfield precinct.

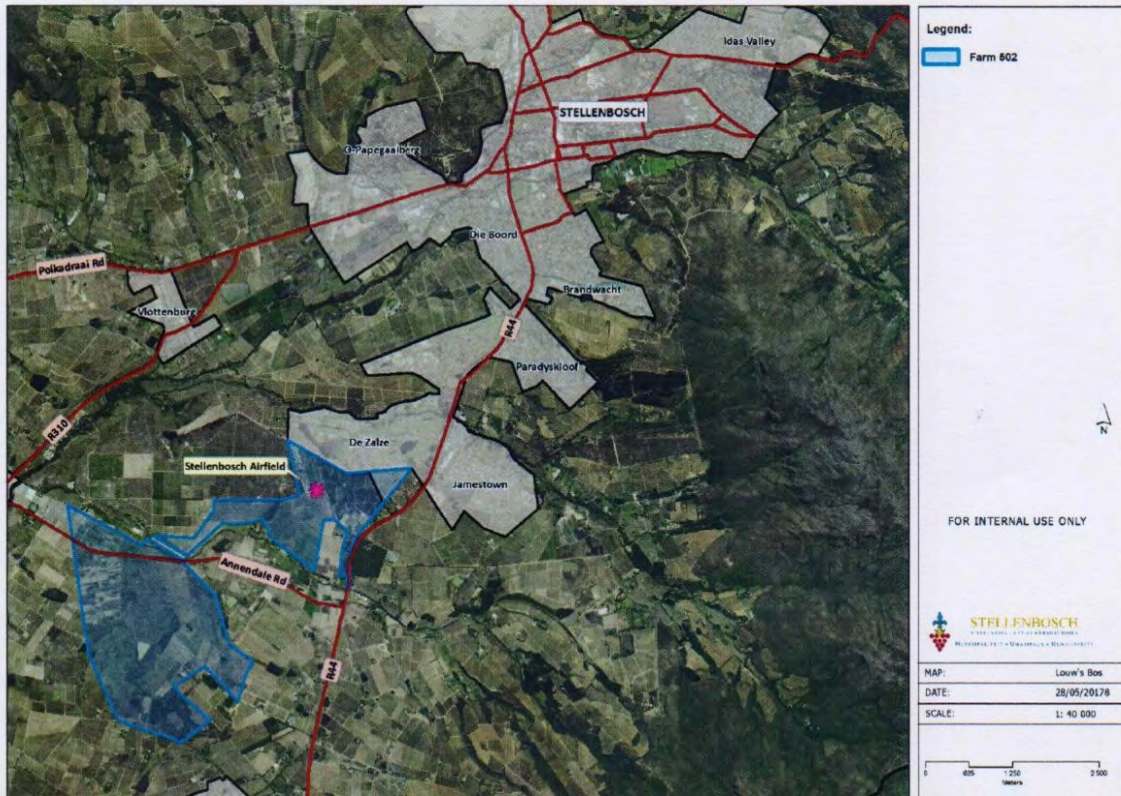

Figure 1: Farm Louw's Bos No. 502

This property is located in what has been identified in the cemetery study (Identification and Acquisition of Authorisations and Approvals for the establishment of One or More Regional cemeteries for Stellenbosch Municipality, CK Rumboll & Partners, October 2016) as the "Central District" ideally located to provide for burial space in an area within Stellenbosch Municipality where the highest concentration of its population is located.

Initially only the portion immediately south of the Stellenbosch Airfield (north of the Annendale Road) was investigated for possible cemetery establishment. This area is marked as Area "A" in Figure 2 on the following page. However, a portion of property immediately south of the Annendale Road, Area "B" was also recently identified by the municipality's Property Management section. Because Area B presents some advantages over the development of Area A as a regional cemetery site this option is also dealt with as part of this memorandum and recommendations.

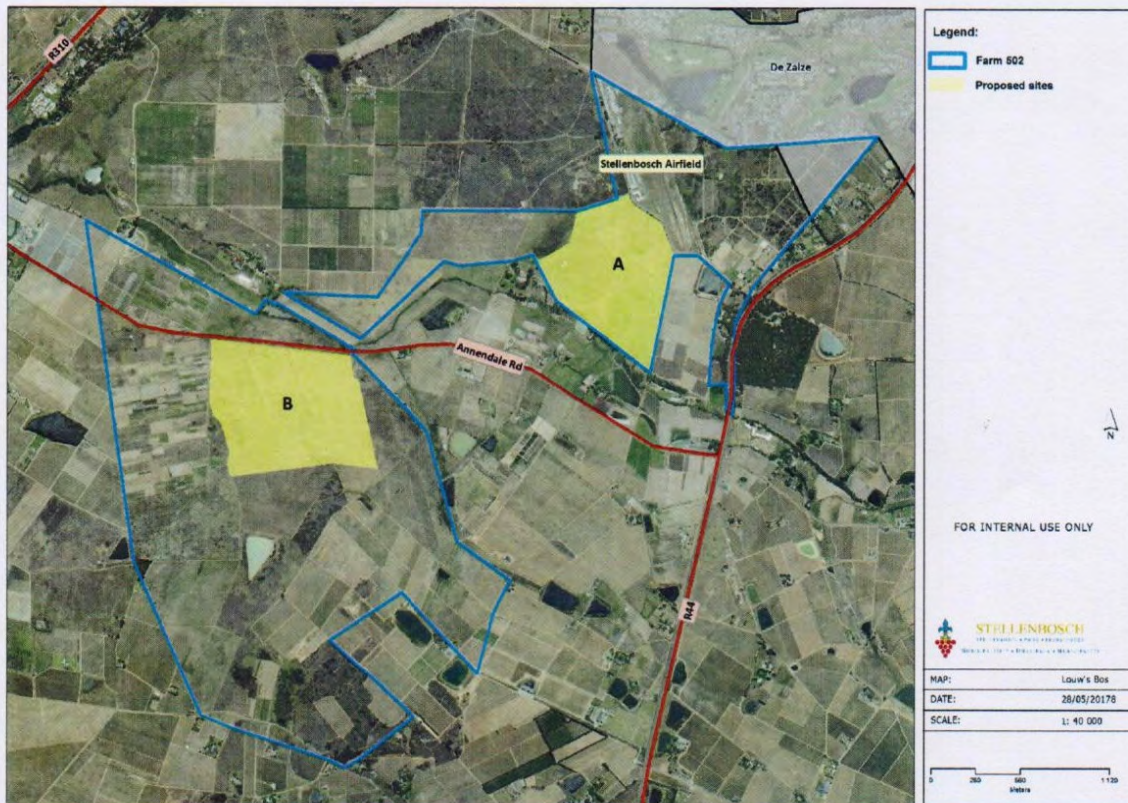

Figure 2: Proposed sites on Farm Louw's Bos No. 502

The main concerns that were identified during the above public participation process, relevant to Farm Louw's Bos No. 502 was the following:

- Access will need to be provided
- Possible congestion on the Annendale Road
- Potential ground water/surface water contamination
- Potential Western By-Pass
- Potential Airfield expansion
- Loss of high potential agricultural land
- Conservation of natural vegetation

2.1.1 Site Advantages

	Area A	Area B
<u>Location</u>	Located close to Stellenbosch town.	Located close to Stellenbosch town.
<u>Access</u>		Directly off the Annendale Road onto municipal land.
<i>Notes:</i>	Access from the R44 and via the existing access road to the Stellenbosch Airfield will	



	not be possible. Access will have to be gained from the Annendale Road.	
<u>Area size</u>	±30ha. Large enough to accommodate a regional cemetery site.	±35ha. Large enough to accommodate a regional cemetery site.
<u>Biophysical</u>	Biophysically the site is suitable for cemetery establishment. Soil-type is granite.	Although the biophysical characteristics of Area B need to be confirmed, the indications, similar to that of Area A, are that the site is suitable for cemetery establishment.  The available land offers more gradual slopes (compared to Area A) which impact on the storm water management. This may have cost implications in the long term.
<u>Land Use</u>	No water rights registered on the property. The property is underutilized and lying fallow.	Water rights registered on the property could be used for agricultural purposes and upkeep of the cemetery.

### 2.1.2 Site Challenges

	Area A	Area B
<u>Access</u>	No option for direct access from the Annendale Road. Access will have to be gained over private property as well as a river crossing.	
<u>Area size</u>	Even though Area A consists of a large enough area to accommodate a regional cemetery it has to allow for the possible future construction of a western by-pass. Planning for such a possibility will somewhat fragmented a proposed site.	
<u>Biophysical</u>	High yielding boreholes directly south of the site.	
<u>Land Use</u>		The area is currently being used for agricultural purposes. The development of this area will result in the sterilization of the particular area from agriculture. In addition, there is one lease agreement that will be affected by the establishment of a cemetery on the site.
<i>Notes:</i>	The lease agreement in place with the lessee on the relevant portion of land allows the Municipality to end the agreement with 12-month notice.	

Whilst Area B is less complicated than Area A with regards to possible future development (possible extension of the airfield / development of a western by-pass) the biggest difference between the two areas is its location in terms of its proximity to the Annendale Road. To provide access to Area A will require access over private land as well as make provision for a river crossing. Area B is located on the Annendale Road. The development of access to Area B will represent a substantial saving (in the order of R1.2mil) to Council compared to the development of access to Area A.

## 2.2 MEERLUST

Portion 1 of Farm Meer Lust No 1006 is located in the Dwarsriver Valley north of Pniel and the Helshoogte Road / R45 intersection (Figure 3). This property is located in the "Eastern District" of the municipal area, located in relatively close proximity of Klapmuts, Pniel and Wemmershoek.

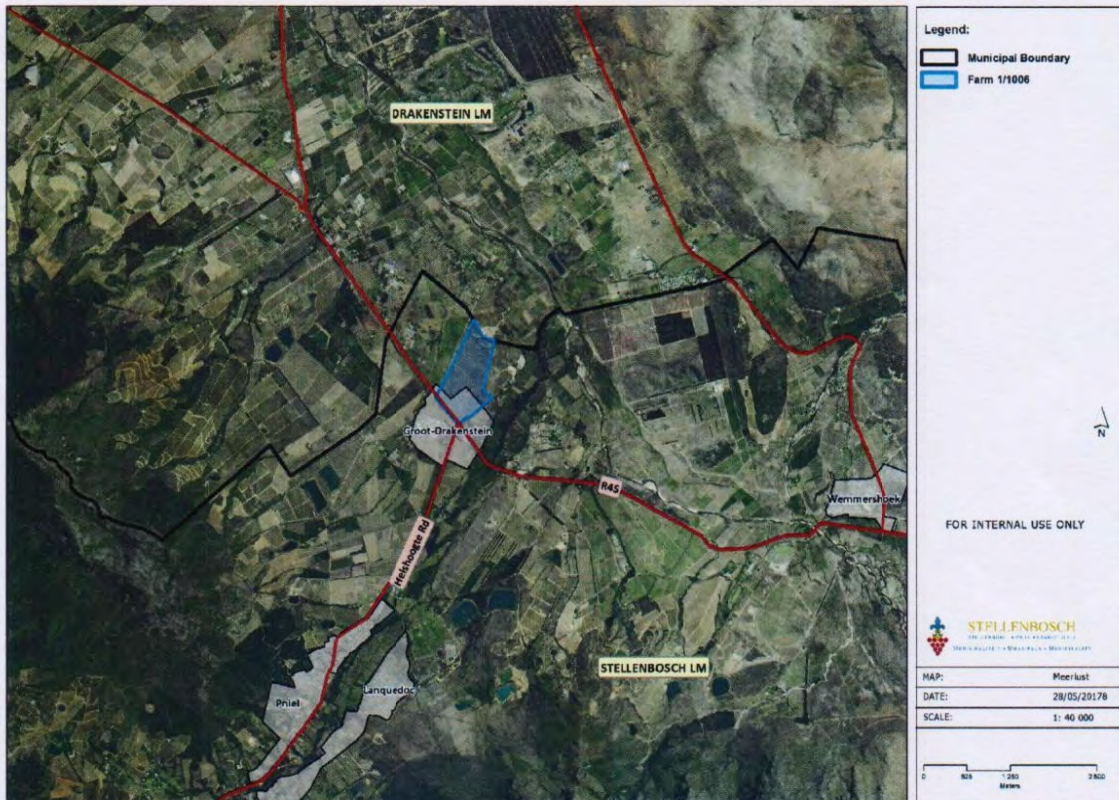

Figure 3: Portion 1 of Farm Meer Lust No 1006

Of the three sites Portion 1 of Farm Meer Lust No 1006 received the most input from the public during the above public participation process. Most of these responses where,

however, relating to the local community's demand for housing and the need for economic development rather than that of burial space.

The main concerns that were identified during the above public participation process was the following:

- Access will need to be provided
- Possible congestion on the R301
- Social – Housing requirements/title deed (tenure outstanding)
- Need for economic development
- Conservation of natural vegetation
- Potential groundwater contamination

### 2.2.1 Site Advantages

<u>Location</u>	Ideally located to serve the northern and eastern district of Stellenbosch Municipality.
<u>Access</u>	Directly off the R45.
<u>Area size</u>	±20ha. Large enough to accommodate a regional cemetery site.

### 2.2.2 Site Challenges

<u>Location</u>	Located in close proximity to existing residential settlement. It is also located close to high yielding boreholes.
-----------------	---

Portion 1 of Farm Meer Lust No 1006 is ideally located in the Eastern District of the municipal area in relatively close proximity to various local settlements. However, the site's location in terms of its proximity to an existing settlement and boreholes represents a risk if the legislation guiding the location of cemeteries and the requirements for buffer zones from these areas is rigorously applied. The National Health Act, 61 of 2003, Regulations Relating to the Management of Human Remains (Government Notice R363), includes the following:

#### 15. *Burial sites and burials*

- (2) *All burial sites must comply with the following environmental requirements-*
- (a) *be located outside the 100 year floodplain;*
  - (b) ***be located at least 350m from ground water sources used for drinking purposes and 500m from the nearest habitable building;***
  - (c) *...*

Even though there are examples of cemetery sites that have been established within these zones since the above regulations came into effect proceeding with an application for

establishing a cemetery site within these zones is a risk if the relevant authorities can not be convinced of the need and impact of such development.

### 2.3 CULCATA

Stellenbosch Municipality owns Farm Culcatta No. 29. Farm Culcatta No. 29 borders the R304 to the east between the Koelenhof node and Muldervlei Crossing (Figure 4). This property is located in the "North Western District" of the municipal area, is lying fallow and is currently overgrown with alien vegetation *Eucalyptus globulus* or Tasmanian blue gum. This property is surrounded by privately owned agricultural land. Limited response was received during the above public participation process.

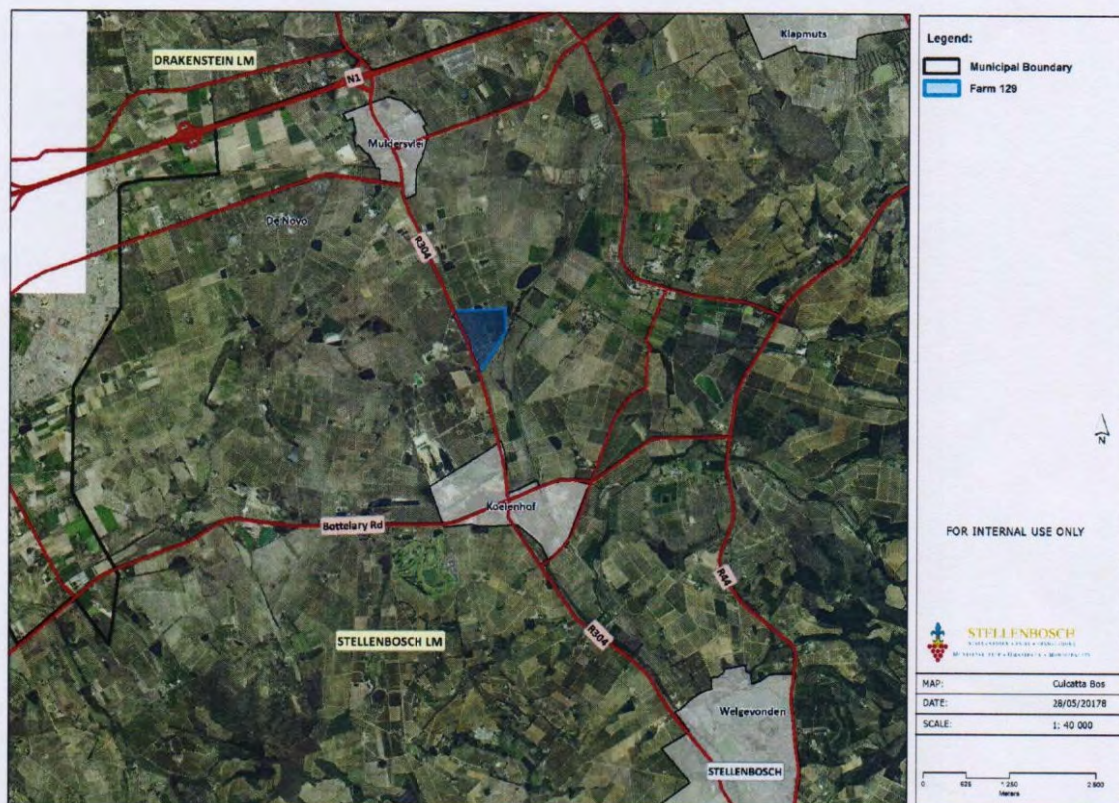

Figure 4: Farm Culcatta No 29

The main concerns that were identified during the above public participation process was the following:

- Access will need to be provided
- Potential ground water/surface water contamination
- Congestion of the R304 as a high-speed road
- Aesthetics impact

### 2.3.1 Site Advantages

<u>Access</u>	Directly off the R304 onto municipal land.
<u>Area size</u>	±26ha. Large enough to accommodate a regional cemetery site.
<u>Biophysical</u>	Biophysically the site is suitable for cemetery establishment. Soil-type is Malmesbury Group shales.
<u>Land Use</u>	The property is underutilized and lying fallow.

### 2.3.2 Site Challenges

<u>Access</u>	Requirement to be set by provincial Department of Transport. This can be time-consuming and expensive.
<u>Location</u>	Not as ideally located compared to the other two sites, somewhat removed from the main settlements of Stellenbosch Municipality.

## **3. RECOMMENDATIONS**

The appointment of CK Rumboll & Partners for BID 17/16 was for the identification of cemetery sites (regional, ±30ha in size), followed with the acquisition of the required authorization for cemetery establishment (for two sites), the planning and design of all related infrastructure for such cemeteries, the planning and design of the cemeteries itself as well as the establishment of cemetery registers for the respective cemeteries.

Based on the information gathered during the project so far it is recommended that the above process continue for the following two (2) sites:

#### Farm Louw's Bos No. 502 (Area B)

Reasons:

- Located in close proximity to where the largest portion of population of Stellenbosch Municipality resides.
- Access directly off the Annendale Road (Area B) onto municipal land.
- Largest of the four sites (Area B: ±35ha) that formed part of the above Council Resolution.

#### Farm Culcatta No. 29

Reasons:

- The development of underutilized municipal land.

- Access directly off the R304 onto municipal land, however, the cost implications to access from a high speed road may be onerous as additional slip lanes will be required.

Portion 1 of Farm Meer Lust No 1006 provides a more central location for the establishment of a regional cemetery site than Farm Culcatta No. 29. The reason for the exclusion of Portion 1 of Farm Meer Lust No. 1006 is the site's proximity to an existing settlement and a borehole. The risk to Council for pursuing the establishment of a regional cemetery site on Portion 1 of Farm Meer Lust No. 1006 is that the full processes of acquiring environmental and other authorization can be run, and associated expenses incurred, only to be refused the right by the National Department of Health or the Department of Water and Sanitation to establish such use at a later stage. If the prescribed buffers included in the relevant legislation described above are applied on the site (excluded from the total area that comprises the identified site) the remaining total area does not allow for the establishment of a regional cemetery site. Council may in the future, rather consider the establishment of a local cemetery that allows for the recommended buffers from the existing settlement and borehole at the same site.

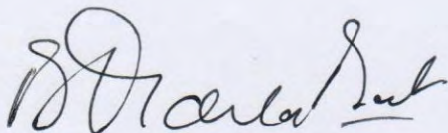

**B DE LA BAT**  
**MANAGER: SPATIAL PLANNING, HERITAGE & ENVIRONMENT**

Approved / ~~Not approved~~

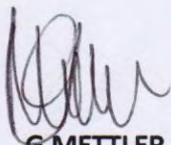

**G METTLER**  
**MUNICIPAL MANAGER**  
**STELLENBOSCH MUNICIPALITY**

# **APPENDIX 4**

REFERENCE: 16/3/3/1/B4/45/1047/19  
DATE: 19 AUGUST 2020

The Municipal Manager  
Stellenbosch Municipality  
P. O. Box 17  
STELLENBOSCH  
7599

Attention: Mr. P. Smit

Tel.: (021) 808 8750  
Email: Piet.Smit@stellenbosch.gov.za

Dear Sir

CORRECTION NOTICE: THE PROPOSED **LOUW'S BOS PUBLIC CEMETERY AND MEMORIAL PARK ON FARM NO. 502, STELLENBOSCH**

1. The Environmental Authorisation ("EA") issued by the Department on 22 January 2020 and the subsequent electronic correspondence from Ms. V. Thompson on 11 August 2020, refer.
2. With reference to the above, the Department herewith acknowledges the typographical error in Section B in the EA, as outlined in the electronic correspondence.
3. In order to rectify the matter, kindly note that in terms of Section 47A(1)(b) of the National Environmental Management Act, 1998 (Act no. 107 of 1998, as amended) the administrative error in the EA is corrected as follows:

### 3.1 SECTION B: LIST OF ACTIVITIES AUTHORISED

Listed activities	Activity/Project Description
EIA Regulations Listing Notice 1 of 2014: Activity Number 23: The development of cemeteries of 2 500 square metres or more in size.	The proposed public cemetery and memorial park will cover an area of approximately 30ha in extent.

Is replaced with:

Listed activities	Activity/Project Description
EIA Regulations Listing Notice 1 of 2014: Activity Number 23: The development of cemeteries of 2 500 square metres or more in size.	The proposed public cemetery and memorial park will cover an area of approximately 74ha in extent.



4. Reasons for rectifying the error:

4.1 The error is administrative in nature as the activity remains the same as that which was assessed and described in the documents supporting the application for authorisation.

4.1 The environment and the rights and interests of other parties are not likely to be adversely affected by this decision to rectify the administrative error as the impacts associated with the activity were assessed during the EIA process.

5. You are requested to bring the contents of this letter to the attention of all registered Interested and Affected Parties ("I&APs") and submit the proof thereof to this Department.

5.1 If an I&AP wishes to lodge an appeal as a consequence of this correction notice, the I&AP must apply to the Minister (Mr. Anton Bredell) for condonation to submit a late appeal. Condonation requests must be submitted for to:

Attention: Mr Marius Venter

Tel: (021) 483 3721;

Fax: (021) 483 4174); or

Email: [DEADP.Appeals@westerncape.gov.za](mailto:DEADP.Appeals@westerncape.gov.za)

Yours faithfully



MR. ZAAHIR TOEFY

DIRECTOR: DEVELOPMENT MANAGEMENT (REGION 1)

DEPARTMENT OF ENVIRONMENTAL AFFAIRS AND DEVELOPMENT PLANNING

Cc: (1) Mr. S. van der Merwe (Stellenbosch Municipality)

Email: [schalk.vandermerwe@stellenbosch.gov.za](mailto:schalk.vandermerwe@stellenbosch.gov.za)

(2) Ms. V. Thompson (EnviroAfrica CC)

Email: [vivienne@enviroafrica.co.za](mailto:vivienne@enviroafrica.co.za)

(3) Mr. N. Mkonto (Department of Water and Sanitation)

Email: [mkonton@dws.gov.za](mailto:mkonton@dws.gov.za)

(4) Mr. R. Smart (CapeNature)

Email: [rsmart@capenature.co.za](mailto:rsmart@capenature.co.za)

(5) Mr. C. van der Walt (Department of Agriculture)

Email: [corvdw@elsenburg.com](mailto:corvdw@elsenburg.com)

(6) Mr. M. Venter (DEA&DP)

Email: [Marius.Venter@westerncape.gov.za](mailto:Marius.Venter@westerncape.gov.za)

# **APPENDIX 5**



**Western Cape  
Government**

Environmental Affairs and  
Development Planning

Directorate: Development Management  
(Region 1)

**EIA REFERENCE:** 16/3/3/1/B4/45/1030/19  
**NEAS REFERENCE:** WCP/EIA/0000593/2019  
**ENQUIRIES:** D'mitri Matthews  
**DATE OF ISSUE:** 2019 -09- 2 0

The Municipal Manager  
Stellenbosch Municipality  
P. O. Box 17  
**STELLENBOSCH**  
7599

**Attention: Mr P. Smit**

Tel.: (021) 808 8750

Fax: (021) 887 6167

Dear Sir

**APPLICATION FOR ENVIRONMENTAL AUTHORISATION AND THE ADOPTION OF A FRESHWATER REHABILITATION, MAINTENANCE AND MANAGEMENT PLAN IN TERMS OF THE NATIONAL ENVIRONMENTAL MANAGEMENT ACT, 1998 (ACT 107 OF 1998) AND THE ENVIRONMENTAL IMPACT ASSESSMENT REGULATIONS, 2014, (AS AMENDED): DEVELOPMENT OF THE CALCUTTA PUBLIC CEMETERY AND MEMORIAL PARK ON FARM NO. 29, STELLENBOSCH**

1. With reference to the above application, the Department hereby notifies you of its decision to **grant** Environmental Authorisation and to **adopt** the Freshwater Rehabilitation, Maintenance and Management Plan, attached herewith, together with the reasons for the decision.
2. In terms of Regulation 4 of the Environmental Impact Assessment Regulations, 2014, (as amended), you are instructed to ensure, within 14 days of the date of the Environmental Authorisation, that all registered Interested and Affected Parties ("I&APs") are provided with access to and reasons for the decision, and that all registered I&APs are notified of their right to appeal.
3. Your attention is drawn to Chapter 2 of the National Appeal Regulations, 2014 (as amended), which prescribes the appeal procedure to be followed. This procedure is summarized in the attached Environmental Authorisation.

Yours faithfully

  
**MR. ZA'AHIR JOFY**

**DIRECTOR: DEVELOPMENT MANAGEMENT (REGION 1)  
DEPARTMENT OF ENVIRONMENTAL AFFAIRS AND DEVELOPMENT PLANNING**

CC: (1) Mr. S. van der Merwe (Stellenbosch Municipality)  
(2) Ms. V. Thompson (EnviroAfrica CC)  
(3) Mr. N. Mkonto (Department of Water and Sanitation)  
(4) Mr. R. Smart (CapeNature)  
(5) Mr. C. van der Walt (Department of Agriculture)

Fax: (021) 886 6899  
Fax: (086) 512 0154  
Fax: (021) 941 6082  
Fax: (086) 529 4992  
Fax: (021) 808 5092



**Western Cape  
Government**

Environmental Affairs and  
Development Planning

Directorate: Development Management  
(Region 1)

**EIA REFERENCE:** 16/3/3/1/B4/45/1030/19  
**NEAS REFERENCE:** WCP/EIA/0000593/2019  
**ENQUIRIES:** D'mitri Matthews  
**DATE OF ISSUE:** 2019 -09- 2 0

## ENVIRONMENTAL AUTHORISATION

### APPLICATION FOR ENVIRONMENTAL AUTHORISATION AND THE ADOPTION OF A FRESHWATER REHABILITATION, MAINTENANCE AND MANAGEMENT PLAN IN TERMS OF THE NATIONAL ENVIRONMENTAL MANAGEMENT ACT, 1998 (ACT 107 OF 1998) AND THE ENVIRONMENTAL IMPACT ASSESSMENT REGULATIONS, 2014, (AS AMENDED): DEVELOPMENT OF THE CALCUTTA PUBLIC CEMETERY AND MEMORIAL PARK ON FARM NO. 29, STELLENBOSCH

With reference to your application for the abovementioned, find below the outcome with respect to this application.

## DECISION

By virtue of the powers conferred on it by the National Environmental Management Act, 1998 (Act No. 107 of 1998) ("NEMA") and the Environmental Impact Assessment ("EIA") Regulations, 2014 (as amended), the Competent Authority herewith **grants Environmental Authorisation** to the applicant to undertake the listed activities specified in Section B below with respect to Alternative 1, described in the Basic Assessment Report ("BAR"), dated May 2019.

In terms of the NEMA, viz, the EIA Regulations, 2014 (as amended) (in Government Gazette No. 40772 of 7 April 2017) the Competent Authority hereby **adopts the Freshwater Rehabilitation, Maintenance and Management Plan ("FRMMP")** for the associated infrastructure within and adjacent to the watercourse on site, included in the BAR dated May 2019.

The applicant for this Environmental Authorisation is required to comply with the conditions set out in Section E below.

## A. DETAILS OF THE APPLICANT FOR THIS ENVIRONMENTAL AUTHORISATION

Stellenbosch Municipality  
 % Mr. P. Smit  
 P. O. Box 17  
**STELLENBOSCH**  
 7599

6<sup>th</sup> Floor, 1 Dorp Street, Cape Town, 8001  
 Tel: +27 21 483 8350 Fax: +27 21 483 3098  
 E-mail: D'mitri.Matthews@westerncape.gov.za

Private Bag X9086, Cape Town, 8000  
[www.westerncape.gov.za/eadp](http://www.westerncape.gov.za/eadp)

Tel.: (021) 808 8750

Fax: (021) 887 6167

The abovementioned applicant is the holder of this Environmental Authorisation and is hereinafter referred to as "**the holder**".

## B. LIST OF ACTIVITIES AUTHORISED

Listed activities	Activity/Project Description
<p>EIA Regulations Listing Notice 1 of 2014: Activity Number 12: The development of—</p> <p>(i) dams or weirs, where the dam or weir, including infrastructure and water surface area, exceeds 100 square metres; or</p> <p><b>(ii) infrastructure or structures with a physical footprint of 100 square metres or more;</b></p> <p>where such development occurs—</p> <p>(a) within a watercourse;</p> <p>(b) in front of a development setback; or</p> <p>(c) if no development setback exists, within 32 metres of a watercourse, measured from the edge of a watercourse; —</p> <p>excluding—</p> <p>(aa) the development of infrastructure or structures within existing ports or harbours that will not increase the development footprint of the port or harbour;</p> <p>(bb) where such development activities are related to the development of a port or harbour, in which case activity 26 in Listing Notice 2 of 2014 applies;</p> <p>(cc) activities listed in activity 14 in Listing Notice 2 of 2014 or activity 14 in Listing Notice 3 of 2014, in which case that activity applies;</p> <p>(dd) where such development occurs within an urban area;</p> <p>(ee) where such development occurs within existing roads, road reserves or railway line reserves; or</p> <p>(ff) the development of temporary infrastructure or structures where such infrastructure or structures will be removed within 6 weeks of the commencement of development and where indigenous vegetation will not be cleared.</p>	<p>The proposal will include the construction of boardwalks and wooden bridges as well as a gabion lined drift, over the watercourse that traverses the site.</p>
<p>Activity Number 19: The infilling or depositing of any material of more than 10 cubic metres into, or the dredging, excavation, removal or moving of soil, sand, shells,</p>	<p>The construction and maintenance of the watercourse crossings and the rehabilitation of the watercourse will require the infilling and movement of material in excess of 10m<sup>3</sup>.</p>

<p>shell grit, pebbles or rock of more than 10 cubic metres from a watercourse;</p> <p>but excluding where such infilling, depositing, dredging, excavation, removal or moving—</p> <p>(a) will occur behind a development setback;</p> <p>(b) is for maintenance purposes undertaken in accordance with a maintenance management plan;</p> <p>(c) falls within the ambit of activity 21 in this Notice, in which case that activity applies;</p> <p>(d) occurs within existing ports or harbours that will not increase the development footprint of the port or harbour; or</p> <p>(e) where such development is related to the development of a port or harbour, in which case activity 26 in Listing Notice 2 of 2014 applies.</p>	
<p>Activity Number 23: The development of cemeteries of 2 500 square metres or more in size.</p>	<p>The proposed public cemetery and memorial park will cover an area of approximately 30ha in extent.</p>
<p>Activity Number 24: The development of a road—</p> <p>(i) for which an environmental authorisation was obtained for the route determination in terms of activity 5 in Government Notice 387 of 2006 or activity 18 in Government Notice 545 of 2010; or</p> <p><b>(ii) with a reserve wider than 13,5 meters, or where no reserve exists where the road is wider than 8 metres;</b></p> <p>but excluding a road—</p> <p>(a) which [are] is identified and included in activity 27 in Listing Notice 2 of 2014;</p> <p>(b) where the entire road falls within an urban area; or</p> <p>(c) which is 1 kilometre or shorter.</p>	<p>An access road wider than 8m will be constructed as part of the proposal, in an area where no road reserve exists.</p>
<p>EIA Regulations Listing Notice 1 of 2014: Activity Number 4: The development of a road wider than 4 metres with a reserve less than 13,5 metres.</p> <p><b>i. Western Cape</b></p> <p>i. Areas zoned for use as public open space or equivalent zoning;</p> <p>ii. Areas outside urban areas;</p> <p><b>(aa) Areas containing indigenous vegetation;</b></p> <p>(bb) Areas on the estuary side of the development setback line or in an estuarine functional zone where no such setback line has been</p>	<p>The new access road will be wider than 4m and will require the removal of indigenous vegetation.</p>

<p>determined; or</p> <p>iii. Inside urban areas:</p> <p>(aa) Areas zoned for conservation use; or</p> <p>(bb) Areas designated for conservation use in Spatial Development Frameworks adopted by the competent authority.</p>	
<p>Activity Number 12:</p> <p>The clearance of an area of 1 hectares or more, but less than 20 hectares of indigenous vegetation, except where such clearance of indigenous vegetation is required for—</p> <p>(i) the undertaking of a linear activity; or</p> <p>(ii) maintenance purposes undertaken in accordance with a maintenance management plan.</p> <p><b>i. Western Cape</b></p> <p><b>i. Within any critically endangered or endangered ecosystem listed in terms of section 52 of the NEMBA or prior to the publication of such a list, within an area that has been identified as critically endangered in the National Spatial Biodiversity Assessment 2004;</b></p> <p>ii. Within critical biodiversity areas identified in bioregional plans;</p> <p>iii. Within the littoral active zone or 100 metres inland from high water mark of the sea or an estuarine functional zone, whichever distance is the greater, excluding where such removal will occur behind the development setback line or even in urban areas;</p> <p>iv. On land, where, at the time of the coming into effect of this Notice or thereafter such land was zoned open space, conservation or had an equivalent zoning; or</p> <p>v. On land designated for protection or conservation purposes in an Environmental Management Framework adopted in the prescribed manner, or a Spatial Development Framework adopted by the MEC or Minister.</p>	<p>The proposal will include the clearance of more than 300m<sup>2</sup> of critically endangered indigenous vegetation.</p>

The abovementioned list is hereinafter referred to as "**the listed activities**".

The holder is herein authorised to undertake the following alternative:

The proposal entails the development of a public cemetery and memorial park that will comprise:

- A traditional grave area which allows for whole-body burials in traditional underground graves with headstones.
- An informal zone. This zone is non-traditional burial sites within a memorial park/landscaped park/garden area with lawn plaques/or a tree of remembrance/tree as

headstone. The zone will incorporate the outspan in the southern section of the site and wetland buffer zones of 25m to 30m for watercourses.

- A columbarium and defined zone. These zones are non-traditional burial sites that comprise of formalized/built, above ground areas where either individual or group burials will take place. These areas include structures with niche/small spaces for placing cremated/legally reduced remains in urns or other approved containers, memorial walls with plaques of remembrance, floor plaques/flat headstones and mausoleums or crypts.
- A defined zone that includes an area for family and group burials and a heroes acre.
- An access road that will be constructed at a dedicated two-way intersection of the R304 at approximate KM 50,37.
- Internal roads of 8m wide near the entrance and around the bus parking and narrower roads for access to other regions within the cemetery and memorial park.
- A perimeter fence with main access gates and an entrance wall on the northern boundary.
- Boardwalks and wooden bridges.
- Gabion lined drift.
- An irrigation reservoir.
- A memorial park center and service zone consisting of:
  - A chapel,
  - Offices and a storage area,
  - Ablution facilities,
  - A workshop,
  - A plant/sapling nursery,
  - Staff accommodation, and
  - A gathering space.
- A sewer treatment plant and network.
- A storm water network and treatment plant. The subsurface storm water network will discharge storm water into a reed bed/storm water treatment system. A storm water attenuation pond will form part of the storm water management system.
- A security route along the boundary of the site.

### C. SITE DESCRIPTION AND LOCATION

The listed activities will be undertaken on Farm No. 29, Stellenbosch, at the following co-ordinates:

Latitude (S)			Longitude (E)		
33°	51'	13.55"	18°	48'	35.96"

The SG digit code is: C06700000000002900000

Refer to Annexure 1: Locality Map and Annexure 2: Site Development Plan.

The above is hereinafter referred to as "the site".

### D. DETAILS OF THE ENVIRONMENTAL ASSESSMENT PRACTITIONER

EnviroAfrica CC  
% Ms. V. Thomson  
P. O. Box 5367



**HELDERBERG**

7135

Tel.: (021) 851 1616

Fax: (086) 512 0154

**E. CONDITIONS OF AUTHORISATION****Scope of authorisation**

1. The holder is authorised to undertake the listed activities specified in Section B above in accordance with, and restricted to, Alternative 1, as described in the BAR dated May 2019 at the site as described in Section C above.
2. The holder must commence with the listed activities on site within a period of **five (5) years** from the date of issue of this Environmental Authorisation.
3. The development must be concluded within **10 years** from the date of commencement of the first listed activity.
4. The holder shall be responsible for ensuring compliance with the conditions by any person acting on his/her behalf, including an agent, sub-contractor, employee or any person rendering a service to the holder.
5. Any changes to, or deviations from the scope of the alternative described in Section B above must be accepted or approved, in writing, by the Competent Authority before such changes or deviations may be implemented. In assessing whether to grant such acceptance/approval or not, the Competent Authority may request information, in order to evaluate the significance and impacts of such changes or deviations, and it may be necessary for the holder to apply for further authorisation in terms of the applicable legislation.

**Written notice to the Competent Authority**

6. Seven calendar days' notice, in writing, must be given to the Competent Authority before commencement of construction activities. The notice must:
  - 6.1 make clear reference to the site details and EIA Reference number given above; and
  - 6.2 include proof of compliance with the following conditions described herein:

Conditions: 7, 8 and 12

**Notification and administration of appeal**

7. The holder must in writing, within 14 (fourteen) calendar days of the date of this decision–
  - 7.1 notify all registered Interested and Affected Parties ("I&APs") of –
    - 7.1.1 the outcome of the application;
    - 7.1.2 the reasons for the decision as included in Annexure 3;
    - 7.1.3 the date of the decision; and

- 7.1.4 the date when the decision was issued.
- 7.2 draw the attention of all registered I&APs to the fact that an appeal may be lodged against the decision in terms of the National Appeals Regulations, 2014 (as amended) detailed in Section G below;
- 7.3 draw the attention of all registered I&APs to the manner in which they may access the decision; and
- 7.4 provide the registered I&APs with:
- 7.4.1 the name of the holder (entity) of this Environmental Authorisation;
  - 7.4.2 name of the responsible person for this Environmental Authorisation;
  - 7.4.3 postal address of the holder;
  - 7.4.4 telephonic and fax details of the holder;
  - 7.4.5 e-mail address, if any, of the holder; and
  - 7.4.6 contact details (postal and/or physical address, contact number, facsimile and e-mail address) of the decision-maker and all registered I&APs in the event that an appeal is lodged in terms of the 2014 National Appeals Regulations (as amended).
8. The listed activities, including site preparation, must not commence within 20 (twenty) calendar days from the date the applicant notifies the registered I&APs of this decision. In the event that an appeal is lodged with the Appeal Authority, the effect of this Environmental Authorisation is suspended until the appeal is decided i.e. the listed activities, including site preparation, must not commence until the appeal is decided.

#### **Management of activity**

9. The draft Environmental Management Programme ("EMPr") submitted as part of the application for Environmental Authorisation is hereby approved and must be implemented.
10. The Freshwater Rehabilitation, Maintenance and Management Plan ("FRMMP") adopted as part of this Environmental Authorisation must be implemented.
11. The EMPr and FRMMP must be included in all contract documentation for all phases of implementation.

#### **Monitoring**

12. The holder must appoint a suitably experienced environmental control officer ("ECO"), or site agent where appropriate, before commencement of any land clearing or construction activities to ensure compliance with the EMPr, FRMMP and the conditions contained herein.
13. A copy of the Environmental Authorisation, EMPr, FRMMP, audit reports and compliance monitoring reports must be kept at the site of the authorised activity, and must be made available to anyone on request, including on a publicly accessible website.
14. Access to the site referred to in Section C must be granted, and the environmental reports mentioned above must be produced, to any authorised official representing the Competent Authority who requests to see it for the purposes of assessing and/or monitoring compliance with the conditions contained herein.

**Auditing**

15. In terms of Regulation 34 of the NEMA EIA Regulations, 2014 (as amended), the holder must conduct environmental audits to determine compliance with the conditions of the Environmental Authorisation, the EMPr and submit Environmental Audit Reports to the Competent Authority. The Environmental Audit Report must be prepared by an independent person and must contain all the information required in Appendix 7 of the NEMA EIA Regulations, 2014 (as amended).

The ECO must conduct fortnightly site audits. Monthly ECO Audit Reports must be submitted to the Competent Authority for the duration of the construction phase. The final Environmental Audit Report must be submitted to the Competent Authority six months after operation commenced.

The holder must, within 7 days of the submission of each of the above-mentioned reports to the Competent Authority, notify all potential and registered I&APs of the submission and make the report available to anyone on request and on a publicly accessible website (if applicable).

**Specific Conditions**

16. Should any heritage remains be exposed during excavations or any other actions on the site, these must immediately be reported to the Provincial Heritage Resources Authority of the Western Cape, Heritage Western Cape. Heritage remains uncovered or disturbed during earthworks must not be further disturbed until the necessary approval has been obtained from Heritage Western Cape.

Heritage remains include: meteorites, archaeological and/or paleontological remains (including fossil shells and trace fossils); coins; indigenous and/or colonial ceramics; any articles of value or antiquity; marine shell heaps; stone artefacts and bone remains; structures and other built features with heritage significance; rock art and rock engravings; and/or graves or unmarked human burials including grave goods and/or associated burial material.

17. A qualified archaeologist and/or palaeontologist must be contracted where necessary (at the expense of the holder) to remove any heritage remains. Heritage remains can only be disturbed by a suitably qualified heritage specialist working under a directive from the relevant heritage resources authority.

**F. GENERAL MATTERS**

1. Notwithstanding this Environmental Authorisation, the holder must comply with any other statutory requirements that may be applicable when undertaking the listed activities.
2. Non-compliance with a condition of this Environmental Authorisation or EMPr may render the holder liable to criminal prosecution.
3. If the holder does not commence with the listed activities within the period referred to in Condition 2, this Environmental Authorisation shall lapse for that activity, and a new application for Environmental Authorisation must be submitted to the Competent Authority. If the holder wishes to extend the validity period of the Environmental Authorisation, an

application for amendment in this regard must be made to the Competent Authority prior to the expiry date of the Environmental Authorisation.

4. The holder must submit an application for amendment of the Environmental Authorisation to the Competent Authority where any detail with respect to the Environmental Authorisation must be amended, added, substituted, corrected, removed or updated. If a new holder is proposed, an application for Amendment in terms of Part 1 of the EIA Regulations, 2014 (as amended) must be submitted.

Please note that an amendment is not required if there is a change in the contact details of the holder. In this case, the Competent Authority must only be notified of such changes.

5. The manner and frequency for updating the EMPr is as follows:  
Amendments to the EMPr must be done in accordance with Regulations 35 to 37 of the EIA Regulations, 2014 (as amended) or any relevant legislation that may be applicable at the time.

## **G. APPEALS**

Appeals must comply with the provisions contained in the National Appeal Regulations 2014 (as amended).

1. An appellant (if the holder of the decision) must, within 20 (twenty) calendar days from the date on which notification of the decision was sent to the holder by the Competent Authority –
  - 1.1. submit an appeal in accordance with Regulation 4 of the National Appeal Regulations 2014 (as amended) to the Appeal Administrator; and
  - 1.2. submit a copy of the appeal to any registered I&APs, any Organ of State with interest in the matter and the decision-maker i.e. the Competent Authority that issued the decision.
2. An appellant (if NOT the holder of the decision) must, within 20 (twenty) calendar days from the date on which the holder of the decision sent notification of the decision to the registered I&APs–
  - 2.1. submit an appeal in accordance with Regulation 4 of the National Appeal Regulations 2014 (as amended) to the Appeal Administrator; and
  - 2.2. submit a copy of the appeal to the holder of the decision, any registered I&AP, any Organs of State with interest in the matter and the decision-maker i.e. the Competent Authority that issued the decision.
3. The holder of the decision (if not the appellant), the decision-maker that issued the decision, the registered I&AP and the Organs of State must submit their responding statements, if any, to the appeal authority and the appellant within 20 (twenty) calendar days from the date of receipt of the appeal submission.
4. The appeal and the responding statement must be submitted to the address listed below:

By post: Western Cape Ministry of Local Government, Environmental Affairs and  
Development Planning  
Private Bag X9186  
CAPE TOWN  
8000

By facsimile: (021) 483 4174; or

By hand: Attention: Mr Marius Venter (Tel: 021 483 2659)  
Room 809  
8<sup>th</sup> Floor Utilitas Building, 1 Dorp Street, Cape Town, 8001

**Note:** For purposes of electronic database management, you are also requested to submit electronic copies (Microsoft Word format) of the appeal, responding statement and any supporting documents to the Appeal Authority to the address listed above and/ or via e-mail to DEADP.Appeals@westerncape.gov.za

5. A prescribed appeal form as well as assistance regarding the appeal processes is obtainable from Appeal Authority at: Tel. (021) 483 2659, E-mail DEADP.Appeals@westerncape.gov.za or URL <http://www.westerncape.gov.za/eadp>.

#### H. DISCLAIMER

The Western Cape Government, the Local Authority, committees or any other public authority or organisation appointed in terms of the conditions of this Environmental Authorisation shall not be responsible for any damages or losses suffered by the holder, developer or his/her successor in any instance where construction or operation subsequent to construction is temporarily or permanently stopped for reasons of non-compliance with the conditions as set out herein or any other subsequent document or legal action emanating from this decision.

Your interest in the future of our environment is appreciated.

Yours faithfully



MR. ZAHIR TOEFY

**DIRECTOR: DEVELOPMENT MANAGEMENT (REGION 1)**

**DEPARTMENT OF ENVIRONMENTAL AFFAIRS AND DEVELOPMENT PLANNING**

DATE OF DECISION: 20/09/2019

CC: (1) Mr. S. van der Merwe (Stellenbosch Municipality)  
(2) Ms. V. Thompson (EnviroAfrica CC)  
(3) Mr. N. Mkonto (Department of Water and Sanitation)  
(4) Mr. R. Smart (CapeNature)  
(5) Mr. C. van der Walt (Department of Agriculture)

Fax: (021) 886 6899  
Fax: (086) 512 0154  
Fax: (021) 941 6082  
Fax: (086) 529 4992  
Fax: (021) 808 5092

**ANNEXURE 1: LOCALITY MAP**



Figure 1: Locality map.

ANNEXURE 2: SITE DEVELOPMENT PLAN

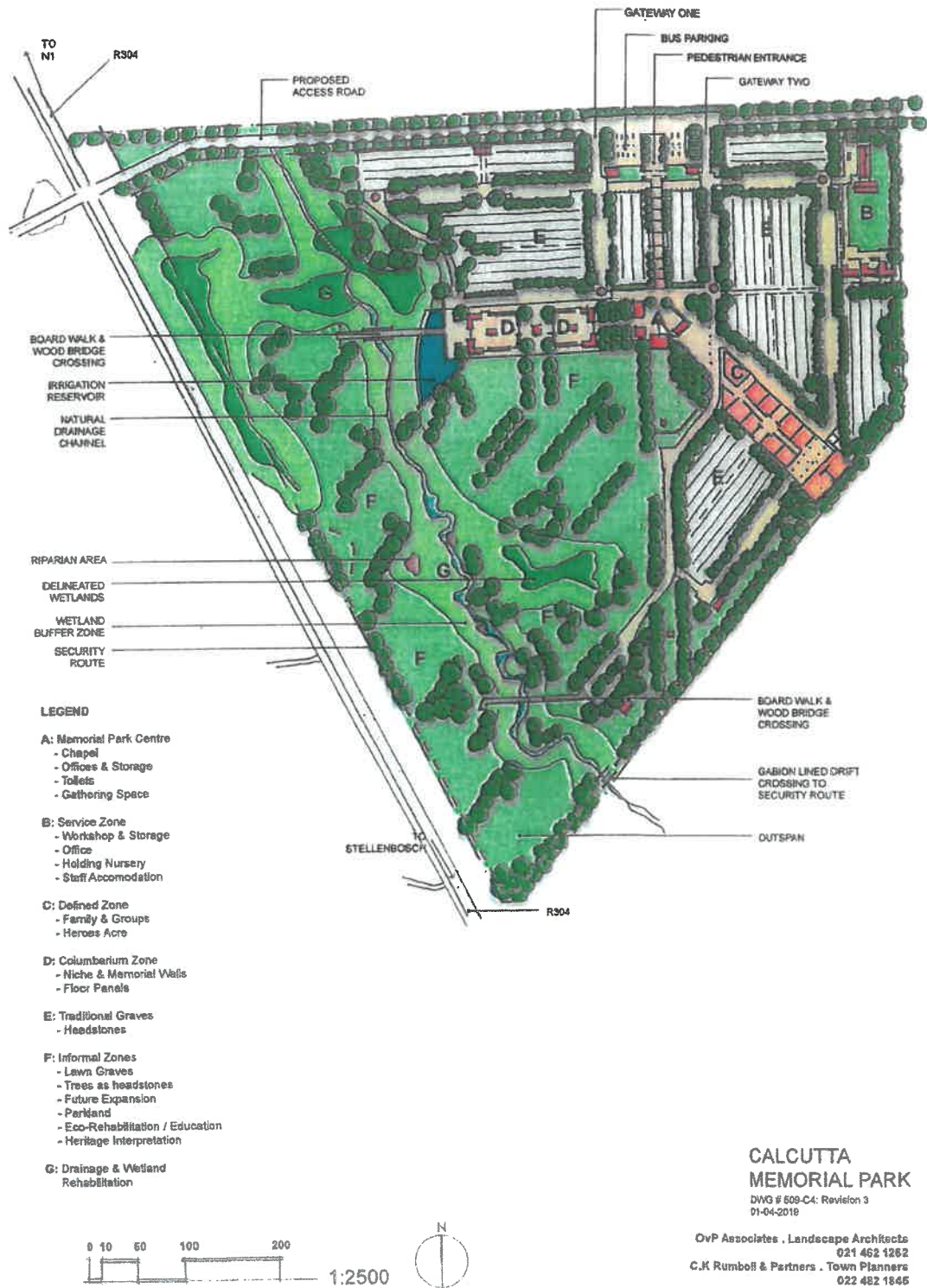

Figure 2: Site development plan for the cemetery and memorial park.



Figure 3: Storm water and sewage plan layout.



**ANNEXURE 3: REASONS FOR THE DECISION**

In reaching its decision, the Competent Authority considered, amongst others, the following:

- a) The information contained in the Application Form dated 16 April 2019, the final BAR dated May 2019 and the EMPr and FRMMP submitted together with the final BAR;
- b) Relevant information contained in the Departmental information base, including the Guidelines on Public Participation and Alternatives (dated March 2013);
- c) The objectives and requirements of relevant legislation, policies and guidelines, including Section 2 of NEMA;
- d) The comments received from I&APs and responses to these, included in the BAR dated May 2019; and
- e) The balancing of negative and positive impacts and proposed mitigation measures.

No site visits were conducted. The Competent Authority had sufficient information before it to make an informed decision without conducting a site visit.

All the concerns raised by I&APs were responded to and addressed during the public participation process. Specific management and mitigation measures have been considered in this Environmental Authorisation EMPr and in the FRMMP, in order to address the concerns raised.

**1. Public Participation**

The public participation process included:

- identification of and engagement with I&APs;
- fixing notice boards at the sites where the listed activities are to be undertaken on 7 February 2018;
- the placing of a newspaper advertisement in the 'Eikestad Nuus' on 8 February 2018;
- giving written notice to the owners and occupiers of land adjacent to the site where the listed activities are to be undertaken, the municipality and ward councillor, and the various Organs of State having jurisdiction in respect of any aspect of the listed activities, on 14 September 2017, 9 February 2018, 15 November 2018, 1 February 2019 and 23 April 2019; and
- making the pre-application draft BAR's available to I&APs from 15 November 2018 and 1 February 2019 and making the in-process draft BAR available to I&APs for public review from 23 April 2019.

All the concerns raised by I&APs were responded to and addressed during the public participation process. Specific management and mitigation measures have been considered in this Environmental Authorisation and EMPr, in order to address the concerns raised.

The Competent Authority notes the Environmental Assessment Practitioner's responses to the issues raised during the public participation process and has included appropriate conditions in this Environmental Authorisation and in the EMPr.

## 2. Alternatives

Layout alternatives were assessed as part of the application and are discussed below.

### Alternative 1 (Herewith Authorised):

The proposal entails the development of a public cemetery and memorial park that will comprise:

- A traditional grave area which allows for whole-body burials in traditional underground graves with headstones.
- An informal zone. This zone is non-traditional burial sites within a memorial park/landscaped park/garden area with lawn plaques/or a tree of remembrance/tree as headstone. The zone will incorporate the outspan in the southern section of the site and wetland buffer zones of 25m to 30m for watercourses.
- A columbarium and defined zone. These zones are non-traditional burial sites that comprise of formalized/built, above ground areas where either individual or group burials will take place. These areas include structures with niche/small spaces for placing cremated/legally reduced remains in urns or other approved containers, memorial walls with plaques of remembrance, floor plaques/flat headstones and mausoleums or crypts.
- A defined zone that includes an area for family and group burials and a heroes acre.
- An access road that will be constructed at a dedicated two-way intersection of the R304 at approximate KM 50,37.
- Internal roads of 8m wide near the entrance and around the bus parking and narrower roads for access to other regions within the cemetery and memorial park.
- A perimeter fence with main access gates and an entrance wall on the northern boundary.
- Boardwalks and wooden bridges.
- Gabion lined drift.
- An irrigation reservoir.
- A memorial park center and service zone consisting of:
  - A chapel,
  - Offices and a storage area,
  - Ablution facilities,
  - A workshop,
  - A plant/sapling nursery,
  - Staff accommodation, and
  - A gathering space.
- A sewer treatment plant and network.
- A storm water network and treatment plant. The subsurface storm water network will discharge storm water into a reed bed/storm water treatment system. A storm water attenuation pond will form part of the storm water management system.
- A security route along the boundary of the site.

This alternative is preferred as the layout plan accommodates wetland buffer zones between 25m and 30m, whilst providing ample memorial park/garden space to the west of the site. The additional crossing over the non-perennial drainage line will also enable the security team to have ease of access to the entire site during monitoring of the route. This alternative does not locate the conservancy tank/sewer treatment plant within the wetland buffer zone and makes provision for two storm water treatment plants and a storm water retention pond within the storm water network.

### Alternative 2:

This alternative is similar to Alternative 1, with the exception of the wetland buffer zones ranging between 10m and 15m, structures (maintenance and nursery building) as well as cultivated areas

(orchards) within the wetland buffer zones and the conservancy tank being located in the wetland buffer zone and in close proximity to the non-perennial drainage line.

This alternative is not preferred since the layout does not allow for the maximum wetland buffer zones to be established and it places structures (maintenance and nursery building) as well as cultivated areas (orchards) in areas that are to be rehabilitated and maintained as part of a park. Additionally, the location of the conservancy tank within the wetland buffer zone is not appropriate and this alternative does not make provision for an effluent treatment plant or a retention pond.

#### Alternative 3:

This alternative is similar to Alternative 2, except that the access road off the R304 is located at KM 50,58.

This alternative is not preferred for the same reasons as provided for Alternative 2. In addition, this alternative is not preferred as it does not take the Final Traffic Study's recommendation into consideration that the access road off the R304 must be located at KM 50.37.

#### "No-Go" Alternative

The "no-go" option to not develop a public cemetery and memorial park was considered. However, it is not preferred because it will not address the need for additional burial space within Stellenbosch Municipality, which currently has very limited burial space at existing cemeteries.

### **3. Impact Assessment and Mitigation measures**

#### 3.1 Activity Need and Desirability

There is currently a shortage of land within Stellenbosch Municipality for the development of public cemeteries. The existing public cemeteries within Stellenbosch Municipality are nearing maximum occupation and alternative land for public cemeteries is needed. The proposed public cemetery and memorial park will address the limited burial space within the municipality. The specialist studies conducted during the EIA process has informed the layout of the site to avoid and mitigate impacts and provide the best practicable environmental option.

#### 3.2 Biodiversity and Biophysical Impacts

According to the Botanical Statement dated 30 January 2019, compiled by Mr. P. Botes of PB Consulting, the site would have been historically comprised of Swartland Shale Renosterveld, an ecosystem listed as critically endangered in terms of Section 52 of the National Environmental Management Biodiversity Act, 2004 (Act No. 10 of 2004) ("NEMBA"). The site is however, overgrown by a dense mix of alien invasive vegetation and approximately 5% of the site contains hardy shrubs or pioneer species. The site has been previously disturbed by sand mining, as well as harvesting and dumping, which has further degraded the area. The Botanical Statement concluded that the proposed development will not have any significant impact on indigenous vegetation. Through the implementation of the EMPr (accepted in Section E, Condition 9), the impact on indigenous vegetation will be limited.

According to the Freshwater Impact Assessment dated May 2019, compiled by Mr. J. Gericke of EnviroSwift, a non-perennial drainage line and a mosaic of depression wetlands were identified and delineated. The northern section of the non-perennial drainage line (between the northern boundary and northernmost wetland) is artificial and has been excavated historically. This may have been a measure to drain the northernmost wetland. The rest of the non-perennial drainage line is natural and has been subjected to substantial erosion, which is related to the presence of alien invasive vegetation. The present ecological state of the non-perennial drainage line is

classified as being largely modified, since there has been a large loss of natural habitat, biota and ecosystem functions. The ecological importance and sensitivity of the non-perennial drainage line is deemed to be moderate, since it has been severely impacted by alien invasive vegetation and the introduction of storm water runoff from the R304. However, rehabilitation is not excessively difficult, since the natural course seems to be intact. The mosaic of depression wetlands was delineated within the southern and north-western portion of the site. They are largely modified and have a moderate ecological importance. Through the implementation of the EMPr (accepted in Section E, Condition 9) and FRMMP (adopted in Condition 10), the impact on the non-perennial drainage line and depression wetlands will be mitigated.

Furthermore, a Water Use Licence Application ("WULA") in terms of the National Water Act, 1998 (Act 38 of 1998) will be submitted to the Department of Water and Sanitation, that will assess the water related impacts further.

A FRMMP has been compiled to address future maintenance activities taking place in the affected watercourse. The maintenance of the structures authorised in this Environmental Authorisation forms part of this FRMMP. It must be noted that the accepted maintenance activities only relate to the activities described in the FRMMP. Should any new activities and associated infrastructure, not included in the FRMMP, require maintenance and if any of the applicable listed activities are triggered, an Environmental Authorisation must be obtained prior to the undertaking of such activities. It remains the responsibility of the proponent to determine if any other listed activities are triggered and to ensure that the necessary Environmental Authorisation is obtained.

The fact that the FRMMP is adopted by the Competent Authority does not absolve the applicant from its general "duty of care" set out in Section 28(1) of the NEMA, which states that *"Every person who causes, has caused or may cause significant pollution or degradation of the environment must take reasonable measures to prevent such pollution or degradation from occurring, continuing or recurring, or, in so far as such harm to the environment is authorised by law or cannot reasonably be avoided or stopped, to minimise and rectify such pollution or degradation of the environment."* (Note: When interpreting their "duty of care" responsibility, cognisance must be taken of the principles of sustainability contained in Section 2 of NEMA).

### 3.3 Geohydrological Impacts

According to the Geohydrological Assessment dated 23 October 2018, compiled by Mr. C. Peek of Geohydrological and Spatial Solutions International (Pty) Ltd, the site is located on a fractured aquifer. Most of the site is classified as having a low/medium groundwater vulnerability rating. The southern portion of the site has been classified as medium grading into a very high vulnerability classification. Traditional burial sites have however, been located in the north eastern and eastern section, which is away from the medium to very high vulnerability areas to avoid potential impacts on groundwater. Through the implementation of the EMPr (accepted in Section E, Condition 9), groundwater impacts will be mitigated.

### 3.4 Heritage Impacts

According to the Heritage Impact Assessment dated November 2018, compiled by New World Associates, no fossil remains were recorded during the palaeontological site visit, therefore it is unlikely to expect significant impacts palaeontological heritage. No pre-colonial archaeological heritage and no buildings, structures or features were encountered during the field assessment. Impacts on archaeological heritage is not anticipated. The proposed public cemetery and memorial park will have a medium impact and significance on the landscape, in terms of the visual impact associated with the development. An outspan has been identified in the south

western corner of the site. The area containing the outspan has however, been included in the informal park zone, to preserve the significance of this heritage feature within this landscape. Through the implementation of the EMPr (accepted in Section E, Condition 9), impacts on heritage resources will be mitigated.

### 3.5 Traffic Impacts

According to the Traffic Impact Assessment dated March 2019, compiled by Sturgeon Consulting (Pty) Ltd, the proposed new intersection at the northern boundary (KM 50,37) of the site will operate at acceptable levels of service.

The development will result in both negative and positive impacts.

#### **Negative Impacts:**

- There will be a minimal impact on the remaining indigenous vegetation.
- Impacts on the watercourse is expected during construction, however, rehabilitation of the stream will be undertaken.

#### **Positive impacts:**

- Additional land for burial will become available.
- The non-perennial drainage line and wetlands will be rehabilitated.
- Alien invasive plants will be removed.
- Employment opportunities will be created during the construction and operational phases.

## 4. National Environmental Management Act Principles

The NEMA Principles (set out in Section 2 of the NEMA, which apply to the actions of all Organs of State, serve as guidelines by reference to which any Organ of State must exercise any function when taking any decision, and which must guide the interpretation, administration and implementation of any other law concerned with the protection or management of the environment), *inter alia*, provides for:

- the effects of decisions on all aspects of the environment to be taken into account;
- the consideration, assessment and evaluation of the social, economic and environmental impacts of activities (disadvantages and benefits), and for decisions to be appropriate in the light of such consideration and assessment;
- the co-ordination and harmonisation of policies, legislation and actions relating to the environment;
- the resolving of actual or potential conflicts of interest between organs of state through conflict resolution procedures; and
- the selection of the best practicable environmental option.

## 5. Conclusion

In view of the above, the NEMA principles, compliance with the conditions stipulated in this Environmental Authorisation, and compliance with the EMPr, the Competent Authority is satisfied that the proposed listed activities will not conflict with the general objectives of integrated environmental management stipulated in Chapter 5 of the NEMA and that any potentially detrimental environmental impacts resulting from the listed activities can be mitigated to acceptable levels.

-----END-----

# **APPENDIX 6**

**NOTICE OF MUNICIPAL PLANNING  
TRIBUNAL MEETING  
OF STELLENBOSCH MUNICIPALITY  
WEDNESDAY, 2020-09-23 FROM 10:00-15:00**



**STELLENBOSCH**  
STELLENBOSCH • PNIEL • FRANSCHHOEK  
MUNISIPALITEIT • UMASIPALA • MUNICIPALITY

**NOTICE OF MUNICIPAL PLANNING TRIBUNAL MEETING  
OF STELLENBOSCH MUNICIPALITY  
WEDNESDAY, 2020-09-23 FROM 10:00-15:00**

Ref. no. 3/4/5/2/40

2020-09-23

**Chairperson**

Dr DJ Du Plessis

**Deputy-Chairperson**

Ms C Havenga

**External Members**

Mr C Rabie

Dr R Pool-Stanvliet

Mrs H Crooijmans-Lemmer

Mr J Knight

Mr E Delpont

**Internal Members**

Mr B de la Bat: Manager - Spatial Planning

Mr M Williams: Senior Legal Advisor

Mr S van der Merwe: Environmental Planner

Ms J Mowers: Senior Manager: Development, Asset Management and Systems & Project Management Unit (PMU): Infrastructure Services

Ms M Francis: Manager- Project Management Unit

Mr G Cain: Manager- IDP & Performance Management

Mr A van der Merwe: Senior Manager-Community Services

**Technical Advisor**

Mr K Munro: Director Environmental & Spatial Planning: Department of Environmental Affairs and Development Planning

*Notice is hereby given in terms of Section 75(1) of the Stellenbosch Municipality Land Use Planning By-Law (2015), of the Municipal Planning Tribunal Meeting which will be held via **MS TEAMS (Virtual Meeting)** on **WEDNESDAY, 2020-09-23 from 10h00-15:00** to consider the items on the Agenda.*

---

Dr DJ Du Plessis

**CHAIRPERSON: MUNICIPAL PLANNING TRIBUNAL**





# STELLENBOSCH

STELLENBOSCH • PNIEL • FRANSCHHOEK

MUNISIPALITEIT • UMASIPALA • MUNICIPALITY

ITEM	SUBJECT	PAGE NUMBER
1.	OPENING AND WELCOME	I N D E X  P A G E S
2.	LEAVE OF ABSENCE	
3.	DISCLOSURE OF INTERESTS	
4.	MINUTES OF THE PREVIOUS MEETING DATED 28 AUGUST 2020	3 - 34
5.	MATTERS FOR CONSIDERATION	
5.1	APPLICATION FOR CONSOLIDATION, REZONING, SUBDIVISION AND CONSENT USE ON FARM 1075/9 AND FARM 1070 PAARL DIVISION (LU/4731)	35 - 647
6.	OTHER MATTERS	

**MINUTES: STELLENBOSCH MUNICIPAL PLANNING TRIBUNAL 28 AUGUST 2020**

**MINUTES OF THE STELLENBOSCH MUNICIPAL PLANNING TRIBUNAL MEETING  
HELD ON FRIDAY, 28<sup>TH</sup> OF AUGUST 2020, via MS TEAMS 10H00-15H00**

**Ref. no. 3/4/5/2/40**

**2020-08-28**

Chairperson

Dr DJ Du Plessis

Deputy Chairperson

Ms C Havenga

External Members

Mr C Rabie

Dr R Pool-Stanvliet

Mrs H Crooijmans-Lemmer

Mr J Knight

Mr E Delpont

Internal Members

Mr B de la Bat: Manager Spatial Planning

Mr M Williams: Senior Legal Advisor

Mr S van der Merwe: Environmental Planner

Ms J Mowers- Senior Manager: Development, Asset Management and Systems & Project Management Unit -Infrastructure Services

Ms M Francis: Manager Project Management Unit

Mr G Cain: Manager IDP & Performance Management

Mr A van der Merwe: Senior Manager: Community Services

Technical Advisor

Mr K Munro: Director Development Management; Department of Environmental Affairs and Development Planning

Officials

Mr S Carstens: Senior Manager Development Management

Ms C Kriel: Manager Land Use Management

Ms L Guntz: Senior Town Planner

Mr R Fooy: Senior Town Planner

Mr P April: Senior Town Planner

Ms B Zondo: Senior Town Planner

Mrs S Zangqa: Town Planner

Ms L Kamineth: Senior Administrative Officer

## MINUTES: STELLENBOSCH MUNICIPAL PLANNING TRIBUNAL 28 AUGUST 2020

ITEM	SUBJECT
<b>SMPT</b> <b>01/08/20</b>	<b>OPENING AND WELCOME</b> Chairperson du Plessis welcomed all to the meeting.
<b>SMPT</b> <b>02/08/20</b>	<b>LEAVE OF ABSENCE</b>
	No apologies were received.
<b>SMPT</b> <b>03/08/20</b>	<b>DISCLOSURE OF INTERESTS</b> <ol style="list-style-type: none"> <li>1. Mr Schalk van der Merwe indicated that his involvement relating to Item 5.4. should be noted. He acted as a project administrator from the Stellenbosch Municipality.</li> <li>2. Mr Albert van der Merwe also requested that his involvement in item 5.4 be noted as he was part of the planning process of the said item.</li> <li>3. Mr Kobus Munro indicated that he was involved as a consultant to the applicant in respect of item 5.1.</li> </ol>
<b>SMPT</b> <b>04/08/20</b>	<b>MINUTES OF THE PREVIOUS MEETING DATED 26 JUNE 2020</b>
	The Minutes of the previous meeting was noted.
	<b>MATTERS FOR CONSIDERATION</b>
<b>SMPT</b> <b>05/08/20</b>	<b>APPLICATION FOR CONSOLIDATION, REZONING, SUBDIVISION AND CONSENT USE ON FARM 1075/9 &amp; FARM 1070, PAARL DIVISION</b> <b>Discussion:</b> <ol style="list-style-type: none"> <li>a) Chairperson Du Plessis announced the first item on the agenda and handed over to Ms Zondo to present a summary of the application.</li> <li>b) Members of the tribunal expressed various concerns with regard to the Dirkie Uys Road reserve, specifically with regard to the status of the servitude as well as the future widening of the road. The Technical Advisor referred to paragraph (d) in the Engineering condition on pages 416 and 417 of the agenda where the conditions are laid down with regard to the</li> </ol>

Dirkie Uys Road upgrade. He confirmed that Dirkie Uys road leading to the access gate of the subject properties, is a public road and indicated that an additional Traffic Impact Study was done by SMEG containing a statement regarding the upgraded cross-section and road reserve for Dirkie Uys Road.

- c) Indications were given by Mr April that in his understanding, the subject road (through the proposed development) is currently a servitude road in favour of agricultural properties and that is not a proclaimed public road.
- d) Tribunal member Mr Rabie referred to the engineers report and enquired who will be responsible for the refuse removal.
- e) Mr Rabie requested that the Conveyancer Certificate form part of Annexure B.
- f) An in-depth discussion followed between the members of the Tribunal.
- g) Chairperson du Plessis concluded that there are a couple of technical issues that were not resolved which made the tribunal hesitant to approve the application in its current format.

**UNANIMOUSLY RESOLVED:**

**THE APPLICATION BE REFERRED BACK TO THE ADMINISTRATION TO ADDRESS THE FOLLOWING:**

1. The Subdivision Plan be amended to indicate the servitude road as a public road with the Public Road Zoning as per the former Franschoek Zoning Scheme;
2. Indicate the subdivision and dimensions of the electrical substation to the satisfaction of the Electrical Engineer;
3. The Infrastructure services servitude be indicated on the Western Boundary of the development;
4. The status of the servitude road traversing the subject properties be clarified, including the legal affect of the conversion thereof to a public road as well as the effect on those who is in favour, should the servitude be registered;
5. The implication of the long period since the advertising was done needs to be clarified;
6. Provision for refuse removal to be addressed ;
7. The structural road design be addressed as a condition of approval.

<p>SMPT 06/08/20</p>	<p><b>APPLICATION FOR SUBDIVISION, CLOSURE OF PUBLIC PLACE, REZONING, CONSOLIDATION AND A DEPARTURE: ERF 1956, ERF 1957, UNREGISTERED ERF 6487 &amp; UNREGISTERED ERF 6488, VICTORIA STREET, STELLENBOSCH</b></p> <p><b>DISCUSSION:</b></p> <ul style="list-style-type: none"> <li>a) Chairperson introduced the next item and handed over to Ms Guntz to present a summary of application.</li> <li>b) Tribunal member Dr Pool-Stanvliet indicated that she support the application; however she was slightly concerned about the under provision of parking.</li> <li>c) Tribunal member Mrs Crooijmans-Lemmer motivated that the property is situated next to a big parking area which will assist with the parking concerns, thus she supports the application.</li> <li>d) Tribunal member Mr Rabie indicated that there was no Power of Attorney that was part of the documents. Ms Guntz confirmed that said document is on file and that she can furnish the tribunal members with the document.</li> <li>e) An in-depth discussion followed between the members of the Tribunal.</li> </ul> <p><b>UNANIMOUSLY RESOLVED:</b></p> <ol style="list-style-type: none"> <li>1. <b>Approval be granted</b> in terms of Section 60 of the Stellenbosch Municipal Land Use Planning By-Law, promulgated by notice number 354/2015 dated 20 October 2015, on Erf 1956, Erf1957, Unregistered Erf 6487 &amp; Unregistered Erf 6488 for: <ul style="list-style-type: none"> <li>1.1 <b>Subdivision</b> in terms of Section 15(2)(d) of the said Bylaw of Erf 1957, Stellenbosch into two portions namely Portion A (±60,03m<sup>2</sup>) and Remainder (42,97m<sup>2</sup>); as indicated on <i>Drawing Nr. 19P001-Erf1957-TRP-SUB001-F-20190710-Rev00, drawn by Plan4SA Professional Planners and Project Managers.</i></li> <li>1.2 <b>Closure of public parking place</b> in terms of Section 15(2)(n) of the said Bylaw for: <ul style="list-style-type: none"> <li>a) Erf 1956, Stellenbosch (measuring ±79m<sup>2</sup> in extent); and</li> <li>b) the newly subdivided Portion A (measuring ±60,03m<sup>2</sup> in extent.)</li> </ul> </li> <li>1.3 <b>Rezoning</b> in terms of the Section 15(2)(a) of the said Bylaw of:</li> </ul> </li> </ol>
--------------------------	--

- a) Erf 1956, Stellenbosch from Local Authority (Public Parking) to General Business be used as a business development incubator (hub) which will include office and shop uses.
- b) The newly subdivided Portion A from Local Authority (Public Parking) to General Business be used as a business development incubator (hub) which will include office and shop uses.
- c) Unregistered Erf 6487 (a portion of Erf 1956), Stellenbosch from Local Authority (General) to General Business to be used as a business development incubator (hub) which will include office and shop uses.
- d) Unregistered Erf 6488 (a portion of Erf 1957), Stellenbosch from Local Authority (General) to General Business to be used as a business development incubator (hub) which will include office and shop uses.

1.5 Consolidation in terms of Section 15(2)(e) of the said Bylaw of Unregistered Erf 6487 ( $\pm 214\text{m}^2$  in extent), Unregistered Erf 6488 ( $\pm 202\text{m}^2$  in extent), Erf 1956 ( $\pm 79\text{m}^2$  in extent) and subdivided Portion A ( $\pm 60,03\text{m}^2$  in extent) into Consolidated Erf A, being approximately  $555,03\text{m}^2$  in extent, as indicated on Drawing Nr. 19P001-E1956/1957-TRP-CP001-F-20190710-Rev00, drawn by Plan4SA Professional Planners and Project Managers.

1.6 Departure in terms of Section 15(2)(b) of the said Bylaw for the under-provision of parking (4 bays instead of 14,47 bays).

#### REASONS FOR APPROVAL:

1. The proposal will not have a negative impact on the surrounding properties and their rights as it is in keeping with the character of the area.
2. The proposed land use will improve the quality and functionality of the existing under-utilized public facilities.
3. The proposed LED hub is within walking distance to public transport routes and other businesses and will reduce vehicular movement in

town.

4. The under-provision of parking will not have a negative impact on the environment since the property is situated next to the municipal parking area.
5. The business incubator (LED Hub) will provide entrepreneurs, start-up businesses and SMME'S access to rental space, shared basic business services and equipment as well as technology support services.

**2. The approval in Section 1 is SUBJECT TO the following conditions in terms of Section 66 of the said Bylaw:**

- 2.1 The approval applies only to the proposed application, and shall not be construed as authority to depart from any other legal prescriptions or requirements from Council.
- 2.2 The approval will lapse if not implemented within the timeframe stipulated in the subject Bylaw.
- 2.3 A site development plan be submitted for approval to the Authorised Official
- 2.4 The newly created erf only have one (1) water connection and one (1) sewer connection. The position of the connections be indicated on the building plans (**any other existing connections to be blanked out**).
- 2.5 Any signage be designed in a sympathetic way and an application be submitted for approval to the Heritage Section at Stellenbosch Municipality (Planning and Economic Development Department). No neon or internally illuminated signage will be allowed.
- 2.6 The historic back wall may not be demolished, but be retained for its historical significance. Access through a pedestrian gate or, in the event of motor vehicles being parked inside the back yard, a solid motor gate.
- 2.7 No electrical fencing, barbed wire or spikes be allowed on the

	<p>historical walls surrounding the property.</p> <p>2.8 Building plans be submitted to the Municipality for approval.</p> <p>3. Matters on the application <b>TO BE NOTED:</b></p> <p>3.1 Business licence and a liquor licence be applied for, if required.</p> <p>3.2 The consultant must provide the Department: Spatial Planning with a permit from Heritage Western Cape for any additions and alterations to the existing structure older than 60 years before a building plan can be approved.</p>
<p><b>SMPT</b> <b>07/08/20</b></p>	<p><b>APPLICATION FOR THE REZONING AND SUBDIVISION OF ERF 579, FRANSCHHOEK MATTERS FOR CONSIDERATION</b></p> <p><b>DISCUSSION:</b></p> <p>a) Chairperson du Plessis handed over to Mr Fooy who presented a summary of the application.</p> <p>b) The Chairperson provided an opportunity to Mr Dreyer from David Hellig Planners to conduct his oral presentation.</p> <p>c) Chairperson brought it to the attention of the members that the objectors were invited to participate in the oral presentation but however did not respond to the invitation.</p> <p>d) Members of the Tribunal had various concerns on whether the subject property was situated inside or outside the urban edge. Tribunal member, Mr Williams enquired whether the application was located inside or outside the urban edge when submitted in 2018. Tribunal member Mr de la Bat indicated that the subject property was never inside the urban edge as it was always excluded. Mr Carstens indicated that Mr de la Bat already responded and that he would like to confirm that the subject property is outside the urban edge. Mr Spencer indicated that it was previously indicated to them that the subject property was inside the urban edge. Tribunal member Ms Havenga asked why the recommendations of the Stellenbosch Heritage Inventory and Management Plan were not reflected in the specialist studies accompanying the application.</p> <p>e) Tribunal member Mrs Crooijmans-Lemmer enquired about what type of</p>



development is permissible on the subject property in terms of the current zoning thereof. Mr Fooy indicated in terms of the new zoning allocated in terms of the 2019 zoning scheme, a church can be developed on the property.

- f) Tribunal member Mr Rabie enquired if the application was submitted prior to new zoning scheme, whether the Municipality would be under obligation to approve an application if it complied with relevant policies. Mr Carstens replied to Mr Rabie's question.
- g) Tribunal member Dr Pool-Stanvliet indicated that this is a challenging application. She indicated that in the pre-consultation minutes on page 359 of the agenda it stated that the site was within the urban edge. She requested that the Administration take caution to not create expectations as applicants appoint several consultants which is an expensive exercise.
- h) Chairperson du Plessis enquired about the reason for the long delay between the date of the Department of Spatial Planning's comments dated May 2019 and these comments apparently being made known to the applicant during April 2020.
- i) Mr Munro stated that the Tribunal must decide whether there is justification to deviate from the provisions of the municipal spatial development framework. If the Tribunal cannot find justification then legislation is clear that it cannot be allowed.
- j) Tribunal member Mrs Hedwig Crooijmans-Lemmer indicated that there is no special reason to deviate from the SDF. Deputy Chairperson Havenga indicated that the applicant did not convincingly motivate site specific circumstances to support this deviation from the SDF.

UNANIMOUSLY RESOLVED:

1. Approval not be granted in terms of Section 60 of the Stellenbosch Municipal Land Use Planning By-Law, promulgated by notice number 354/2015 dated 20 October 2015, applications submitted on the grounds of Site-Specific Deviation from the Stellenbosch MSDF, 2019 for:

1.1 Rezoning of Erf 579, Franschhoek to Subdivisional Area in terms of Section 15(2)(a) of the Bylaw to allow for the following uses:

- i. 56 Group Housing portions,
- ii. 1 Private Open Space portion,

iii. 1 Private Open Space (For road purposes)

1.2 Subdivision of Erf 579, Franschhoek to create the following erven:

- i. 56 Group Housing portions
- ii. 1 Private Open Space portion
- iii. 1 Private Open Space (For road purposes)

REASONS FOR REFUSAL:

1. The MSDF as supported by the Heritage Inventory and Management Plan is regarded as relevant to this area and the Site-Specific Deviation presented is not viewed as credible grounds for the purpose of the proposed group housing development to deviate from the MSDF.
2. The subject property is located outside the urban edge and the proposal as submitted does not comply with the principles of the Stellenbosch Integrated Development Plan and the Municipal Spatial Development Framework.
3. Franschhoek is not identified as a growth node by the MSDF and thus the incorporation of properties outside the urban edge is not promoted.
4. The MSDF only focus on inward development of land within the of town of Franschhoek and the subject property is located on the outer edge of Franschhoek.
5. The re-development of the subject property to establish a gated group housing development is seen to be out of character with the surrounding area and the density proposed is too high for the area in which the property is located.
6. The proposal has not taken its surroundings into consideration as the subject property forms part of the "transition zone" between the urban and rural areas of Franschhoek and the proposal submitted does not reflect this.
7. The proposal has not taken the recommendations of the Heritage Inventory and Management Plan for the area into consideration and thus has not addressed the cultural impact that the proposed development will have on the area.

<p>SMPT 08/08/20</p>	<p><b>APPLICATION FOR REZONING AND SUBDIVISION ON FARM 742/2, PAARL DIVISION</b></p> <p><b>DISCUSSION:</b></p> <ul style="list-style-type: none"> <li>a) Chairperson du Plessis handed over to Mrs Zangqa to present a summary of the application.</li> <li>b) He later announced the application open for discussion.</li> <li>c) Tribunal member Mrs Croojmans-Lemmer questioned the size of the area required for the school.</li> <li>d) Clarification was requested regarding access routes to the sites.</li> <li>e) An in-depth discussion followed between the members of the Tribunal.</li> </ul> <p><b>UNANIMOUSLY RESOLVED:</b></p> <p><b>1. Approval be granted in terms of Section 60 of the Stellenbosch Municipal Land Use Planning By-Law, promulgated by notice number 354/2015 dated 20 October 2015, for:</b></p> <p><b>1.1 Rezoning of Farm 742/2, Paarl Division from Agricultural Zone I to Subdivisional Area in terms of Section 15(2)(a) of the said Bylaw to allow for the following uses as depicted on plan number 674/1, dated October 2018 and drawn by BVZ Plan:</b></p> <ul style="list-style-type: none"> <li>i. Two (2) Institutional Zone 1 erven namely, Portion 1 (±3.3608ha) and Portion 2 (±3.4802ha) in order to accommodate schools.</li> <li>ii. One (1) Transport Zone II erf on Portion 3 (±0.7525ha) in order to provide an access road to the schools; and</li> <li>iii. One (1) Agricultural Zone I portion for the Remainder (±53.5172ha).</li> </ul> <p>1.2 Subdivision in terms of Section 15(2)(d) of the said Bylaw in accordance with the Subdivisional plan number 674/1, dated October 2018 and drawn by BVZ Plan.</p> <p><b>REASONS FOR APPROVAL:</b></p> <ul style="list-style-type: none"> <li>1. Providing schools close to communities would play an important role in the education of the local community.</li> <li>2. The facility creates employment opportunities and diversifies the</li> </ul>

economic base of the local area and region as a whole.

3. The proposed school will be located within walking distance of the existing residential areas.
4. The proposed use is not undesirable and will have minimal impact on the surrounding properties.
5. The proposal complies with the principles of the Stellenbosch Spatial Development Framework.

**2. The approval in Section 1 is SUBJECT TO the following conditions in terms of Section 66 of the said Bylaw:**

2.1 The approval applies only to the subdivision and rezoning in question, and shall not be construed as authority to depart from any other legal prescriptions or requirements from Council.

2.2 The approval granted does not exempt the applicant from complying with any other legal prescriptions or requirements that might have a bearing on the proposed use.

2.3 Building plans be approved by this Municipality, prior to any building work commencing on site.

2.4 That the following conditions as set out by the **Directorate: Engineering Services** be adhered to (see **Annexure K**):

**2.4.1 Status of bulk municipal engineering services and upgrades required:**

- a. **Water Network:** There is currently not sufficient capacity in the bulk water reticulation network to accommodate the proposed development. However, the Municipality has budgeted R30m ex VAT over the next three financial years to upgrade the bulk water supply in Klapmuts in order to create spare capacity. The development will be able to connect to the municipal water network once the upgrades have been completed and commissioned and it is currently estimated that this date will be 30 June 2022. A more accurate date will be available when building plans are submitted for approval. The developer will be responsible

for any link pipelines between the development and the municipal water network.

- b. **Roads Network:** The portion of land indicated a Road (Portion 3) on the subdivision plan must be rezoned to public road be transferred to the Municipality before clearance is given.

**c. Solid Waste:**

For large spoil volumes from excavations, to be generated during the construction of this development, will not be accepted at the Stellenbosch landfill site. The Developer will have to indicate and provide evidence of safe re-use or proper disposal at an alternative, licensed facility. This evidence must be presented to the Manager: Solid Waste (Mr Saliem Haider, [Saliem.haider@stellenbosch.gov.za](mailto:Saliem.haider@stellenbosch.gov.za)), 021 808 8241 before building plan approval and before implementation of the development.

Clean rubble can be utilized by the Municipality and will be accepted free of charge, providing it meets the required specification.

#### 2.4.2 Development Charges

- a. Development charges will be applicable and will be calculated when a detailed SDP is submitted for approval or when building plans are submitted for approval;
- b. The "**Developer**" accepts that the Development Charges will be subject to annual adjustment up to date of payment. The amount payable will therefore be the amount as calculated according to the applicable tariff structure at the time that payment is made;
- c. If the "**Developer**" may enter into an engineering services agreement with the "**Municipality**" to install or upgrade bulk municipal services at an agreed cost, to be off-set against Development Charges payable in respect of bulk civil engineering services;
- d. The Development Charges be paid by the "**Developer**" per phase – prior to the approval of any building- and/or services plans and;

**2.4.3 Site Development**

- a. A fully detailed site development plan be submitted for approval prior to the approval of engineering services plans and or building and/ or services plans to allow for the setting of requirements, specifications and conditions related to civil engineering services. Such Plan is to be substantially in accordance with the approved application and or subdivision plan and or precinct plan and or site plan, etc. and is to include a layout plan showing the position of all roads, road reserve widths, sidewalks, parking areas with dimensions, loading areas, access points, stacking distances at gates, refuse removal arrangements, allocation of uses, position and orientation of all buildings, the allocation of public and private open spaces, building development parameters, the required number of parking bays, storm water detention facilities, connection points to municipal water and sewer services, updated land-use diagram and possible servitudes;

**2.4.4 Ownership and Responsibility of services**

- a. Proposed Subdivision and Rezoning Plan Plan No 674/1 by BvZ, the internal services on the said erven will be regarded as private services and will be maintained by the "Developer" and or Owner's Association;

**2.4.5 Internal- and Link Services**

- a. The "**Developer**", at his/her cost, construct the internal (on-site) municipal civil services for the development, as well as any link (service between internal and available bulk municipal service) municipal services that need to be provided;

**2.4.6 Bulk Water Meter**

- a. The "**Developer**" shall install a bulk water meter conforming to the specifications of the Directorate: Engineering Services at his

cost at the entrance gate and that clearance will only be issued if the bulk water meter is installed, a municipal account for the said meter is activated and the consumer deposit has been paid;

#### **2.4.7 Damage to municipal services**

- a. The "**Developer**" will be held liable for any damage to municipal infrastructure within the road reserves of the roads, caused as a direct result of the development of the subject property. The "**Developer**" will therefore be required to carry out the necessary rehabilitation work, at his/her cost, to the standards of the Directorate: Infrastructure Services;
- b. The "**Developer**" will enter into an Engineering Services Agreement with the "**Municipality**" in respect of the implementation of the infrastructure to be implemented in lieu of DCs if the need for such infrastructure is identified at any stage by the Municipality;
- c. Should the "**Developer**" not take up his rights for whatever reason within two years from 12 November 2019 a revised Engineering report addressing services capacities and reflecting infrastructure amendments during the two year period, must be submitted to the Directorate: Infrastructure Services by the "**Developer**" for further comment and conditions. Should this revised Engineering report confirm that available services capacities is not sufficient to accommodate this development, then the implementation of the development must be re-planned around the availability of bulk services as Section 28 Certification in terms of the Stellenbosch Municipal Land Use Planning By-law will not be supported by the Directorate: Infrastructure Services for the development if bulk services are not available upon occupation or taking up of proposed rights;
- d. The "**Developer**" indemnifies and keep the "**Municipality**" indemnified against all actions, proceedings, costs, damages, expenses, claims and demands (including claims pertaining to consequential damages by third parties and whether as a result of the damage to or interruption of or interference with the

municipalities' services or apparatus or otherwise) arising out of the establishment of the development, the provision of services to the development or the use of servitude areas or municipal property, for a period that shall commence on the date that the installation of services to the development are commenced with and shall expire after completion of the maintenance period.

- e. The "Developer" ensures that he / she has an acceptable public liability insurance policy in place;
- f. The "Developer" approach the Provincial Administration: Western Cape (District Roads Engineer) for their input and that the conditions as set by the Provincial Administration: Western Cape be adhered to before Section 28 Certification in terms of the Stellenbosch Municipal Land Use Planning By-law will be issued;
- g. The "Developer" informs the project team for the proposed development (i.e. engineers, architects, etc.) of all the relevant conditions contained in this approval;
- h. The General Conditions of Contract for Construction Works (GCC) applicable to all civil engineering services construction work related to this development, will be the SAICE 3<sup>rd</sup> Edition (2015);
- i. Should the "Developer" wish to discuss the possibility of proceeding with construction work parallel with the provision of the bulk services listed above, he present a motivation and an implementation plan to the "Engineer" for his consideration and approval. The implementation plan should include items like programmes for the construction of the internal services and the building construction. Only if the programme clearly indicates that occupation is planned after completion of the bulk services, will approval be considered. If such proposal is approved, no occupation certificate will be issued prior to the completion and commissioning of the bulk services. Should the proposal for proceeding with the development's construction work parallel with the provision of the bulk services be agreed to, the onus is on the "Developer" to keep up to date with the status in respect of capacity at infrastructure listed above in



order for the "Developer" to programme the construction of his/her development and make necessary adjustments if and when required. The Developer is responsible for stipulating this condition in any purchase contracts with buyers of the properties;

j. The "Developer" takes cognizance and accepts the following:

- i. No construction of any civil engineering services may commence before approval of internal – and external civil engineering services drawings;
- ii. No approval of internal – and external civil engineering services drawings will be given before land-use and or SDP approval is obtained;
- iii. No approval of internal – and external civil engineering services drawings will be given before the "Developer" obtains the written approval of all affected owners where the route of a proposed service crosses the property of a third party;
- iv. No building plans will be recommended for approval by the Directorate: Infrastructure Services before land-use and or SDP approval is obtained;
- v. No building plans will be recommended for approval by the Directorate: Infrastructure Services before the approval of internal – and external civil engineering services drawings;
- vi. No building plans will be recommended for approval by the Directorate: Infrastructure Services before a Section 28 Certification in terms of the Stellenbosch Municipal Land Use Planning By-law is issued.

#### **2.4.8 Internal- and Link Services**

- a. The Directorate: Infrastructure Services may require the "Developer" to construct internal municipal services and/or link services to a higher capacity than warranted by the project, for purposes of allowing other existing or future

- developments to also utilise such services. The costs of providing services to a higher capacity could be offset against the Development Charges payable in respect of bulk civil engineering services if approved by the Directorate: Infrastructure Services;
- b. The detailed design and location of access points, circulation, parking, loading – and pedestrian facilities, etc., shall be generally in accordance with the approved Site Development Plan and / or Subdivision Plan applicable to this application;
- c. Plans of all the internal civil services and such municipal link services as required by the Directorate: Infrastructure Services be prepared and signed by a Registered Engineering Professional before being submitted to the aforementioned Directorate for approval;
- d. Construction of services may only commence after municipal approval has been obtained;
- e. The construction of all civil engineering infrastructure shall be done by a registered civil engineering services construction company approved by the “Engineer”;
- f. The “Developer” ensures that his/her design engineer is aware of the Stellenbosch Municipality Design Guidelines & Minimum Standards for Civil Engineering Services (as amended) and that the design and construction/alteration of all civil engineering infrastructure
- g. Be generally in accordance with this document, unless otherwise agreed with the Engineer. The said document is available in electronic format on request;
- h. A suitably qualified professional resident engineer be appointed to supervise the construction of all internal – and external services;
- i. Engineering design drawings will only be approved once approval in terms of the Stellenbosch Municipal Land Use Planning By-law is issued;
- j. All the internal civil services (water, sewer and storm water), be indicated on the necessary building plans for approval by the Directorate: Infrastructure Services;

- k. Prior to the issuing of the Certificate of Practical Completion, in terms of GCC 2015 Clause 5.14.1, all internal - and link services be inspected for approval by the "Engineer" on request by the "Developer's" Consulting Engineer;
- l. Certificate of Practical Completion, in terms of GCC 2015 Clause 5.14.1 be issued before Section 28 Certification in terms of the Stellenbosch Municipal Land Use Planning Bylaw will be issued (prior to transfer of individual units or utilization of buildings);
- m. A complete set of test results of all internal – and external services (i.e. pressure tests on water - and sewer pipelines as well as densities on road structure and all relevant tests on asphalt), approved and verified by a professional registered engineer be submitted to the "Engineer" on request;
- n. The "Developer" shall adhere to the specifications of Telkom (SA) and or any other telecommunications service provider;
- o. that the "Developer" shall be responsible for the cost for any surveying and registration of servitudes regarding services on the property;
- p. The "Developer" be liable for all damages caused to existing civil and electrical services of the "Municipality" relevant to this development. It is the responsibility of the contractor and/or sub-contractor of the "Developer" to determine the location of existing civil and electrical services;
- q. All connections to the existing services be made by the "Developer" under direct supervision of the "Engineer" or as otherwise agreed and all cost will be for the account of the "Developer".
- r. The Developer takes cognizance of applicable tariffs by Council in respect of availability of services and minimum tariffs payable;

#### **2.4.9 Servitudes**

- a. The "**Developer**" ensures that all main services including roads to be taken over by the Directorate: Infrastructure Services, all existing municipal – and or private services

including roads, crossing private - and or other institutional property and any other services/roads crossing future private land/erven are protected by a registered servitude before Section 28 Certification in terms of the Stellenbosch Municipal Land Use Planning By-law will be given;

- b. The width of the registered servitude must be a minimum of 3 m or twice the depth of the pipe (measured to invert of pipe), whichever is the highest value. The "**Developer**" will be responsible for the registration of the required servitude(s), as well as the cost thereof;
- c. The "**Developer**" obtains the written approval of all affected owners where the route of proposed service crosses the property of a third party before final approval of engineering drawings be obtained.

#### **2.4.10 Stormwater Management**

- a. The design engineer needs to apply his/her mind to ensure a design that will promote a sustainable urban drainage system which will reduce the impacts of storm water on receiving aquatic environments;
- b. The consulting engineer, appointed by the "**Developer**", analyses the existing storm water systems and determine the expected storm water run-off for the proposed development, for both the minor and the major storm event. Should the existing municipal storm water system not be able to accommodate the expected storm water run-off, the difference between the pre and post-development storm water run-off must be accommodated on site, or the existing system must be upgraded to the required capacity at the cost of the "**Developer**" and to the standards and satisfaction of the Directorate: Infrastructure Services. The aforementioned storm water analysis is to be submitted concurrent with the detail services plans;
- c. No overland discharge of storm water will be allowed into a public road for erven with catchment areas of more than 1500m<sup>2</sup> and for which it is agreed that no detention facilities

are required. The "Developer" needs to connect to the nearest piped municipal storm water system with a storm water erf connection which may not exceed a diameter of 300mm.

#### **2.4.11 Roads**

- a. Where applicable, the application must be submitted to the District Roads Engineer for comment and conditions. Any conditions set by the District Roads Engineer will be applicable; that, prior to commencement of any demolition / construction work, a traffic accommodation plan for the surrounding roads must be submitted to the Directorate: Infrastructure Services for approval, and that the approved plan be implemented by the "Developer", at his/her cost, to the standards of the Directorate: Infrastructure Services;
- b. Visibility splays shall be provided and maintained on each side of the new access in accordance with the standard specifications as specified in the Red Book with regard to sight triangles at intersections;
- c. Each erf has its own access (drive-way), (the new access(es) (dropped kerb(s)) to the proposed parking bays be) constructed to standards as set out by the Directorate: Infrastructure Services and in line with the Road Access Guideline;
- d. The access road to the existing facility be kept in an acceptable condition, i.e. maintained to a standard which will result in a comfortable ride for a standard passenger vehicle and to a standard which will not endanger the lives or property of road users;

#### **2.4.12 Wayleaves**

- a. Way-leaves / work permits be obtained from the Directorate: Infrastructure Services prior to any excavation / construction work on municipal land or within 3,0m from municipal services located on private property;

- b. Wayleaves will only be issued after approval of relevant engineering design drawings;
- c. It is the Developer's responsibility to obtain way leaves from any other authorities/service provider's who's services may be affected.

#### **2.4.13 Solid Waste**

- a. It be noted that the Solid Waste Branch will not enter private property, private roads or any access controlled properties for the removal of solid waste;
- b. The "**Developer**" must apply and get approval from the Municipality's Solid Waste Department for a waste removal service prior to clearance certificate or occupation certificate (where clearance not applicable). Contact person Mr Saliem Haider, 021 808 8241; [saliem.haider@stellenbosch.gov.za](mailto:saliem.haider@stellenbosch.gov.za);
- c. Should it not be an option for the "**Municipality**" to enter into an agreement with the "**Developer**" due to capacity constraints, the "**Developer**" will have to enter into a service agreement with a service provider approved by the "**Municipality**" prior to clearance certificate or occupation certificate (where clearance not applicable);
- d. If the "Developer" wishes to remove the waste by private contractor, provision must still be made for a refuse room should this function in future revert back to the "Municipality";
- e. Refuse storage areas are to be provided for all premises other than single residential erven;
- f. Refuse storage areas shall be designed in accordance with the requirements as specified by the Solid Waste Branch. Minimum size and building specifications is available from the Solid Waste Branch;
- g. A single, centralized, refuse storage area which is accessible for collection is required for each complete development. The only exception is the case of a single residential dwelling, where a refuse storage area is not required;
- h. The refuse storage area shall be large enough to store all

	<p>receptacles needed for refuse disposal on the premises, including all material intended to recycling. No household waste is allowed to be disposed / stored without a proper 240 ℓ Municipal wheelie bin;</p> <p>i. The size of the refuse storage area depends on the rate of refuse generation and the frequency of the collection service. For design purposes, sufficient space should be available to store two weeks' refuse;</p> <p>j. All black 85 ℓ refuse bins or black refuse bags is in the process of being replaced with 240 ℓ black municipal wheeled containers engraved with WC024 in front, and consequently refuse storage areas should be designed to cater for these containers. The dimensions of these containers are: Commercial and Domestic: 585 mm wide x 730 mm deep x 1100 mm high</p> <p>k. With regard to flats and townhouses, a minimum of 50 litres of storage capacity per person, working or living on the premises, is to be provided at a "once a week" collection frequency;</p> <p>l. Should designers be in any doubt regarding a suitable size for the refuse storage area, advice should be sought from the Solid Waste Department: Tel 021 808-8224</p> <p>m. Building specifications for refuse storage area:</p> <p>i. Floor: The floor shall be concrete, screened to a smooth surface and rounded to a height of 75mm around the perimeter. The floor shall be graded and drained to a floor trap (See: Water Supply and Drainage).</p> <p>ii. Walls and Roof: The Refuse Storage Area shall be roofed to prevent any rainwater from entering. The walls shall be constructed of brick, concrete or similar and painted with light color high gloss enamel. The height of the room to the ceiling shall be not less than 2.21 meters.</p> <p>iii. Ventilation and Lighting: The refuse storage area shall be adequately lit and ventilated. The room shall be</p>
--	--

provided with a lockable door which shall be fitted with an efficient self-closing device. The door and ventilated area shall be at least 3 metres from any door or window of a habitable room. Adequate artificial lighting is required in the storage area.

iv. Water Supply and Drainage: A tap shall be provided in the refuse storage area for washing containers and cleaning spillage. The floor should be drained towards a 100 mm floor trap linked to a drainage pipe which discharges to a sewer gully outside the building. In some cases, a grease gully may be required.

n. Should the refuse storage area be located at a level different from the level of the street entrance to the property, access ramps are to be provided as stairs are not allowed. The maximum permissible gradient of these ramps is 1:7;

o. A refuse bay with minimum dimensions of 15 meters in length x 2, 5 meters in width plus 45 degrees splay entrance, on a public street, must be provided where either traffic flows or traffic sight lines are affected. The refuse bays must be positioned such that the rear of the parked refuse vehicle is closest to the refuse collection area;

p. Any containers or compaction equipment acquired by the building owner must be approved by the Directorate: Infrastructure Services, to ensure their compatibility with the servicing equipment and lifting attachments;

q. Refuse should not be visible from a street or public place. Suitable screen walls may be required in certain instances;

r. Access must be denied to unauthorized persons, and refuse storage areas should be designed to incorporate adequate security for this purpose;

s. All refuse storage areas shall be approved by the Directorate: Infrastructure Services, to ensure that the Council is able to service all installations, irrespective of whether these are currently serviced by Council or other



companies;

#### 2.4.14 AS-BUILTs

- a. The "Developer" shall provide the "Municipality" with:
- i. complete set of as-built paper plans, signed by a professional registered engineer;
  - ii. A CD/DVD containing the signed as-built plans in an electronic DXF-file format, reflecting compatible layers and formats as will be requested by the "Engineer" and is reflected herewith as Annexure X;
  - iii. A completed Asset Verification Sheet in Excel format, reflecting the componentization of municipal services installed as part of the development. The Asset Verification Sheet will have to be according to the IMOS format, as to be supplied by the "Engineer", and is to be verified as correct by a professional registered engineer;
  - iv. A complete set of test results of all internal – and external services (i.e. pressure tests on water - and sewer pipelines as well as densities on road structure and all relevant tests on asphalt), approved and verified by a professional registered engineer;
  - v. Written verification by the developer's consulting engineer that all professional fees in respect of the planning, design and supervision of any services to be taken over by the "Municipality" are fully paid;
- b. All relevant as-built detail, as reflected in the item above, of civil engineering services constructed for the development, must be submitted to the "**Engineer**" and approved by the "**Engineer**" before any application for Certificate of Clearance will be supported by the "**Engineer**";
- c. The Consulting Civil Engineer of the "**Developer**" shall certify that the location and position of the installed services are in accordance with the plans submitted for each of the services detailed below;

- d. All As-built drawings are to be signed by a professional engineer who represents the consulting engineering company responsible for the design and or site supervision of civil engineering services;
- e. Section 28 Certification in terms of the Stellenbosch Municipal Land Use Planning By-law shall not be issued unless said services have been inspected by the "**Engineer**" and written clearance given, by the "**Engineer**";

**2.4.15 Section 28 Certification in terms of the Stellenbosch Municipal Land Use Planning By-law**

- a. It is specifically agreed that the "**Developer**" undertakes to comply with all conditions of approval as laid down by the "**Municipality**" before clearance certificates shall be issued, unless otherwise agreed herein;
- b. The "**Municipality**" reserves the right to withhold any clearance certificate until such time as the "**Developer**" has complied with conditions set out in this contract with which he/she is in default. Any failure to pay monies payable in terms of this contract within 30 (thirty) days after an account has been rendered shall be regarded as a breach of this agreement and the "**Municipality**" reserves the right to withhold any clearance certificate until such time as the amount owing has been paid;
- c. The onus will be on the "Developer" and or his professional team to ensure that all land-use conditions have been complied with before submitting an application for a Section 28 Certification in terms of the Stellenbosch Municipal Land Use Planning Bylaw. Verifying documentation (proof of payment in respect of Development Charges, services installation, etc.) must be submitted as part of the application before an application will be accepted by this Directorate;
- d. Any application for Certificate of Clearance will only be supported by the "**Engineer**" once all relevant as-built detail, as reflected in the item "AS-BUILT's" of this document, is

	<p>submitted to the "<i>Engineer</i>" and approved by the "<i>Engineer</i>".</p> <p><b>2.4.16 Avoidance of waste, nuisance and risk</b></p> <p>a. Where in the opinion of the "<i>Municipality</i>" a nuisance, health or other risk to the public is caused due to construction activities and/or a lack of maintenance of any service, the "<i>Municipality</i>" may give the "<i>Developer</i>" and or OWNER'S ASSOCIATION written notice to remedy the defect failing which the "<i>Municipality</i>" may carry out the work itself or have it carried out, at the cost of the "<i>Developer</i>" and or OWNER'S ASSOCIATION.</p> <p>3. Matters on the application <b>TO BE NOTED:</b></p> <p>3.1 The conditions imposed by the Department of Water and Sanitation in their letter date 19 March 2020, attached as <b>Annexure H.</b></p> <p>3.2 The conditions imposed by the Manager: Spatial Planning, Heritage &amp; Environment in their letter date 14 March 2020, attached as <b>Annexure L.</b></p>
<p>SMPT 09/08/20</p>	<p><b>APPLICATION FOR REZONING FROM AGRICULTURE TO LOCAL AUTHORITY FOR THE ESTABLISHMENT OF A PUBLIC CEMETERY AND MEMORIAL PARK ON A 70HA PORTION OF FARM NO. 502, STELLENBOSCH (LOUW'S BOS)</b></p> <p><b>DISCUSSION:</b></p> <p>a) Chairperson du Plessis handed over to Mr Pedro April to present a summary of the application.</p> <p>b) Tribunal member Dr Pool-Stanvliet questioned the need for another cemetery as the Tribunal at their previous meeting approved a similar development at the Calcutta site.</p> <p>c) Tribunal member Mr van der Merwe explained that there was an extensive process to determine suitable sites for cemeteries and that there was eventually decided on two suitable sites to address the existing need. It is foreseen that Calcutta be developed first.</p> <p>d) Tribunal member Mrs Crooijmans-Lemmer enquired if the possibility of a crematorium on-site has been investigated. Tribunal member Mr Schalk van der Merwe indicated that it was investigated and if necessary can be</p>

considered in future, but is not part of the existing application.

- e) Tribunal member Albert van der Merwe further indicated the Municipality are looking at alternative burial methods, but persons cannot be forced to cremate.
- f) Tribunal member Ms Havenga questioned how the number of parking bays was determined.
- g) Tribunal member Mr Rabie indicated that the approval period of 5 years may be an issue
- h) Mr April confirmed the time period as it is 5 years
- i) Tribunal member Mr Rabie noted that if the time to develop the Calcutta cemetery be taken into consideration, it means that this application if approved, will have to be extended or it will lapse.
- j) Mr April indicated that the Stellenbosch Planning By-Law will be amended to allow for a period of 10 years, which will allow for a further extension of 5 years.
- k) An in-depth discussion followed between the members of the Tribunal.

UNANIMOUSLY RESOLVED:

1. Approval be granted in terms of Section 60 of the Stellenbosch Municipal Land Use Planning By-Law, promulgated by notice number 354/2015 dated 20 October 2015, for:

- 1.1 Rezoning of ±70ha of Farm No. 502, Stellenbosch in terms of Section 15(2)(a) of the said Bylaw from Agricultural to Local Authority for the establishment of a municipal public regional cemetery and memorial park (Louw's Bos Memorial Park).

REASONS FOR APPROVAL:

- 1. Cemeteries require limited services relative to the amount of land needed, making them inefficient users of public infrastructure and are better suited outside urban areas, to make provision for urban development within urban edges. This regional rural cemetery provides such an option to the Municipality.
- 2. The proposed cemeteries are compatible with the rural land uses, and have been designed as parks and natural spaces to compliment the surrounding agricultural community.
- 3. The establishment of these cemeteries represents a permanent land use

and will very rarely convert to another use. The future change of this site now being zoned out of agriculture for urban development is therefore unlikely, while physical features of the proposed use is complementary to the rural context it will be situated in.

4. The proposed rezoning will not affect any natural habitat or ecological corridors, although a partially uncultivated 70 ha portion of an 707 ha agricultural land unit will be used for cemetery and memorial park purposes.

2. The approval granted in Section 1 is SUBJECT TO the following conditions in terms of Section 66 of the said Bylaw:

2.1 The approval applies only to the rezoning in question, and shall not be construed as authority to depart from any other legal prescriptions or requirements from Council.

2.2 The neighbouring farms and lease hold areas right to farm and that what is normally associated with that (including boreholes, farm infrastructure and day to day farming activities but not limited to) be protected at all cost and that the cemetery and use thereof not impede in any way.

2.3 The following conditions imposed by the Manager: Spatial Planning in their memo dated 26 March 2020, attached as APPENDIX M be adhered to:

- a) The mitigation recommendation as contained in the visual impact assessment be implemented
- b) The mitigation measures contained in the Heritage Impact **assessment be implemented.**

2.4 The following conditions imposed by the **Director: Engineering Services** in their memo dated 13 March 2020, attached as **APPENDIX N** be adhered to:

**2.4.1 Waste Water and Sewage**

*The following information must be provided at building plan stage:*

- (i) *Provide details of the proposed treatment and disposal method: Manufacturer, model, type of treatment technology, will disposal be by irrigation, into a watercourse etc.*
- (ii) *If an on-site treatment plant is considered, it should preferably be*

based on the activated sludge process.

- (iii) Provide a Waste Management Plan or indicate measures to be taken for the handling of solid by-products (i.e. waste sludge, by products of the manufacturing process), including contingency plans / risk mitigation for when the processes do not perform as intended.

#### 2.4.2 Water

- (i) Before connecting to the municipal water network, a water demand report be submitted before this request can be approved;
- (ii) The alternative potable water source is indicated in this application as borehole water.
- (iii) The quality of the water stored and distributed by the owner has to comply with SANS 241 Drinking Water Quality Standards. Current proof of compliance must be available on request.

#### 2.4.3 Solid Waste

- (i) Solid waste must be removed from the site to a lawful solid waste disposal site in accordance with the requirements of section 26 of the National Environmental Management Waste Act 2008 (Act 59 of 2008).

#### 2.4.4 Roads

- (i) The Transport Impact Study Reference number: STUR 0216 dated April 2019 compiled by Sturgeon consultants is supported;
- (ii) Please refer the application to the District Roads Engineer for comment. Any conditions set by the District Roads Engineer will be applicable.
- (iii) Prior to commencement of any demolition / construction work, a traffic accommodation plan for the surrounding roads must be submitted to the Directorate: Infrastructure Services for approval.

#### 2.4.5 Stormwater Management

- (i) The geometric design of the roads, parking area and grave layout must ensure that no trapped low-points are created with regard to stormwater management.

#### 2.4.6 Electrical Engineering.

- (i) All electrical requirements must be directed to Eskom

	<p>2.5 A final detailed landscaping and site development plan, indicating the details of the proposed land development including the site layout, position and height of buildings and structures, detailed property access, building designs, landscaping and incorporating all the proposals from the specialist studies conducted, be submitted to the Directorate of Planning and Economic Development for approval;</p> <p>2.6 The approval will lapse if not implemented within the timeframe stipulated in the subject Bylaw;</p> <p>2.7 Building plans only be approved when all conditions of approval have been complied with;</p> <p>2.8 The conditions from Eskom (See <b>APPENDIX K</b>) be complied with to their satisfaction;</p> <p>2.9 The conditions stated in letter TPW/CFS/RP/LUD/REZ/SUB-25/357 (Job 27572) by the <b>Department of Transport and Public Works</b> dated 10 March 2019 (See <b>APPENDIX L</b>), be complied with to the satisfaction of the competent roads authority.</p> <p>3. Matters on the application <b>TO BE NOTED:</b></p> <p>3.1 It's the responsibility of the applicant/owner to apply and obtain a water use authorisation from the competent authority prior to construction taking place.</p> <p>3.2 The conditions imposed by the Department of Environmental Affairs and Development Planning in their letter dated 22 January 2020 (Environmental Authorisation), attached as APPENDIX G must be complied with to the satisfaction of the competent authority;</p> <p>3.3 Should any heritage resources, including evidence of graves, human burials, archaeological material and paleontological material be discovered during the execution of the cemetery and memorial construction activities, all works be stopped immediately, Heritage Western Cape be notified without delay and the owner comply with any requirements to the satisfaction of Heritage Western Cape (see APPENDIX</p>
--	--

## MINUTES: STELLENBOSCH MUNICIPAL PLANNING TRIBUNAL 28 AUGUST 2020

	J for their letter dated 02 May 2019);
SMPT 10/08/20	<b>OTHER MATTERS</b>  <ol style="list-style-type: none"><li>1. Mr Rabie indicated he is not available for the MPT meeting scheduled for the 23rd of September 2020.</li><li>2. Chairperson du Plessis thanked all for attending the sitting.</li></ol> <p>The meeting adjourned at 15h20.</p>



---

Dr D du Plessis

**CHAIRPERSON: MUNICIPAL PLANNING TRIBUNAL**

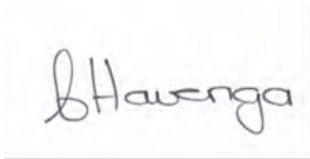

Mrs C Havenga

**DEPUTY CHAIRPERSON: MUNICIPAL PLANNING TRIBUNAL**



**NOTICE OF MUNICIPAL PLANNING  
TRIBUNAL MEETING  
OF STELLENBOSCH MUNICIPALITY  
FRIDAY, 2020-08-28 FROM 10:00-15:00**

**VOLUME 1**



**NOTICE OF MUNICIPAL PLANNING TRIBUNAL MEETING  
OF STELLENBOSCH MUNICIPALITY  
FRIDAY, 2020-08-28 FROM 10:00-15:00**

Ref. no. 3/4/5/2/40

2020-08-28

**Chairperson**

Dr DJ Du Plessis

**Deputy-Chairperson**

Ms C Havenga

**External Members**

Mr C Rabie

Dr R Pool-Stanvliet

Mrs H Crooijmans-Lemmer

Mr J Knight

Mr E Delport

**Internal Members**

Mr B de la Bat: Manager - Spatial Planning

Mr M Williams: Senior Legal Advisor

Mr S van der Merwe: Environmental Planner

Ms J Mowers: Senior Manager: Development, Asset Management and Systems & Project Management Unit (PMU): Infrastructure Services

Ms M Francis: Manager- Project Management Unit

Mr G Cain: Manager- IDP & Performance Management

Mr A van der Merwe: Senior Manager-Community Services

**Technical Advisor**

Mr K Munro: Director Environmental & Spatial Planning: Department of Environmental Affairs and Development Planning

*Notice is hereby given in terms of Section 75(1) of the Stellenbosch Municipality Land Use Planning By-Law (2015), of the Municipal Planning Tribunal Meeting which will be held via **MS TEAMS (Virtual Meeting)** on **FRIDAY, 2020-08-28 from 10h00-15:00** to consider the items on the Agenda.*

---

Dr DJ Du Plessis

**CHAIRPERSON: MUNICIPAL PLANNING TRIBUNAL**



ITEM	SUBJECT	PAGE NUMBER
1.	OPENING AND WELCOME	I N D E X  P A G E S
2.	LEAVE OF ABSENCE	
3.	DISCLOSURE OF INTERESTS	
4.	MINUTES OF THE PREVIOUS MEETING DATED 26 JUNE 2020	3 -14
5.	VOLUME 1	
5.1	APPLICATION FOR CONSOLIDATION, REZONING, SUBDIVISION AND CONSENT USE ON FARM 1075/9 AND FARM 1070 PAARL DIVISION	15- 626
VOLUME 2		
5.2	APPLICATION FOR SUBDIVISION, CLOSURE OF PUBLIC PLACE, REZONING, CONSOLIDATION AND A DEPARTURE: ERF 1956, ERF 1957, UNREGISTERED ERF 6487 & UNREGISTERED ERF 6488, VICTORIA STREET, STELLENBOSCH	1 - 169
5.3	APPLICATION FOR THE REZONING AND SUBDIVISION OF ERF 579, FRANSCHHOEK	170 - 463
5.4	APPLICATION FOR REZONING AND SUBDIVISION AND SUBDIVISION ON FARM 742/2, PAARL DIVISION (LU/8787)	464 - 628
VOLUME 3		
5.5	APPLICATION FOR REZONING FROM AGRICULTURE TO LOCAL AUTHORITY FOR THE ESTABLISHMENT OF A PUBLIC CEMETERY AND MEMORIAL PARK ON A 70HA PORTION OF FARM NO. 502, STELLENBOSCH (LOUW'S BOS)	1 - 820
6.	OTHER MATTERS	

**MINUTES: STELLENBOSCH MUNICIPAL PLANNING TRIBUNAL 26 JUNE 2020**

**MINUTES OF THE STELLENBOSCH MUNICIPAL PLANNING TRIBUNAL MEETING  
HELD ON FRIDAY, 26<sup>TH</sup> OF JUNE 2020, via MS TEAMS 10H00-15H00**

**Ref. no. 3/4/5/2/40**

**2020-06-26**

Chairperson

Dr DJ Du Plessis

Deputy Chairperson

Ms C Havenga

External Members

Mr C Rabie

Dr R Pool-Stanvliet

Mrs H Crooijmans-Lemmer

Mr J Knight

Mr E Delpport

Internal Members

Mr B de la Bat: Manager Spatial Planning

Mr M Williams: Senior Legal Advisor

Mr S van der Merwe: Environmental Planner

Ms J Mowers- Senior Manager: Development, Asset Management and Systems & Project Management Unit -Infrastructure Services

Ms M Francis: Manager Project Management Unit

Mr G Cain: Manager IDP & Performance Management

Mr A van der Merwe: Senior Manager: Community Services

Technical Advisor

Mr K Munro: Director Development Management; Department of Environmental Affairs and Development Planning

Officials

Mr S Carstens: Senior Manager Development Management

Ms C Kriel: Manager Land Use Management

Ms L Guntz: Senior Town Planner

Mr R Fooy: Senior Town Planner

Mr P April: Senior Town Planner

Ms B Zondo: Senior Town Planner

Ms O Sims: Administrative Officer MPT

## MINUTES: STELLENBOSCH MUNICIPAL PLANNING TRIBUNAL 26 JUNE 2020

ITEM	SUBJECT
SMPT 01/06/20	<b>OPENING AND WELCOME</b>
	The Chairperson welcomed all present and extended a special word of welcome to Chrizelle Kriel and Anthony Barnes who joined the Stellenbosch Municipality on 1 June 2020.
SMPT 02/06/20	<b>LEAVE OF ABSENCE</b>
	Apologies were received from Mervin Williams who joined the meeting at 11:30 and Lenacia Kamineth.
SMPT 03/06/20	<b>DISCLOSURE OF INTERESTS</b>
	No conflicts of interest were noted.  Schalk van der Merwe noted his involvement in Item 5.4. He acted as a project administrator from the Stellenbosch Municipality. Albert van der Merwe also noted his involvement in the planning process of Item 5.4.
SMPT 04/06/20	<b>MINUTES OF THE PREVIOUS MEETINGS DATED 28 FEBRUARY 2020 FEBRUARY 2019</b>
	The Minutes of the previous meeting was approved.
SMPT 05/06/20	<b>MATTERS FOR CONSIDERATION</b>
	<p data-bbox="292 1592 1145 1621"><b>APPLICATION FOR SUBDIVISION, FARM NO. 1460/1 PAARL DIVISION</b></p> <p data-bbox="292 1668 456 1697"><b>DISCUSSION:</b></p> <p data-bbox="292 1704 1356 1771">Concerns were raised on the uncertainty of the proposed use of the portion to be subdivided off the farm, specifically the smaller Portion A.</p> <p data-bbox="292 1818 628 1848"><b>UNANIMOUSLY RESOLVED:</b></p> <p data-bbox="292 1895 1356 1995">1. <b>Approval not be granted</b> in terms of Section 60 of the Stellenbosch Municipal Land Use Planning By-Law, promulgated by notice number 354/2015 dated 20 October 2015, for:</p>

**MINUTES: STELLENBOSCH MUNICIPAL PLANNING TRIBUNAL 26 JUNE 2020**

	<p>1.1 Cancellation of unregistered subdivisional diagrams section 15 (2) (k) in respect of portions 81 and 82 of the Farm Deltameer No. 1460 Paarl Division.</p> <p>1.2 Subdivision in terms of section 15 (2) (d) of the Remainder of portion 1 of the Farm Deltameer No. 1460 Paarl Division into:</p> <ul style="list-style-type: none"> <li>• Portion A (± 1,25 hectares in extent)</li> <li>• Portion B (±11,58 hectares in extent)</li> <li>• The remainder Main Road No 191 (± 0.90 hectares in extent).</li> </ul> <p>1.3 Registration of servitudes over subdivided portions as indicated on Plan No.3 Rev 7 and dated Sept 2018-Jan 2019.</p> <p><b>REASONS FOR NON-APPROVAL:</b></p> <ol style="list-style-type: none"> <li>1. The application proposal provides no rationale of the intentions in subdividing the property and how it will contribute towards the development of the area.</li> <li>2. The application may compromise future development within the urban edge of the broader plan for the area.</li> <li>3. No indication was given as to how the subdivision will improve agricultural viability as stated on the application motivation.</li> <li>4. The proposed application does not motivate how it will fit in with the urban development as indicated in the MSDF.</li> <li>5. Recognised that the area is indicated within the urban edge, but the fragmentation of the land within its agricultural zoning is not supported.</li> </ol>
<p><b>SMPT</b> <b>06/06/20</b></p>	<p><b>REMOVAL OF A RESTRICTIVE TITLE DEED CONDITION, REZONING, SUBDIVISION, PHASING, STREET NAME AND NUMBERING AND DEPARTURES ON ERF 1692, FRANSCHHOEK</b></p> <p><b>DISCUSSION:</b></p> <ol style="list-style-type: none"> <li>a) A question was raised on the status of the land claim and it was confirmed that the land claim was resolved and that the claimants are participants in the proposed application. Portion 31 is reserved for the use by the claimants.</li> <li>b) Concerns were raised on the participation of the claimants in the process and it was confirmed that a resolution was signed by all the trustees of the Franschoek Claimant's Trust. <u>The power of attorney and resolution were emailed to the attendees during the meeting and are attached to the Minutes.</u> The potential defect of the Date and Place not indicated on the resolution is noted.</li> <li>c) Concerns were raised regarding the number of departures and limited size for the Private Open Space in the design. It was confirmed that the proposed layout is not inconsistent with the parameters in the Franschoek Zoning Scheme.</li> <li>d) Alternative proposals for layout, less hard surfaces and more open space may be investigated. It seems as if the open space is a buffer area and does not make spatial logical sense in the layout. It is noted that the</li> </ol>

design is not submitted for approval, and only the rezoning and subdivision of the property. A Site Development Plan needs to be submitted as a condition of approval. It was suggested that the possible reconfiguration of the units in the General Residential Components be investigated and that a proposal for a functional open space should be considered.

- e) Concerns raised on the size of the properties are noted. It is mentioned that the proposed property size conforms to other property sizes in the surrounding area. The proposal supports spatial transformation strategies such as the integration of communities and the creation of more affordable properties and is in line with the spatial proposals in the MSDF.
- f) Concerns were raised on the lack of assessment by the planner on NMT and parking requirements, the traffic impact, the natural state of the development and the biodiversity impact.
- g) Clarity is sought on the discrepancy of the proposed phasing of the development as indicated on page 142 between Phase 2 and Paragraph 6.5.

**UNANIMOUSLY RESOLVED:**

1. **Approval be granted** in terms of Section 60 of the Stellenbosch Municipal Land Use Planning By-Law, promulgated by notice number 354/2015 dated 20 October 2015, for:

- 1.1 The **removal of a restrictive title deed condition** in terms of Section 15(2)(f) of the said Bylaw of condition A.6 as contained in Title Deed Nr. T60152/2008 which reads *"that a general right of way from and to the adjoining Crown land over the whole of the land hereby granted is reserved in favour of the Government."*

- 1.2 The **rezoning** of the subject property from Undetermined Zone to Subdivisional Area in terms of Section 15(2)(a) of the said Bylaw to allow for the following uses (and in accordance with the land use framework plan and such phasing as depicted in plan with reference "Subdivision Plan/1692/02/1", dated May 2018 and "Phasing/1692/04/02", dated January 2019 November 2019, drawn by Headland Town Planners:

- a. Twenty-eight (28) Single Residential zone erven (portions 1- 28) and approximately 0,6061ha in extent for purposes of single dwelling units;
- b. Three (3) General Residential Zone erven (portions 29-31) and approximately 0,6630ha in extent, for apartment buildings;
- c. One (1) Business zone property (portion 32) and approximately 0,0908ha in extent, for office purposes;
- d. Three (3) Private Open Spaces erf (portions 33 and 34 and approximately 0,1321ha in extent for open space purposes and portion 35 approximately 0,5076 in extent for road purposes); and
- e. The phasing of the development into six (6) phases.

## MINUTES: STELLENBOSCH MUNICIPAL PLANNING TRIBUNAL 26 JUNE 2020

1.3 The **subdivision** in terms of Section 15(2)(d) of the said Bylaw in accordance with the subdivision plan "Subdivision Plan/1692/02/1", dated May 2018 and "Phasing/1692/04/02", dated January 2019 November 2019, drawn by Headland Town Planners.

1.4 **Departure** in terms of section 15(2)(b) of the said Bylaw:

a) Portion 29

- i. to exceed the permissible coverage from **25%** to **31%**;
- ii. to allow for a minimum street front of **13m** instead of **15m**;
- iii. to relax the common building lines (adjacent to Erf 2850 and Erf 2835, Franschoek) from **4,6m** to **3,0m** and **2,8m** respectively for building C;
- iv. to relax the common building line (adjacent to Erf 2835, Franschoek) from **4,6m** to **2,8m** and **3,1m** for building D;
- v. relax the common building line (adjacent to Erf 2835, Franschoek) from **4,6m** to **3,1m** and **3,3m** for building E;
- vi. relax the common building line (adjacent to Erf 2835, Franschoek) from **4,6m** to **3,0m** for building F.

b) Portion 30

- i. to exceed the permissible coverage from **25%** to **28%**;
- ii. from the provisions 8.3.5.1 of the Franschoek Zoning Scheme to permit a building to be constructed on a general residential site abutting a street with of **8,5m** in lieu of **12,5m**;
- iii. relax the street building line (Rue De Vie Street) from **7,6m** to **4,7m** and **3,9m** for building A;
- iv. relax the street building lines (Reservoir & Rue De Vie Streets) from **7,6m** to **4,7m** respectively for building B;
- v. relax the common building line (adjacent to Erf 1693, Franschoek) from **4,6m** to **3,8m** for building C;
- vi. **4,7m** in lieu of the **11,7m** from the street boundary of Rue De Vie for the portion that is less than 16m wide.

c) Portion 31

- i. to exceed the permissible coverage of **25%** to **37%**;
- ii. to exceed the permissible bulk of **0.4** to **0.74**;
- iii. from the provision 8.3.1 of the Franschoek Zoning Scheme Regulations to permit portion 31 to be **459m<sup>2</sup>** in lieu of **1000m<sup>2</sup>**;
- iv. from the provision 8.3.5.1 of the Franschoek Zoning Scheme Regulations to permit a building to be constructed on a general residential site abutting a street with a width of **8,5m** in lieu of **12,5m**;
- v. **7,0m** in lieu of **11,7m** from the Rue De Vie street boundary;
- vi. relax the common building line (adjacent to Portion 30) from **4,6m** to **3,3m**;
- vii. relax the common building line (adjacent to Portion 33) from **4,6m** to **2,1m**;
- viii. relax the common building line (adjacent to Erf 1693, Franschoek) from **4,6m** to **3,4m**.



**REASONS FOR APPROVAL:**

1. The proposal will develop underutilized land within the urban edge for urban development.
  2. The proposed residential development constitutes infill development and is therefore in line with the principles of the SDF.
  3. The scale and nature of the proposed development will not compromise the existing character of the surrounding landscape.
  4. Additional affordable residential opportunities will be made available within the area.
  5. The development will allow previously disadvantaged individuals of the Franschhoek Claimants Trust, to develop land that has been acquired through a land claim process.
  6. The proposed development will have a positive impact on the town's local economy as it will create new employment opportunities during the construction phase.
  7. The proposed business zone site allowing for general practitioners will not be out of character and will provide for the convenience of and service to the surrounding residential community.
  8. As the title restrictions are not for the benefit of any specific property or person, and the development parameters will still be governed by the applicable Zoning Scheme, the deletion of condition A.6 as contained in Title Deed Nr. T60152/2008 which reads "that a general right of way from and to the adjoining Crown land over the whole of the land hereby granted is reserved in favour of the Government will not negatively impact on the personal benefits of any surrounding property owner within this township development.
2. That the approval in Section 1 is **SUBJECT TO** the following conditions in terms of Section 66 of the said Bylaw:
- 2.1 The approval only applies to the proposed development in question, as indicated on attached **Subdivision Plan (Plan nr Subdivision/922/1 Revision 1, dated November 2019)** and the **Phasing Plan (Plan nr Phasing/922/1 Revision 1, dated November 2019)** and shall not be construed as authority to depart from any other legal prescriptions or requirements from Council.
  - 2.2 New erf diagrams or general plans for the newly created land units be submitted to the municipality for clearance and record purposes.
  - 2.3 The applicant submits an electronic copy (shp, dwg, dxf) of the General Plan which was preliminary approved by the SG. The following information must be indicated:
    - a) Newly allocated Erf Numbers
    - b) Co-ordinates
    - c) Survey Dimensions
    - d) Street names (if approved by Council).

- 2.4 All relevant owners' associations be established in terms of Section 29(1) of the said bylaw.
- 2.5 A constitution for each of the entities be submitted for approval to the Municipality and which constitution take into account the requirements stipulated in Section 29(3) of the said bylaw.
- 2.6 That the constitution for each of the relevant Owners Associations, inclusive of Architectural and Aesthetic guidelines, be submitted for approval by the Director: Planning and Economic Development and that the relevant Owners Associations comply with such requirements as may be imposed by these architectural and aesthetic guidelines;
- 2.7 That all public places and public streets be transferred to the Local Authority upon transfer of the first unit/erf in each phase of the subdivision. All cost for the surveying and transfer of public land will be for the account of the applicant/developer.
- 2.8 The existing municipal water line across Erf 1692, Franschoek be located in the road reserve of Rue de Vie Road and be protected by means of registration of a servitude to be undertaken by the developer at his cost prior to the vesting of the development rights.
- 2.9 All new servitude rights be registered in the title deeds of the applicable property/ies.
- 2.10 The conditions imposed by the **Director: Engineering Services** as contained in their memo dated 18 December 2019, attached as **ANNEXURE Q** be complied with.
- 2.11 The development contributions are payable before the transfer of the property or approval of building plans, whichever occurs first, and which amount will be calculated in accordance with the approved council tariffs in force at the time of payment.
- 2.12 A formal application be submitted for the erection of advertising signs and that all signage be in line with the signage policy of the municipality and be approved by the Municipality prior to any signage being erected.
- 2.13 A Site Development Plan be submitted for approval to the Directorate of Planning and Economic Development for portions 29, 30, 31 & 32 prior to the submission of any building plans.
- 2.14 The Site Development Plan referred to in paragraph 2.13 to adhere to spatial logic in the placement of buildings, clustering of parking and open space in a better revised configuration that will reduce the hard

## MINUTES: STELLENBOSCH MUNICIPAL PLANNING TRIBUNAL 26 JUNE 2020

	<p>surfaces and include more natural open space area.</p> <p>2.15 That Portion 32 be restricted for the exclusive use of medical consulting rooms (offices for general practitioners, specialists, etc) and with a gross leasable area of ±366m<sup>2</sup>.</p> <p>2.16 Landscape plan be developed in accordance with the revised Site Development plan and submitted to the Director: Community &amp; Protection Services.</p> <p>2.17 The approval not be acted upon prior to the issuing of a certificate of consolidated title and endorsement of the relevant title deed by the Registrar of Deeds.</p> <p>2.18 Consideration be given to the provision of Inclusionary housing units in order to expand housing opportunity for a broader range of income groups.</p> <p>2.19 Building plans only be submitted for approval when all conditions have been complied with.</p> <p>3. Matters on the application <b>TO BE NOTED:</b></p> <p>3.1 The approval on the name of the development and the naming and number of streets as per the proposed subdivision plan, with reference to <b>ANNEXURE C, BE OBTAINED</b> from the Executive Mayor of Stellenbosch as the duly authorised decision maker on such matters.</p> <p>3.2 The conditions stated in letter 16/3/3/1/B4/12/1067/18 by the Department of Environmental Affairs and Development Planning, dated 18 April 2018, <b>BE NOTED</b>. See <b>ANNEXURE I</b>.</p>
<p><b>SMPT</b> <b>07/06/20</b></p>	<p><b>APPLICATION FOR SUBDIVISION: ERF 721, PNIEL</b></p> <p><b>DISCUSSION:</b></p> <p>a) Clarity is sought on the zoning of the property. It is noted that the zoning is "Authority Use" in terms of the previous Zoning Scheme Regulations which is applicable as the application was submitted before the new Zoning Scheme Bylaw of 2019 came into effect. The zoning will be converted to "Utility Services" in terms of the Stellenbosch Zoning Scheme Bylaw.</p> <p>b) Concerns were raised as there is no access to the site and no provision made for parking but it was noted that parking requirements can be addressed on Portion A.</p> <p><b>UNANIMOUSLY RESOLVED:</b></p> <p>1. <b>Approval be granted</b> in terms of Section 60 of the Stellenbosch Municipal Land Use Planning By-Law, promulgated by notice number 354/2015 dated 20 October 2015, for:</p>

	<p>1.1 <b>Subdivision</b> of Erf 721, Pniel into two portions, Portion A (<math>\pm 2702 \text{ m}^2</math>) and Remainder (<math>\pm 5511 \text{ m}^2</math>).</p> <p><b>REASONS FOR APPROVAL:</b></p> <ol style="list-style-type: none"> <li>1. The proposal will not adversely impact on the surrounding environment, uses, property values or the character of the area.</li> <li>2. The zoning and land use will remain the same.</li> <li>3. The proposal will not have any impact on municipal services as no additional buildings or land use rights will be granted by the approval of the subdivision.</li> <li>4. Sufficient parking bays will still be provided to support the existing land uses.</li> <li>5. The proposed subdivision will only facilitate in the location of the existing Municipal building on a land unit with the remainder still being accessible to the public for road and parking purposes.</li> </ol> <p>2. The approval granted in Section 1 above, is <b>SUBJECT TO</b> the following conditions in terms of Section 66 of the said by-law:</p> <ol style="list-style-type: none"> <li>2.1 The subdivision diagram together with the Municipality's decision and conditions of approval be submitted to the Surveyor-General for approval within five (5) years from date of final notification.</li> <li>2.2 The application submits an electronic copy (shp, dwg, dxf) or A4 hard copy of the SG diagrams, which were preliminary approved by the SG. The following information must be indicated on the subdivision plan: <ol style="list-style-type: none"> <li>a) Newly allocated Erf Numbers</li> <li>b) Co-ordinates</li> <li>c) Survey Dimensions.</li> </ol> </li> <li>2.3 Raised kerbing be installed along the street boundary line of Portion 1 and Main Road No 172 and Hill Street to restrict direct access to the parking area located in front of the existing building from Main Road No 172 as required by the Department: Transport and Public Works, as contained in their letter dated 16 October 2017, attached here as <b>ANNEXURE G</b>.</li> <li>2.4 All servitudes applicable to Erf 721 be carried over to Remainder of Erf 721 to ensure that existing accesses are retained, and no portion of land is land locked by the proposal.</li> </ol>
<p>SMPT 08/06/20</p>	<p><b>REZONING FROM AGRICULTURAL ZONE 1 TO OPEN SPACE ZONE II FOR THE ESTABLISHMENT OF A PUBLIC CEMETERY AND MEMORIAL PARK: REMAINDER FARM NO. 29, STELLENBOSCH DIVISION</b></p> <p><b>DISCUSSION:</b></p> <ol style="list-style-type: none"> <li>a) Concerns were raised on the provision of sufficient parking for private vehicles. It was noted that access of private vehicles was taken into consideration when the layout was prepared, and provision is made for</li> </ol>

**MINUTES: STELLENBOSCH MUNICIPAL PLANNING TRIBUNAL 26 JUNE 2020**

parking throughout the cemetery development within the width of the roads and circular routes not to create bottlenecks.

- b) Clarity was sought on the number of burial opportunities and it was noted that provision is made for the next 30 years for between 30 000 and 35 000 burial opportunities to be created.
- c) Compliments were given to the project team leaders as well as the number of specialist studies which informed this development and the design proposal for of the cemetery and memorial park.
- d) Concerns were raised on the distance of the cemetery from town. It was noted that various sites were investigated and different criteria were considered.
- e) A question was raised on the compliance of health regulations and whether all approvals were obtained. It was noted that it will be followed up and compliance ensured.
- f) Questions were raised on the agricultural potential of the land, the biodiversity value, freshwater impact and surface run-off water. It was noted that the recommendation of specialist studies and comments were taken into consideration in the Environmental Authorization and addressed and informed the different zones in the layout of the development.

**UNANIMOUSLY RESOLVED:**

1. **Approval be granted** in terms of Section 60 of the Stellenbosch Municipal Land Use Planning By-Law, promulgated by notice number 354/2015 dated 20 October 2015, for:
  - 1.2 **Rezoning** of Remainder Farm No. 29, Stellenbosch Division from **Agricultural Zone I** to **Open Space Zone II** to allow for a public cemetery and memorial park.

**REASONS FOR APPROVAL:**

1. There is a great need for cemeteries in the Stellenbosch area.
  2. The property will be put to better use to provide a much needed social service to Stellenbosch Municipality and its inhabitants.
  3. The proposed rezoning will have limited affect on natural habitats, ecological corridors or high potential agricultural land and no viable agricultural land will be lost.
  4. The proposed development will optimise the use of existing resources and infrastructure.
2. The approval granted in Section 1 is **SUBJECT TO** the following conditions in terms of Section 66 of the said Bylaw:
    - 2.1 The approval applies only to the rezoning in question, and shall not be construed as authority to depart from any other legal prescriptions or requirements from Council.
    - 2.2 The neighbouring farms right to farm and that what is normally

associated with that (including boreholes, farm infrastructure and day to day farming activities but not limited to) be protected at all cost and that the cemetery and use thereof not impede in any way and that the owners/managers and successors in title agree to that.

2.3 The following conditions imposed by the **Manager: Spatial Planning** in their memo dated 14 November 2019, attached as **Annexure Q** be adhered to:

a) *The mitigation recommendation as contained in the visual impact assessment be implemented.*

b) *The mitigation measures contained in the Heritage Impact assessment be implemented.*

2.4 The following conditions imposed by the **Director: Engineering Services** in their memo dated 18 October 2019, attached as **ANNEXURE R** be adhered to:

a) *Wastewater and Sewage*

*A technical report by a suitable qualified professional, regarding the "package plant" proposed in your letter be submitted for approval, prior to the acceptance of any building plans, and prior to the installation thereof.*

b) *Water*

*The quality of the water for human use stored and distributed by the owner has to comply with SANS 241 Drinking Water Quality Standards. Current proof of compliance must be available on request.*

c) *Solid Waste*

*Solid waste be removed from the site to a lawful solid waste disposal site in accordance with the requirements of section 26 of the National Environmental Management Waste Act 2008 (Act 59 of 2008).*

d) *Roads*

*Prior to commencement of any demolition/construction work, a traffic accommodation plan for the surrounding roads be submitted to the Directorate: Infrastructure Services for approval.*

e) *Storm Water Management*

*The geometric design of the roads, parking area and grave layout ensures that no trapped low-points are created with regard to storm water management.*

2.5 A detailed landscaping and site development plan, indicating the details of the proposed land development be submitted to the Directorate of Planning and Economic Development for approval.

## MINUTES: STELLENBOSCH MUNICIPAL PLANNING TRIBUNAL 26 JUNE 2020

	<p>2.6 The approval will lapse if not implemented within the timeframe stipulated in the subject Bylaw.</p> <p>2.7 Building plans will only be approved when all conditions of approval have been complied with.</p> <p>2.8 The conditions stated in letter TPW/CFS/RP/LUD/REZ/SUB-25/342 by the <b>Department of Transport and Public Works</b> dated 15 November 2019, Paragraph 7, attached as <b>ANNEXURE K</b>, be adhered to.</p> <p>3. Matters on the application <b>TO BE NOTED:</b></p> <p>3.1 The conditions imposed by the <b>Department of Environmental Affairs and Development Planning</b> in their letter dated 20 September 2019 (Environmental Authorisation), attached as ANNEXURE G <b>BE NOTED</b>.</p> <p>3.2 The conditions stated in letter 20/9/2/5/6/904 by the <b>Department of Agriculture (Eisenburg)</b>, dated 17 January 2020, <b>BE NOTED</b>. See <b>ANNEXURE H</b>.</p> <p>3.3 The conditions stated in letter TPW/CFS/RP/LUD/REZ/SUB-25/342 by the <b>Department of Transport and Public Works</b> dated 15 November 2019, <b>BE NOTED</b>. See <b>ANNEXURE K</b>.</p> <p>3.4 A water use licence application (WULA) must be applied for and obtained prior to construction taking place.</p>
<p>SMPT 09/06/20</p>	<p><b>OTHER MATTERS</b></p> <p>The Meeting Adjourned at 14:52.</p>



Dr D du Plessis

**CHAIRPERSON: MUNICIPAL PLANNING TRIBUNAL**

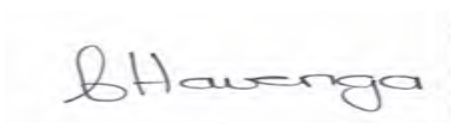

Mrs C Havenga

**DEPUTY CHAIRPERSON: MUNICIPAL PLANNING TRIBUNAL**

11.7	<b>PLANNING, LOCAL ECONOMIC DEVELOPMENT AND TOURISM: (PC: CLLR E GROENEWALD (MS))</b>
------	---

NONE

11.8	<b>RURAL MANAGEMENT: (PC: CLLR S PETERS)</b>
------	--

NONE

11.9	<b>YOUTH, SPORTS AND CULTURE: (PC: CLLR M PIETERSEN)</b>
------	--

11.9.1	<b>GUIDELINES ON THE IMPLEMENTATION OF THE CHILDREN'S ACT, ACT 38 OF 2005</b>
--------	---

**Collaborator No:** 695199  
**IDP KPA Ref No:** Dignified Living: Municipal Focus Area 21  
**File Plan:** 8/1/4/2/3  
**Meeting Date:** 17 November 2020 and 25 November 2020

**1. SUBJECT: GUIDELINES ON THE IMPLEMENTATION OF THE CHILDREN'S ACT, ACT 38 OF 2005**

**2. PURPOSE**

To obtain a formal position on the Guidelines for Municipalities on the Implementation of the Children's Act as introduced to municipalities on 14 August 2020 during a SALGA consultation process.

**3. DELEGATED AUTHORITY**

Council

**4. EXECUTIVE SUMMARY**

The Children's Act, 2005 (Act No. 38 of 2005) is the primary legislation that regulates protection and developmental services to children. Among others, it provides for the norms and standards linked to the registration, de-registration and monitoring of child care facilities.

It is 10 years since the Children's Act was implemented. The Department of Social Development (DSD) as the custodian of the Children's Act took an initiative and developed the guidelines for Municipalities to enhance implementation of some of the critical provisions in the Act, namely the assignment of functions to Municipalities.

The Guidelines aim to:

1. Guide both Provincial DSD and Municipalities on the implementation of the Children's Act;
2. Draw attention to the roles and responsibilities of Municipalities as part of Government in providing services to children; and



3. Assist both Provincial DSD and Municipalities with processes to assign functions in a uniform and coordinated manner.

Thus the Guidelines provide guidance in line with provisions of the Children's Act on: The functions in the Children's Act, which may be assigned to municipalities.

Secondly, to guide municipalities on their role to support and facilitate the implementation of the Act generally.

This item seeks to find agreement with the Guidelines in terms of process and interpretation of the Children's Act and the role of local government in the implementation of said Act.

## 5. RECOMMENDATIONS

- (a) that the municipality assists ECD's to comply with registration requirements;
- (b) that the municipality encourages ECD's to apply for Grant in Aid funding; and
- (c) that Stellenbosch Municipality does not accept the responsibilities as listed in the Guidelines as the municipality does not have the financial and/or human resource capacity to implement the guidelines.

## 6. DISCUSSION / CONTENTS

### 6.1 Background

Chapter 1, Section 4 of the Children's Act explicitly places an obligation on all spheres of government and organs of state to implement the Act to the maximum extent possible. This section states that;

*"(1) The Act must be implemented by organs of state in the national, provincial and, where applicable, local spheres of government subject to any specific section of the Act and regulations allocating roles and responsibilities, in an integrated, co-ordinated and uniform manner.*

*(2) Recognising that competing social and economic needs exist, organs of state in the national, provincial and where applicable, local spheres of government must, in the implementation of this Act, take reasonable measures to the maximum extent of their available resources to achieve the realisation of the objects of the Act."*

Section 5 of the Children's Act further requires all organs of state at the national, provincial and local level to work together within a uniform approach to coordinate and integrate services to children. This section states that:

*"To achieve the implementation of this Act in the manner referred to in section 4, all organs of state in the national, provincial and, where applicable, local spheres of government involved with the care, protection and well-being of children must co-operate in the development of a uniform approach aimed at co-ordinating and integrating the services delivered to children"*

Schedule 4B of the Constitution of the Republic of South Africa (1996) list "Child Care Facilities" as a local government matter to the extent set out in section 155(6) (a) and (7).

According to The National Guidelines for Municipalities on the Implementation of the Children's Act, the following are listed **as services that municipalities are obliged to provide (no need to be assigned)**, and have implications for the Children's Act:

1. Developing regulations.
2. Municipal planning, health services and public transport.

3. Providing structures for Child Care facilities.
4. Control of public nuisances and noise pollution.
5. Land allocation, zoning, roads and sport facilities.
6. Municipal parks and recreation.
7. Water, sanitation services and sewage disposal systems.
8. Refuse removal, refuse dumps and solid waste disposal.
9. Implementation provision of structural, Health and safety standards in Child and Youth Care Centres (CYCC), Early Childhood Development Centres (ECD), Partial Care Facilities (PCF) and Drop-in Centres (DIC) (Funeka – please explain what this refers to.) please see below
10. Powers of inspection for all the child care facilities

The following, however, **may be assigned by agreement** by either the HOD or the Municipal Manager:

1. Registration of facilities.
2. Assessment and Consideration of applications.
3. Renewal of registrations.
4. Conditional registration.
5. Cancellation of registration.
6. Issuing of notices of enforcement.
7. Maintaining records of facilities (database/profiles).
8. Monitoring of facilities.

The chapters that could be assigned are:

1. Chapter 5: Partial Care Facilities also known as crèches, day care centres for children from 0-9 years aimed to provide holistic development of a child;
2. Chapter 6: Early Childhood Development refers to the learning programme used at PCFs for the holistic development of children;
3. Chapter 13: Child and Youth Care Centres which is a detention centre for children under the age of 18 who are in need of care and also those who are involved in crime or awaiting trial; and
4. Chapter 14: Drop in centres - a facility which provides “basic services aimed at meeting the emotional, physical and social development needs of vulnerable children”. The basic services provided must include one of the following: food, homework support, laundry or personal hygiene—homework clubs and soup kitchens would count as drop-in centres.

The **process** of assigning functions as laid out in the guidelines is as follow:

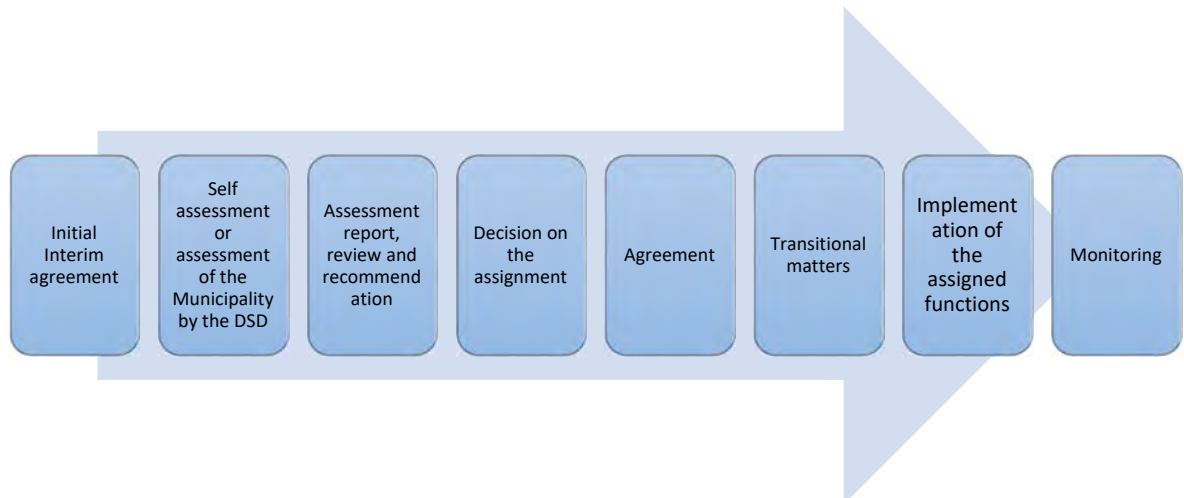

**Basic requirements** to consider with assignment of functions:

(i) Regulation 22(2) of Children's Act 38 of 2005 regarding:

- Skills, knowledge and qualifications of staff that will enable the municipality to implement the assigned function;
- Adequate staff to implement the assigned functions;
- Ability of the municipality, to develop capacity and monitor the implementation of the minimum norms and standards as it pertains to the assigned function.
- The overall capacity of the municipality to implement the assigned function.
- The financial ability of the municipality in terms of allocated funding to sustain these functions.

(ii) The willingness of the municipality at political and administrative level to manage and implement the assigned function.

(iii) The IDP of the municipality and how it facilitates the intended assignment of functions and the Annual Performance Plan (APP) of the municipal manager.

The guidelines contain the following on **norms and standards**:

*The norms and standards for partial care facilities and drop-in centres require these facilities to:*

- *Provide a safe environment for children including the structural safety of the building.*
- *Adequate space and ventilation.*
- *Safe drinking water.*
- *Hygienic and adequate toilet facilities.*
- *Access to refuse disposal services.*

*It is the primary duty of municipalities to provide water, sanitation, sewage disposal, refuse removal and building regulations.*

*Municipalities should therefore assist facilities to comply with the norms and standards in order to be registered.*

*In relation to partial care, the transport operators are required to possess the necessary permits and they should comply with the transport safety regulations.*

## **6.2 Discussion**

Child Care Facilities are listed in Schedule 4B of the Constitution of South Africa and cannot be ignored. To date exactly what is meant by the function has not been clarified. Is it the identification and servicing of land for the facilities or is it the building of facilities and the management thereof? The current municipal ECD Policy provides for the following responsibilities by the municipality:

1. **Land Use Management Department** is responsible for the affording of land use rights through zoning, re-zoning, temporary departures and consent use applications according to the Stellenbosch Municipal Zoning Scheme. Cost relating to these applications will be approved annually in the municipal tariffs with special dispensation for ECD applications.
2. **Building Control** is responsible for the approval of building plans, inspection of completed works and issuing of occupation certificates.

- 
3. **Community Development Department** is the lead department tasked with internal and external collaboration between all the role players and thus the driver of the municipal internal ECD committee. The department is also responsible for all approved ECD applications to be registered on the municipal GIS database for ECD centres and to provide support to the ECD sector and forums within the municipal area.

Further to the above, the Community Development Department is responsible:

- To ensure that the municipality aligns its services with the Children's Act in terms of registration and the Constitution in terms of the best interest of the child.
  - To ensure that we give the ECD sector support and partnership in terms of providing efficient services such as capacity building funding (Grant in Aid Funding) in order for them to provide efficient services within the Stellenbosch Municipal area.
  - To provide support to the local ECD forums in terms of sustainability and dissemination of information to all bodies that provide ECD services in the municipal area.
  - Parenting and family support programmes as envisaged through chapter 8 of The Act and the White Paper on Families (2012).
4. The **Property Management Department** is responsible for identification of possible land or underutilized facilities for ECD centres. The department, in consultation with Legal Services, is responsible to sign lease or facility management agreements between Stellenbosch Municipality and appointed registered ECD NGOs that operate from Council owned facilities. The department can take responsibility for ECD infrastructure development on identified land or at existing municipal facilities.
5. The **New Housing Department** is responsible to ensure that no new housing development projects are approved without provisioning for suitable ECD service delivery.
6. **Environment, Sport and Facilities Department** is responsible for the identification of new parks and the linkage between ECD locations and new and existing parks. Community parks in close approximation of ECD centres must receive priority attention regarding upgrading and maintenance. The department is also responsible to make community facilities available for implementation of children's activities such as the "come and play" programme. This will be done by implementing a fair tariff structure to recognise community based ECD centres and facilities. Community facilities which can also be used to implement ECD capacity building training sessions should be made available for this purpose. Where possible, underutilized community facilities can be made available for the establishment of ECD centres after consultation with the community and in an open and fair tender process.
7. **Library Services** is responsible for the provision of well-resourced child-friendly libraries. A library service should investigate collaboration with specialized toy library services if they cannot operate a toy library services by themselves. Further support to ECD centres include holiday programmes, active reading and story-telling programmes as well as availing library halls to ECD centres for activities.

- 
8. **Fire and Emergency Services** assess the ECD facility for its compliance with the national fire regulation and issues fire safety certificates. The department will be represented on the municipal internal ECD committee. Educational programmes for ECD centres on fire prevention will be conducted by the department.
  9. **Environment, Sport and Facilities Department** is responsible for the identification of new parks and the linkage between ECD locations and new and existing parks. Community parks in close approximation of ECD centres must receive priority attention regarding upgrading and maintenance. The department is also responsible to make community facilities available for implementation of children's activities such as the "come and play" programme. This will be done by implementing a fair tariff structure to recognise community based ECD centres and facilities. Community facilities which can also be used to implement ECD capacity building training sessions should be made available for this purpose. Where possible underutilized community facilities can be made available for the establishment of ECD centres after consultation with the community and in an open and fair tender process.
  10. **Disaster Management** will implement an educational programme aimed at prevention of disasters at ECD centres.
  11. **Traffic Services** will conduct road safety education programmes at ECD centres. Centres in areas with high traffic volumes during the times when children are dropped off or picked up from the centre can apply for traffic calming measures to be implemented at their schools as well as point duty officers during peak times.
  12. **Infrastructure Services** (Electricity, Water, Sewage) in formal areas:
    - **Water and Sewerage:** Stellenbosch Municipality supplies potable water to the entire municipal area through existing bulk water infrastructure consisting of Water Treatment Plants, Reservoirs and bulk and network water distribution systems. Sewerage is being collected through a collector pipe network and outfall sewer system to be treated at various treatment works throughout Stellenbosch area. Water and Sewer Future plans and Master Plans are kept up to date to enable SM to plan, budget and implement enhancements to the existing infrastructure. All the formal households in the urban areas of Stellenbosch Municipality's Management Area are provided with water connections and waterborne sanitation facilities inside the houses (higher level of service).
    - **Electrical Services:** Stellenbosch municipality is responsible for the provision of electricity within the WCO24. However there are few areas within the WCO24 that are Eskom or Drakenstein areas of supply. These areas are: Wemmershoek, Pniel, James Town, Vlottenburg, Raithby, La Motte, Groendal, Klappmuts and Koelenhof.
  13. **Finance Services: Income and Expenditure Department:** is responsible for availing budget for the development of ECD centres and play parks. Aligning ECD centres with their internal policies for any special tariffs and manage payments for leases of municipal property.

The Children's Act (38 of 2005) as enacted in 2010 is clear that all spheres of government has a role to play in the development and protection of children. The interpretation of "*and, where applicable, local spheres of government*", requires further consultation and legal input including input, from SALGA.

The Guidelines are not clear on what is required in terms of the identified norms and standards. The suitability and accuracy of said guidelines can thus not be agreed upon.

The guidelines were also developed without consultation, and were provided to municipalities on 14 August 2020 with the instruction to provide agreement per municipality on the content thereof by the middle of October 2020.

It is difficult not to be left with a feeling of trepidation considering the financial impact and risk should a child be hurt at a facility under the “care” of a municipality when considering the proposed guidelines. The impression is created that legislation is interpreted in a way that will make municipalities responsible for functions that are not necessarily that of local government, without anywhere clearly stating that the primary responsible department for the function (DSD) will take financial and/or legal responsibility for the function and the staff component required to fulfil the function for as long as local government fulfil said function or portion thereof.

As the guidelines come down to the interpretation of the Act, the department is of the view that legal opinion should be requested, including from SALGA, as the guidelines affect all municipalities within South Africa.

### **6.3 Financial Implications**

Assuming functions in relation to the registration, de-registration and monitoring of child care facilities will have major financial implications on the municipality. The financial implications will include the following:

1. Skills Development for existing staff
2. Appointment of suitably qualified and registered social workers, social auxiliary workers and ECD assistants
3. Additional office space and transport

### **6.4 Legal Implications**

Urgent input is required from our legal department in relation to the interpretation of the roles and responsibilities as it appears in the Act and the Guidelines.

### **6.5 Staff Implications**

Assigning the functions as illustrated through the Children’s Act Implementation Guide for Municipalities will have serious staff implications for the municipality. The extent of the impact is not clear as the guidelines do not indicate how many staff members at what qualification level are required per facility with a specific capacity.

### **6.6 Previous / Relevant Council Resolutions**

Approval of the Stellenbosch Municipal ECD Policy which does not make provision for the registration and monitoring of child care facilities as a function of local government.

### **6.7 Risk Implications**

Registration and monitoring of facilities do not necessarily mean the management of a facility which can still be done by private individuals and/or NGO’s. Should a child however be neglected, abused or gravely injured at such a facility, the municipality will be held liable as the overseeing agency.

### **6.8 Comments from Senior Management**

#### **6.8.1 Director: Infrastructure Services**

Agree with the recommendations.

**6.8.2 Director: Planning and Economic Development**

Agree with the recommendations.

**6.8.3 Director: Community and Protection Services**

Agree with the recommendations.

**6.8.4 Director: Corporate Services**

Agree with the recommendations.

**6.8.5 Chief Financial Officer:**

Agree with the recommendations.

**6.8.6 Municipal Manager:**

Agree with the recommendations.

**RECOMMENDATIONS FROM THE YOUTH, SPORTS AND CULTURE COMMITTEE TO THE EXECUTIVE MAYOR: 2020-11-05: ITEM 5.1.1**

- (a) that the municipality assists ECD's to comply with registration requirements;
- (b) that the municipality encourages ECD's to apply for Grant in Aid funding; and
- (c) that Stellenbosch Municipality does not accept the responsibilities as listed in the Guidelines as the municipality does not have the financial and/or human resource capacity to implement the guidelines.

**RECOMMENDATIONS FROM THE EXECUTIVE MAYOR, IN CONSULTATION WITH THE EXECUTIVE MAYORAL COMMITTEE, TO COUNCIL: 2020-11-17: ITEM 7.9.1**

- (a) that the municipality assists ECD's to comply with registration requirements;
- (b) that the municipality encourages ECD's to apply for Grant in Aid funding; and
- (c) that Stellenbosch Municipality does not accept the responsibilities as listed in the Guidelines as the municipality does not have the financial and/or human resource capacity to implement the guidelines.

**ANNEXURES**

**Annexure A:** Municipal Guidelines on the Implementation of the Children's Act.

**Annexure B:** Children's Act (38 of 2005)

**FOR FURTHER DETAILS CONTACT:**

<b>NAME</b>	Michelle Aalbers
<b>POSITION</b>	Manager Community Development
<b>DIRECTORATE</b>	Community and Protection Services
<b>CONTACT NUMBERS</b>	8408
<b>E-MAIL ADDRESS</b>	Michelle.aalbers@stellenbosch.gov.za
<b>REPORT DATE</b>	18-08-2020

# **ANNEXURE A**



# GUIDELINES FOR MUNICIPALITIES ON THE IMPLEMENTATION OF THE CHILDREN'S ACT

2019

## TABLE OF CONTENTS

ACRONYMS .....	4
DEFINITIONS .....	4
1. SUMMARY .....	6
2. INTRODUCTION .....	7
3. BACKGROUND .....	8
4. PURPOSE .....	10
5. RATIONALE FOR THE GUIDELINES .....	10
6. GUIDING PRINCIPLES .....	11
7. MUNICIPALITIES AS KEY DELIVERY SITES OF SERVICES TO CHILDREN .....	12
8. MUNICIPAL BY-LAWS .....	13
9. LEGAL REQUIREMENTS .....	14
7. ASSIGNMENT OF FUNCTIONS IN TERMS OF THE CHILDREN'S ACT .....	15
7.1. Assignable functions in terms of section 88, section 102 and section 225 of the Children's Act .....	15
7.2. The process of assignment of functions to municipalities .....	17
7.2.1. Assignment of functions initiated by the provincial Department of Social Development .....	18
7.2.2. Assignment initiated by municipality .....	19
7.3. Interim agreement between the provincial Department of Social Development and a municipality .....	20
7.4. Basic Requirements for the assignment of functions to municipalities .....	21
7.5. Assessment of a municipality by the provincial Department of Social Development .....	22
7.6. Assessment report, review and recommendation .....	25
7.7. Decision on the assignment of functions by the HOD .....	26
7.8. Agreement between the provincial Department of Social Development and a municipality on the assignment of functions .....	27
7.9. Transitional arrangements .....	28
7.10. Implementation of the assigned functions by the municipality .....	29
7.11. Monitoring and review by the provincial Department of Social Development .....	30

7.12. Amendment of agreement to the assigned functions ..... 30

7.13. Withdrawal of the agreement on the assignment of functions ..... 31

7.14. Procedures for the delegations by the municipal manager ..... 31

8. GUIDELINES FOR MUNICIPALITIES TO SUPPORT AND FACILITATE THE IMPLEMENTATION OF THE CHILDREN’S ACT ..... 32

8.1. Play and recreation ..... 32

8.2. Services for children with disabilities ..... 32

8.3. Provision of health services ..... 33

8.4. Provision of childcare facilities ..... 34

8.5. Child Protection Services ..... 34

8.6. Prevention and early intervention services ..... 35

8.7. Services to vulnerable children ..... 35

8.8. Places of entertainment for children ..... 36

8.9. Norms and standards ..... 36

9. MUNICIPAL BY-LAWS IN RELATIONS TO THE ACT ..... 37

10. ROLES AND RESPONSIBILITIES ..... 37

ANNEXURE A: AGRREMENT FORM ..... 51

ANNEXURE B: FORM 22 ..... 54

ANNEXURE C: FORM 29 ..... 65

ANNEXURE D: FORM 30 ..... 69

**ACRONYMS**

APP	Annual Performance Plan
DSD	Department of Social Development
ECD	Early Childhood Development
HOD	Head of Department
IDP	Integrated Development Plan
M&E	Monitoring & Evaluation
MEC	Member of the Executive Committee
NDP	National Development Plan
PEI	Prevention and Early Intervention
SAC	South African Constitution

**DEFINITIONS**

“by-law” means legislation passed by the council of a municipality binding the municipality and the persons to whom it applies.

“child” means a person under the age of 18 years.

“executive authority”, in relation to a municipality, means the municipality’s executive authority envisaged in section 156 of the Constitution read with section 11 of the Municipal Systems Act No. 32 of 2000.

“financially sustainable”, in relation to the provision of a municipal service, means the provision of a municipal service in a manner aimed at ensuring that the financing of that service from internal and external sources, including budgeted income, grants and subsidies for the service, is sufficient to cover the costs of—

- (a) the initial capital expenditure required for the service;
- (b) operating the service; and
- (c) maintaining, repairing and replacing the physical assets used in the provision

of the service;

“municipal manager” means a person appointed in terms of section 82 of the Municipal Structures Act;

“Municipality”, when referred to as— an entity, means a municipality as described in section 2 of the Municipal Systems Act No. 32 of 2000; and a geographic area. means a municipal area determined in terms of the Local Government: Municipal Demarcation Act, 1998 (Act No. 27 of 1998);

“basic municipal services” means a municipal service that is necessary to ensure an acceptable and reasonable quality of life and, if not provided, would endanger public health or safety or the environment;

## 1. SUMMARY

The Children’s Act, 2005 (Act No. 38 of 2005) is the primary legislation that regulates protection and developmental services to children. For local government, it identifies partial care, early childhood development and drop-in centres as facilities and programmes that can be assigned to municipalities, provided that the provincial head of social development (HOD) is satisfied that municipality complies with the prescribed requirements with regard to the capacity of that municipality to perform the functions concerned. The Act also sets out norms and standards which early childhood development (ECD) services, partial care centres and drop-centres should comply with. It gives the Department of Social Development (DSD) the responsibility for registration of these programmes and facilities based on their compliance with standards. It also recognises the multisectoral approach to the protection of children, as well as the role of other departments such as Education, Finance, Health, Cooperative Governance, as well as Transport in the delivery services to children.

The Act extensively provides for the protection of all children from abuse, neglect, exploitation and unnecessary removal of children from their families. It obliges, among others, members of staff and volunteers at child care and protection facilities to report abuse to the police, a designated child protection organisation or provincial Department of Social Development. Further protection for children is provided for through the National Child Protection Register, which keeps a record of persons unsuitable to work with children and children who are victims of abuse and neglect. The Act requires that persons whose names appear in Part B of the National Child Protection Register are persons not suitable to work with children. People working with children and those in regular contact with children will have to be screened for their suitability to work with children. These include staff members and volunteers in children’s programmes as well as other officials and sectors involved in the implementation of the Act.

Functions which, in terms of the Children's Act, reside with municipalities without any need for assignment or delegation are the implementation of structural, health and safety standards in child and youth care centres, ECD facilities, partial care facilities and drop-in centres, and powers of inspection with regard to all children's facilities. Municipalities are also responsible for zoning and land allocation to such facilities as well as providing a range of municipality services.

## 2. INTRODUCTION

In the context of an ongoing economic crisis, high levels of unemployment and inequality South Africa is experiencing, many families are under material and psychological pressure to make ends meet. Communities can no longer provide the same level of support to families and a safe environment for children as before without adequate support. Under these conditions, some children are at even greater risk of vulnerability, underdevelopment, abandonment, abuse, neglect and exploitation. One of the ways to mitigate such vulnerability is to create Child Friendly Communities (CFCs). The Child Friendly Communities Initiative has been adopted in various parts of the world to support children, families and their communities to safeguard children's rights and wellbeing in the neighborhoods where they live. A child friendly community can be defined as *"any local system of governance, urban or rural, large or small, committed to fulfilling children's rights. It is a community where the needs, rights, priorities and voices of children are an integral part of policies, budgets, programmes and decisions. It is also a community that actively and consciously acts towards the realization of all children's rights by coordinating the efforts of all social systems and agencies, targeting major areas of a child's life, such as health, education, safety, housing and participation using an intersectoral approach"*.<sup>1</sup>

<sup>1</sup> Department of Social Development (2015). *Safe and Caring Communities: Strengthening Local Governance for Children: A child Friendly Communities Framework*. Pretoria

This Framework consists of Nine Building Blocks that are necessary to "build" a child friendly community. Through these building blocks communities will be able to:

- i. Create platforms for children to participate and influence community decisions and actions.
- ii. Base community decisions on a child-friendly legal framework.
- iii. Develop an inclusive community-wide children's rights strategy.
- iv. Create and utilize children's rights coordinating mechanisms.
- v. Empower children to assess their communities and community resources.
- vi. Promote, develop and implement child friendly budgets.
- vii. Produce a regular state of the community's children's report.
- viii. Make children's rights known by children and adults.
- ix. Support independent advocacy for children.

The Children's Act makes provision for municipalities to carry out their responsibilities to the benefit of children. It also seeks to realise some of the Building Blocks for child friendly communities. Lastly it defines how municipalities could create a child friendly environment as their contribution to the protection of children.

## 3. BACKGROUND

The Children's Act, seeks to afford children the necessary care, protection and assistance so that they can develop to their full potential. It gives effect to international and national obligations that the country has agreed to deliver on, as provided for in the:

- a. United Nations Convention on the Rights of the Child;
- b. African Charter on the Rights and Welfare of the Child and its Optional Protocols;
- c. Hague Convention on Protection of Children and Co-operation in respect of Inter-country Adoptions;
- d. Hague Convention on the Civil Aspects of International Child Abduction;

- e. Convention concerning the Prohibition and Immediate Action for the Elimination of the Worst Forms of Child Labour, amongst others, as well as
- f. The South African Constitution.

All of the aforementioned place an obligation on the national, provincial and local spheres of government to promote, protect and fulfil the rights of children.

Section 4 of the Children's Act explicitly place an obligation on all spheres of government and organs of state to implement the Act to the maximum extent possible.

This section states that;

*“(1) The Act must be implemented by organs of state in the national, provincial and, where applicable, local spheres of government subject to any specific section of the Act and regulations allocating roles and responsibilities, in an integrated, co-ordinated and uniform manner.*

*“(2) Recognising that competing social and economic needs exist, organs of state in the national, provincial and where applicable, local spheres of government must, in the implementation of this Act, take reasonable measures to the maximum extent of their available resources to achieve the realisation of the objects of the Act.”*

Section 5 of the Children's Act further requires all organs of state at the national, provincial and local level to work together within a uniform approach to coordinate and integrate services to children. This section states that:

*“To achieve the implementation of this Act in the manner referred to in section 4, all organs of state in the national, provincial and, where applicable, local spheres of government involved with the care, protection and well-being of children must co-operate in the development of a uniform approach aimed at co-ordinating and integrating the services delivered to children”*

Thus, the State at the national, provincial and local level has a general responsibility to implement the Children's Act, but also have specific responsibilities that are explicitly assigned within the Act. These responsibilities can either be assigned directly, for example, powers conferred to the provincial Head of Social Development (HOD). The Act also makes provision for assignment of certain functions through agreement between a provincial HOD and a municipality. Functions that may be assigned relate to partial care, early childhood development and/or drop-in centres.

#### 4. PURPOSE

This Document aims to provide essential information and guidance to provincial Departments of Social Development and municipalities on the implementation of the Children's Act, and to draw attention to the roles and responsibilities of municipalities as part of the Government, to provide services to children. The focus is primarily on the provisions of the Children's Act.

The Department of Social Development (DSD) as the principal stakeholder in the implementation of the Children's Act, deemed it appropriate and necessary to issue national guidelines to ensure uniform, consistent and coordinated application of the provisions of the Act in all provinces and municipalities.

This Document spells out the minimum **generic** requirements that will facilitate the assignment of certain functions in the Children's Act to municipalities and to guide municipalities on their roles and responsibilities to facilitate the implementation of the Act.

#### 5. RATIONALE FOR THE GUIDELINES

One of the key requirements of the Children's Act, as mentioned above, is the assignment of functions to municipalities in a legally prescribed manner. Since the promulgation of the Act, it is noted that no functions have been assigned to

municipalities for partial care, early childhood development (ECD) programmes and drop-in centres as provided for in the Act. Neither does a uniform and coordinated framework or guideline for this exist.

The purpose of this document is to provide guidelines in line with provisions of the Children's Act on:

- The functions in the Children's Act, which may be assigned to municipalities.
- Secondly, to guide municipalities on their role to support and facilitate the implementation of the Act generally.

## 6. GUIDING PRINCIPLES

The guiding principles for this document derive from the provisions of the Children's Act itself in combination with the rights of the child as provided for in the South African Constitution (SAC).

- The **Best interests of the child** as safeguarded in section 28(2) of the South African Constitution and repeated in section 7 of the Children's Act.
- **Child-centred:** The system must be designed around, and in response to, the needs, rights and vulnerabilities of children.
- **Recognition of and respect for parents and families as primary duty-bearers of care and protection:** Parents and families are the primary duty-bearers for the provision of care to ensure the development and protection of their children; the system must prioritise maximising their capacity to do so.
- **Equity, non-discrimination and social inclusion:** This Document is founded on the universality of children's rights to survive, be protected from abuse and neglect, and develop to their full potential. This means that no children may be excluded from access to any of the child care and protection services provided for in legislation based on any of the constitutionally prohibited grounds, including race, gender, sex, ethnic or social origin, sexual orientation, age, disability, religion, conscience, language, culture or birth.

- The *distinctive, interdependent and interrelated nature* of the national, provincial and local spheres of government. (SAC Section 40(1))
- The *principles of co-operative and intergovernmental relations* that are based on mutual trust and good faith. (SAC Section 41)
- The *collaborative implementation of the Children's Act in an integrated, co-ordinated and uniform manner*. (Children's Act Section 4(1))
- *Reasonable measures to the maximum extent within the resources available to realise the objects of the Children's Act*. (Children's Act Section 4(2))
- *A uniform approach in coordinating and integrating services for the care, protection and well-being of children*. (Children's Act Section 5)

## 7. MUNICIPALITIES AS KEY DELIVERY SITES OF SERVICES TO CHILDREN

Poverty is a key development challenge in social, economic and political terms; not only in South Africa but throughout the developing world. In post-apartheid South Africa, fighting poverty and under-development has always been a central theme of Government. This is cemented in the in the National Development Plan (NDP) published in 2011. The guiding objectives of the NDP is the elimination of poverty and the reduction in inequality and all the elements of the plan must demonstrate their effect on these two objectives.

Given the fact that South Africa experiences high levels of poverty, unemployment and inequality. Municipalities are directly confronted with the day to day community challenges. As a result, a large part of the burden of addressing social challenges falls upon local government, as it is the provider of primary services, which are essential to the dignity of all who live in their area of jurisdiction.

Thus, local government is and remains the key site of delivery and development, and is central to the entire transformative project of the country. It is therefore a key mandate of local government (with the support of provincial and national government) to tackle the disparities and day to day challenges that face the country, especially with regard its children.

Many municipalities have already taken on work that relates to the care, protection and well-being of children as part of their mandate. This includes providing services to indigent households, the provisioning of safe water, provision and maintenance of recreational facilities for children (e.g. parks, swimming pools, and sports facilities), libraries, housing, sanitation, and health care services, amongst others.

Many municipalities draw up profiles on their wards (communities) that include specific issues pertaining to children. For example, they provide support and services to children living and working on the streets, children with disabilities, child headed households, set safety and health standards for facilities (partial care, entertainment centres, etc.) that take care of children. Some of these services are provided in terms of municipal policies and bylaws, municipal council resolutions or related provisions that guide and regulate operations at municipal level.

## 8. MUNICIPAL BY-LAWS

A number of municipalities have by-laws that have a direct bearing on the care, protection and well-being of children, such as by-laws on child care; by-laws on the use of recreational facilities such as swimming pools; by-laws on libraries; and so forth. These by-laws often differ significantly in standard and provision from municipality to municipality, and are not uniform. Thus, different standards are often set for services that relate to children in different municipalities, and some may not meet national requirements or the measures set out in the Children's Act.

In respect of bylaws, the Children's Act in section 3 provides that:

*"In the event of a conflict between a section of this Act and.... (1)(b) "... a municipal by-law relating to the protection and well-being of children, the conflict must be resolved in terms of section 156 of the Constitution".*

*(2) In the event of a conflict between a regulation made in terms of this Act and ... (c) a municipality by-law, the conflict must be resolved in terms of section 156 of the Constitution",*

Section 156(3) of the Constitution indicates that *"a by-law that conflicts with national or provincial legislation is invalid"*. Thus, municipal by-laws should be in line (and not in conflict) with the Children's Act.

Regarding the assignment of functions, section 156 of the Constitution provides for assignment of functions by national government or provincial government to a municipality. The assignment must be by agreement and may be subject to some conditions. The assignment should be for matters that would most effectively be administered locally and the municipality must have the capacity to administer it.

## 9. LEGAL REQUIREMENTS

The process of assigning functions to municipalities is regulated by the Constitution, the Children's Act 38 of 2005, the Local Government: Municipal Systems Act 32 of 2005 and the Financial and Fiscal Commission Act 99 of 1997 (as amended).

Section 3 (2A) of the Financial and Fiscal Commission Act 99 of 1997 as amended states that:

*"an organ of state in one sphere of government which seeks to assign a power or function to an organ of state in another sphere of government in terms of a law must first, before assigning the power or function-*

*(i) notify the Commission of the fiscal and financial implications of such assignment on-*

*(aa) the future division of revenue raised nationally between the spheres of government as required by section 214 of the Constitution;*

*(bb) in the case of an assignment to a provincial or local organ of state, the fiscal power, fiscal capacity and efficiency of the relevant province or municipality; and*

*(cc) any transfer of employees, assets and liabilities, if any; and*

*(ii) request the recommendation or advice of the Commission regarding such assignment.”*

According to section 10 (3) of the Local Government: Municipal Systems Act 32 of 2005, the Cabinet member or MEC initiating an agreement for assignment of functions to a municipality, must take appropriate steps to ensure sufficient funding, and capacity building initiatives as may be needed, for the performance of the assigned function or power by the municipality concerned if—

*(a) the assignment of the function or power imposes a duty on the municipality concerned;*

*(b) that duty falls outside the functional areas listed in Part B of Schedule 4 or Part B of Schedule 5 to the Constitution or is not incidental to any of those functional areas; and*

*(c) the performance of that duty has financial implications for the municipality concerned.*

## **7. ASSIGNMENT OF FUNCTIONS IN TERMS OF THE CHILDREN’S ACT**

### **7.1. Assignable functions in terms of section 88, section 102 and section 225 of the Children’s Act**

*(a) The Children Act provides in sections 88(1), 102(1) and 225(1), for the assignment of functions in relation to partial care, early childhood development and drop-in-centres respectively.*

Section 88 (1) outlines functions that may be assigned in relation to partial care. This section states that

*“ The provincial head of social development may, by written agreement with a municipality, assign the performance of some or all of the functions*

*contemplated in sections 80, 81, 82, 83, 84, 85 and 87 to the municipal manager if the provincial head of social development is satisfied that the municipality complies with the prescribed requirements with regard to the capacity of that municipality to perform the functions concerned”.*

These section relate to the:

- i. registration of facilities (S80),
- ii. assessment and consideration of applications (S81 and S82),
- iii. renewal of registration (S81),
- iv. conditional registration of facilities (S83),
- v. cancellation of registration (S84),
- vi. issuing of notices of enforcement (S85), and
- vii. maintaining records of partial care facilities and conducting inspections in partial care facilities (S87).

Section 102 (1) regulates functions that may be assigned to municipalities in relation to ECD services. According to this section,

*“The provincial head of social development may, by written agreement with a municipality, assign the performance of some or all of the functions contemplated in sections 95, 96, 97, 98, 99 and 100 to the municipal manager if the provincial head of social development is satisfied that the municipality complies with the prescribed requirements with regard to the capacity of that municipality to perform the functions concerned”.*

These sections focus on:

- i. registration of ECD programmes (S95),
- ii. assessment and consideration of applications (S96 and S97),
- iii. renewal of registration (S96),
- iv. conditional registration of programmes (S98),
- v. cancellation of registration (S99) and
- vi. issuing of notices of enforcement (S100).



Section 225(1) provides for the assignment of functions relating to drop-in centres. It states that,

*“The provincial head of social development may, by written agreement with a municipality, assign the performance of some or all of the functions contemplated in sections 217, 218, 219, 220, 221, 222 and 224 to the municipal manager if the provincial head of social development is satisfied that the municipality complies with the prescribed requirements with regard to the capacity of that municipality to perform the functions concerned”.*

These sections are similar to the provisions for partial care and ECD. They focus on:

- i. registration of drop-in centres,
- ii. assessment and consideration of applications,
- iii. renewal of registration,
- iv. conditional registration,
- v. cancellation of registration and
- vi. issuing of notices of enforcement.”

(b) The assignment of these functions must be in writing and in Annexure A of this Document.

## **7.2. The process of assignment of functions to municipalities.**

- (a) The assignment of the functions can be either
- by way of a request from the provincial Department of Social Development to a specific municipality; or
  - by way of a request from a municipality to a provincial Department of Social Development.

(b) Though the initiation of the request for the assignment of the functions may differ and require different actions, the core process of the assignment of functions will remain the same as this Document will indicate.

### **7.2.1. Assignment of functions initiated by the provincial Department of Social Development**

(a) The HOD, in consultation with MEC for Social Development, within the parameters of the provincial strategy for partial care and/or early childhood development and/or drop-in centres as contemplated in section 77(2) (b), section 92(2) (b) and section 214(2) (b) of the Children’s Act, respectively, may identify specific municipalities to which the functions as identified above may be assigned.

(b) The assignment of functions, shall take due consideration of aspects such as accessibility of services, effective service delivery and efficient use of resources.

(c) The HOD shall engage in bilateral discussions with the identified municipality to get an in-principle interim agreement on;

- willingness of the municipality to accept the possible assignment of functions;
- the procedures that will be followed;
- the timeframe attached to the process of the possible assignment of functions;
- an understanding that the assignment is subject to the municipality complying with minimum requirements with regard to capacity and the necessary funding to perform the functions set to be assigned as contemplated in sections 88(1), 102(1) or 225(1) of the Children’s Act, respectively.

(d) The HOD shall:

- Make the prescribed requirements known to the municipality.
- Establish a written interim agreement with the municipality that spells out the process, procedures, timeframes and roles and responsibilities of both parties.

### 7.2.2. Assignment initiated by municipality

(a) The municipal manager, in consultation with the Mayor and the Municipal Council, within the parameters of the Integrated Development Plan (IDP) of the municipality, may decide that the municipality has the capacity and funding as contemplated in sections 88(1), 102(1) or 225(1) of the Children's Act, respectively, and wish to have those functions for partial care and/or early childhood development and/or drop-in centres, assigned to it.

(b) The municipal manager shall engage in bilateral discussions with the HOD to indicate:

- The municipality's willingness to have functions assigned to it;
- That the municipality believes it has the capacity and funding to perform the functions set to be assigned as contemplated in sections 88(1), 102(1) or 225(1) of the Children's Act, respectively.
- The municipality's willingness to enter into a process of assessment by the provincial Department of Social Development to confirm its capacity, financial ability and readiness to have functions assigned to it.

(c) The HOD, in consultation with MEC for Social Development, shall consider the request by the municipality for the assignment of functions giving due consideration to the provincial strategy for partial care and/or early childhood development and/or drop-in centres as contemplated in section 77(2) (b), section 92(2) (b) and section 214(2) (b) of the Children's Act, respectively.

(d) The HOD shall:

- Inform the municipality of the decision of the provincial Department of Social Development to consider the municipality's request for the assignment of functions with 30 days after such a request was made;
- Indicate willingness to engage in a written interim agreement with municipality to ascertain if the municipality complies with minimum requirements with regard

to capacity to perform the functions set to be assigned as contemplated in sections 88(1), 102(1) or 225(1) of the Children's Act, respectively.

- Make certain prescribed requirements known to the municipality
- Inform the municipality in writing, of the requirements, any gaps, the timeframes and the procedures to be followed to comply with the requirements for the assignment of functions

### 7.3. Initial Interim agreement between the provincial Department of Social Development and a municipality

(a) The purpose of the interim agreement is to formalise the process of assessment of the municipality by the provincial Department of Social Development to ascertain whether the municipality meets the minimum requirements with regard to capacity and financing to perform the functions set to be assigned as contemplated in sections 88(1), 102(1) and 225(1) of the Children's Act, respectively. It is not a commitment by either party that any function will be assigned.

(b) The interim agreement shall contain the following minimum information:

- Mutual agreement to the assessment of the municipality for the purpose of assignment of functions.
- The specific procedures and timelines attached to the said assessment.
- The specific roles and responsibilities of each party (provincial Department of Social Development and municipality).
- Documents that need to be made available and persons who will be made available by the municipality for the assessment.
- An indication that the assessment does not commit either party to assign functions or accept the assignment of functions.
- Any other relevant matter that may be mutually agreed upon.

(c) The interim agreement shall be duly signed by the HOD and the municipal manager and should contain timeframes and requirements for reporting.

#### **7.4. Basic Requirements for the assignment of functions to municipalities**

(a) Sections 88(1), 102(1) and 225(1) of the Children's Act, respectively, indicate that the assignment of functions related to partial care, early childhood development and drop-in centres must correspond with minimum requirements with regard to capacity and financial ability of the municipality to perform the functions set to be assigned. The following paragraphs give an indication of the basic requirements that need to be in place for the assignment of functions to a municipality. These are linked to the assessment process that is dealt with in the section below.

(b) The minimum requirements with regard to the capacity of the municipality to perform the functions set to be assigned include:

(i) Requirements as set out in Regulation 22(2) of Children's Act 38 of 2005 regarding:

- a) Skills, knowledge and qualifications of staff that will enable the municipality to implement the assigned function;
- b) Adequate staff to implement the assigned functions;
- c) Ability of the municipality, including the allocated staff, to develop capacity and monitor the implementation of the minimum norms and standards as it pertains to the assigned function.
- d) The overall capacity of the municipality to implement the assigned function.
- e) The financial ability of the municipality in terms of allocated funding to sustain these functions.

(ii) The willingness of the municipality at political and administrative level to manage and implement the assigned function.

(iii) The financial management capacity of the municipality, inclusive of the available funding for the functions to be assigned.

(iv) The Integrated Development Plan (IDP) of the municipality and how it facilitates the intended assignment of functions and the Annual Performance Plan (APP) of the municipal manager.

(v) Existing policies and by-laws pertaining to services to children and compliance with national legislation with particular reference to the safety, development and inclusion of children with disabilities and chronic illnesses.

(vi) Data collection and information management technology system within the municipality that are needed to record, manage and implement the assigned functions.

(vii) Existing monitoring systems that will assist with compliance and the implementation of the assigned functions and reporting thereof.

(viii) Physical resources required for the implementation of the assigned functions such as infrastructure, vehicles, computers, printers, internet connection, furniture, etc.

(ix) Existing systems and procedures for the environmental health assessment of child care facilities.

(x) General working conditions of staff and observation of occupational health and safety measures.

(xi) Existence of a municipal profile that identifies the needs of children and families, focusing on the status of services and the demand for services that would be rendered through the functions to be assigned.

(xii) The identification of the special needs of children with disabilities and what those disabilities may be in the numbers that the municipality has to provide services for.

#### **7.5. Assessment of a municipality by the provincial Department of Social Development**

(a) The assessment of municipalities by the provincial Department of Social Development shall be uniform and based on the basic requirements mentioned above. This will ensure consistency and adherence with the provisions of the Children's Act, its regulations, minimum norms and standards and the requirements set out in this Document.

(b) The assessment shall contain two parts, namely:

(i) A self-assessment to be completed by the municipality based on the basic requirements which will be submitted to the provincial Department of Social Development prior to an assessment by the said Department.

(ii) An assessment by the provincial Department of Social Development based on the requirements in the Children's Act and the self-assessment by the municipality. The assessment shall be based on verifiable facts, sources and source documents.

(c) These shall be included in the assessment:

(i) The willingness and commitment to undertake the implementation of the assigned functions, giving consideration to the:

- Integrated Development Plan (IDP) of the municipality (provisions and level of current execution);
- Resolutions regarding the assignment of functions made by the Municipal Council as well as other related resolutions that pertain to the provision of services to children and families;
- Experience in service provision to children (existing services);
- Budget allocations of the municipality.

(ii) Skills and knowledge of staff, which will include:

- Qualification ;
- Experience and staff capacity;
- Content or technical knowledge of the particular function to be assigned;
- Financial management skills;
- Planning skills;
- Overall ability to implement programmes.

(iii) Staffing and staff structure to manage and implement the assigned functions, focusing on:

- Existing staff structures and location of the management of the assigned functions;
- Compliance of relevant staff members with professional registration;
- Support and supervision available to staff on the management and implementation of the assigned function.

- Roles and responsibilities (workplans ) of identified staff.

(iv) Integrated Development Plan (IDP) of the municipality, with emphasis on:

- Linkages between the intended functions to be assigned and the objectives of the IDP;
- The budget allocated to the IDP's implementation;
- Provisions in the IDP to provide services to children and families;
- Implementation plan related to the IDP, and level of execution;
- Accountability structures and procedures related to the implementation of the IDP;
- Role of ward committees in the monitoring of the implementation of the IDP.

(v) Environmental health and safety assessments and procedures

- Environmental health policy and procedures;
- Monitoring of the compliance with environmental health standards;
- Procedure of issuing certificates and number certificates issued, withdrawn and reassessed in relation to ECD, partial care and drop-in centres;
- Timeframe of environmental health assessments and issuing of certificates.

(vi) By-laws and municipal policy

- Existing policy and by-laws that pertain to or impact on children and families and/or the functions to be assigned;
- Compliance with national legislation and policy;
- Involvement of service recipients/beneficiaries in the development and implementation of by-laws and policies;
- Monitoring of policy and by-law implementation once identified
- Coordination and collaboration with relevant stakeholders.

(vii) Monitoring, data collections and information technology needed for the implementation of the assigned functions:

- Data collection and capturing capacity;
- Available data and how it is used;

- How data feed into the IDP and action plans;
- Monitoring mechanisms and systems in place;
- Reporting mechanisms in place and accountability lines;
- Role of the municipal council in the monitoring of service delivery.

#### 7.6. Assessment report, review and recommendation

(a) The provincial Department of Social Development shall compile a comprehensive report on the assessment, based on the principles set out in the section above, which will provide a factual and impartial analysis of whether the municipality meets the minimum requirements for the assignment of functions as contemplated in sections 88(1), 102(1) and 225(1) of the Children's Act.

(b) The said report shall indicate the:

- Process and procedures followed in the assessment;
- Names, position and qualifications of staff from the provincial Department of Social Development who conducted the processes and were involved in the assessment of the municipality;
- Details of the parties (persons/groups), the documents and the sources consulted;
- Main findings against the stipulated requirements and assessment criteria;
- Recommendation in relation to the assignment of functions, i.e. recommended; recommended with conditions or not recommended;
- Contact person in the provincial Department of Social Development;
- Copy of the self-assessment by the municipality.

(c) The report shall be submitted to the Municipal Manager to provide the municipality an opportunity to comment, in writing, and correct facts (in writing with evidence) within 30 days. The revised report will then be made available to the Municipal Manager within 30 days.

(d) The person who conducted the assessment shall give due consideration to the comments and inputs of the Municipality in compiling the final report to be submitted to HOD and Municipal Manager.

#### 7.7. Decision on the assignment of functions by the HOD

The HOD giving due consideration to the report compiled based on the assessment of the municipality and the recommendations made therein and any further input or evidence, may make a decision in relation to the assignment of functions regarding partial care, early childhood development or drop-in centres as contemplated in the relevant section decide to:

- (i) Assign a function to the municipality (unconditional); or
- (ii) Assign a function to the municipality with certain conditions and provide a motivation; or
- (iii) Not assign a function to a municipality, with reasons.

(b) The HOD shall communicate his/or her decision to the Municipal Manager in writing within 30 days with a clear indication on the process to be followed.

(c) The Municipal Manager shall acknowledge receipt in writing of the aforementioned letter and

- (i) Indicate that the municipality is willing to proceed with the assignment of functions if such functions were to be assigned; or
- (ii) Indicate that the municipality is willing to proceed with the assignment of functions with certain conditions if such functions were to be assigned with conditions; or
- (iii) Indicate that the municipality notes the decision of the HOD not to assign functions and that it is satisfied with the reason given;

(iv) Indicate that the municipality notes the decision of the HOD not to assign functions and that it is not satisfied with the reason given.

(d) In the case where the HOD decides not to assign any functions to the municipality and the municipality is not satisfied with the reasons given, the municipality may request the decision to be reviewed.

(i) The Municipal Manager has to lodge such a request with the office of the MEC in the province where the municipality is situated within 30 days and request the MEC to review the decision.

(ii) The MEC for Social Development in consultation with the MEC responsible for Local Government shall review the decision by the HOD, in order to ascertain whether all facts were considered in the application and whether a just and fair decision was taken. Based on the aforementioned the MEC for Social Development shall reach a final decision and communicate that to the municipal manager and the HOD.

#### **7.8. Agreement between the provincial Department of Social Development and a municipality on the assignment of functions**

Regulation 22(4) prescribes that the following items shall be included in the agreement on the assignment of functions:

- (a) A strategic plan containing a business plan for a period of three years, an operational plan for a period of a year on year basis and a budget for the period of three years;
- (b) A service level agreement;
- (c) An organogram for the component/s responsible for the administration of the assigned functions; and
- (d) A provision to the effect that the items contemplated in paragraphs (a), (b) and (c) must be reviewed, updated and reported on annually.

In addition to the requirements as set out in regulation 22(4), the formal agreement shall include the following:

- (i) Details on the specific function(s) that is/are assigned;
- (ii) Funding arrangements, if any, in respect of the functions that are assigned, and including the arrangements for the transfer of funds and conditions attached to it;
- (iii) Staffing and capacity arrangements;
- (iv) Training, capacity development and mentoring;
- (v) Monitoring and reporting;
- (vi) Review of agreement;
- (vii) Timeframes related to the assignment of functions;
- (viii) Transitional arrangements for the transfer of functions from the provincial department of social department to the municipality;
- (ix) Conditions, if any;
- (x) Any other matters that need to be included in the agreement.

#### **7.9. Transitional arrangements**

(a) When functions are assigned, it is essential that certain transitional arrangements be made to ensure the smooth transfer of the assigned functions and to prevent the disruption of services, agreements with service providers and related matters.

(b) These transitional arrangements should be based on an agreed plan and be included in the agreement between the provincial Department of Social Development and the municipality.

(c) These transitional arrangements shall include, but not be limited to, the following:

- Agreed transitional function period/timeframe;
- Joint communication to all stakeholders based on a communication plan indicating the change in arrangements, communication, contact people, etc.;

- Orientation and capacity development of municipal staff in relation to the assigned function;
- Budget agreements and arrangements;
- Transfer of files and relevant documents;
- Handover report from provincial Department of Social Development to the municipality;
- Handover of data and information database from the provincial Department of Social Development to the municipality.

#### **7.10. Implementation of the assigned functions by the municipality**

(a) The implementation of the assigned functions shall be in accordance with the signed agreement, based on the strategic plan, an operational plan and a budget for a period of three years.

(b) The municipality is responsible for adherence to the requirements of the Children's Act, its Regulations and Norms and Standards as they pertain to the assigned function.

(c) The municipality shall employ its internal mechanisms for the monitoring and reporting of service delivery.

(d) The provincial Department of Social Development shall continue with mentoring and capacity development of the municipality as agreed.

(e) The municipality shall include a human resource capacity development strategy pertaining to the execution of the assigned function in its overall human resource development strategy and budget.

(f) The municipality shall communicate with the provincial Department of Social Development as agreed or as the need arises on issues pertaining to implementation.

(g) The municipality may establish a local mechanism to coordinate services in relation to the assigned function or functions.

#### **7.11. Monitoring and review by the provincial Department of Social Development**

(a) The provincial Department of Social Development is responsible for monitoring the agreement on the assigned functions and the implementation of the agreement. In order to give effect to the aforementioned, the provincial Department of Social Development and the municipality will need to agree on the:

- (i) Indicators to be monitored;
- (ii) Reports to be submitted by the municipality and the timeframes related to such reporting undertakings (timeframes can be shorter in the beginning and extend over time);
- (iii) Monitoring and support visits to the municipality at least every six months;
- (iv) Quality assurance to be conducted at least annually during the first three years and every three years thereafter.

(b) The HOD may, at any time, review the agreement on the assignment of functions to a municipality, based on the findings of any monitoring report or visit by the provincial Department of Social Development.

#### **7.12. Amendment of agreement to the assigned functions**

(a) The HOD may, as contemplated in sections 88 (8) (c) (i), 102(8) (c) (i) and 225(8) (c) (i), amend the written agreement with the municipality on the assignment of functions. Such an amendment would be based on the monitoring by the provincial Department of Social Development of the implementation of the functions assigned, as contemplated in sections 88 (8)(a), 102(8)(a) and 225(8)(a) of the Children's Act. The amendment may also include reduction, addition, restriction or conditions on the assigned functions. The HOD must communicate in writing his or her intention and

decision to amend the assignment and allow the municipal Manager 30 days to respond.

(b) The Municipal Manager may also request the HOD, with reasons, to amend the written agreement with the municipality on the assignment of functions.

#### **7.13. Withdrawal of the agreement on the assignment of functions**

- a) The HOD may, as contemplated in sections 88 (8) (c) (ii), 102(8) (c) (ii) and 225(8) (c) (ii), withdraw the written agreement with the municipality on the assignment of functions if it appears that the municipality no longer has the capacity to perform some or all of the functions that were assigned. Such a withdrawal will be based on the monitoring performed by the provincial Department of Social Development of the implementation of the functions assigned, as contemplated in sections 88 (8)(a), 102(8)(a) and 225(8)(a) of the Children's Act.
- b) The Municipal Manager may request the HOD, with reasons, to withdraw some or all of the functions that were assigned.
- c) In the case of a withdrawal of the functions assigned, transitional arrangements shall be made to ensure the smooth transfer of functions back to the provincial Department of Social Development.
- d) The withdrawal of assigned functions should not have adverse effects on service beneficiaries.

#### **7.14. Procedures for the delegations by the municipal manager**

(a) Any power or duty that the municipal manager delegates in terms of 88(3), 102(3) and 225(3) of the Children's Act, shall be subject to the provisions of the Children's Act and;

- (i) shall be in writing;
- (ii) Shall be specific;
- (iii) Shall indicate the specific post level and provide details of the person so delegated.

### **8. GUIDELINES FOR MUNICIPALITIES TO SUPPORT AND FACILITATE THE IMPLEMENTATION OF THE CHILDREN'S ACT**

#### **8.1. Play and recreation**

Section 6 of the Children's Act dealing with general principles, has as one of its principles 'the recognition of the child's need for development and to engage in play and other recreational activities appropriate to the child's age.'

As municipalities have the executive authority in relation to the establishment and maintenance of amusement facilities, local amenities, sport facilities, municipal parks and recreational facilities, they therefore have a responsibility to give effect to section 6 (2) (e) of the Act.

#### **8.2. Services for children with disabilities**

All stakeholders and organs of state involved in the implementation of the Act must recognize and respect the rights of children with disabilities and create an enabling environment to respond to the special needs that these children have.

Municipalities have authority in relation to child care facilities, local amenities, municipal health services, as well as public transport.

Therefore, they have to ensure an enabling environment for children with disabilities by making public amenities, facilities and public transport accessible to children with disabilities.



Municipal health and welfare services should provide the necessary support services to children with disabilities as provided for in section 11(d) of the Children's Act.

### 8.3. Provision of health services

In their endeavour to provide health services, municipalities should ensure that children and their families have access to information on health promotion, the prevention and treatment of ill-health and disease, sexuality and reproduction needs. (Section 13 of the Children's Act).

The Children's Act acknowledges primary obligation of parents to care for and guide their children. However, there are some children without proper parental guidance, those who experiment and get involved in sexual activities, as well as those who are victims of abuse. Taking into account these categories of children, providing reproductive health services to such children is important as a prevention measure to avoid unwanted pregnancies and contracting of sexually transmitted infections.

Municipal health facilities that provide reproductive health services should provide such services to children upon request of the children in terms of section 134 of the Act.

Notwithstanding the provisions of section 134, the Act has built in a protective measure in section 110. Section 110 (1) stipulates that a health practitioner, who on reasonable grounds concludes that a child is being abused, must report that conclusion to a designated social worker or a police official. A **'designated social worker'** for this purpose, is a social worker in the service of-

- (a) the department of social development;
- (b) a designated child protection organisation; or
- (c) a municipality;

A child who approaches a health practitioner for reproductive health services may be found to be a child in need of care and protection and might require child protection services.

### 8.4. Provision of childcare facilities

Partial care facilities that provide ECD programmes, after school centers/services and respite care centre /services, as well as drop-in centres may be regarded as child care facilities over which municipalities have executive authority in terms of the Constitution.

This means that municipalities are empowered by the Constitution to provide these facilities and there is no need for the Department of Social Development to assign the function to municipalities to provide these services.

### 8.5. Child Protection Services

Section 110 of the Act provides a list of persons who are obliged to report cases of abuse and/ or deliberate neglect of children. Professionals and practitioners employed by municipalities including social workers, health practitioners, social service practitioners, staff members and volunteers at childcare facilities are obliged to report cases to the local Department of Social Development, a designated child protection organization or a police official using Form 22.

Municipal employees who work directly with children, including social workers, volunteers, community development workers, librarians, lifeguards at swimming pools, etc., shall be subject to screening against the National Child Protection Register as contemplated in the Children's Act and the National Register for Sex Offenders.

Before appointing a person to work with or have access to children, a municipality must forward a request to the Director-General of Social Development using Form 29

to establish whether that person's name appears in Part B of the National Child Protection Register. A manager of a childcare facility that operates in a municipality must also forward Form 29 requests for their current employees and Form 30 requests for themselves to establish whether their names appear in the National Child Protection Register.

### 8.6. Prevention and early intervention services

The direct role of municipalities in providing prevention and early intervention services/programmes include:

- Assisting families to obtain the basic necessities of life.
- Empowering families to obtain such necessities for themselves.
- Providing families with information to enable them to access appropriate and relevant services.
- The basic necessities of life may include relevant documents such as birth certificates or identity documents; food, shelter, sanitation, water, ablution services or health care services.
- Programmes in line with by-laws relevant to children

### 8.7. Services to vulnerable children

Municipalities are close to communities, hence they play an important role in identifying and referring vulnerable children including children who are abused, neglected, exploited or trafficked; children without proper care and supervision; children in child headed households; children living, begging and working on the streets and children involved in child labour. These children may be reported to the local social development office, child protection organization or police.

Those municipalities that offer welfare services have an obligation to offer relevant assistance to such children; however, those children who need statutory intervention

should be referred to a designated social worker at a Designated Child Protection Organization or Provincial DSD.

### 8.8. Places of entertainment for children

Municipalities that have amusement, sports, and recreation facilities that accommodate children and are used by children should comply with section 140 of the Children's Act to ensure the safety of children and that children do not have access to alcohol, drugs, illegal substances or tobacco products.

The municipality has an obligation to inspect such facilities in terms of section 140(5).

Should a child be identified as a child at risk at a place of entertainment he/she should be referred to a designated social worker.

### 8.9. Norms and standards

The norms and standards for partial care facilities and drop-in centres require these facilities to:

- Provide a safe environment for children including the structural safety of the building.
- Adequate space and ventilation.
- Safe drinking water.
- Hygienic and adequate toilet facilities.
- Access to refuse disposal services.

It is the primary duty of municipalities to provide water, sanitation, sewage disposal, refuse removal and building regulations.

Municipalities should therefore assist facilities to comply with the norms and standards in order to be registered.

In relation to partial care, the transport operators are required to possess the necessary permits and they should comply with the transport safety regulations.

Municipal police officials have an obligation to ensure that transport operators comply with the relevant traffic and safety rules.

**8.10. Issuing of relevant certificates**

According to Regulation 14(f) of the Children’s Act, the municipality is required to issue a health certificate to confirm compliance of a partial care facility with the structural health requirements. In addition, new partial care buildings and alterations to buildings must comply with the National Building Regulations and Building Standards Act 103 of 1997, which is administered by municipalities.

In relation to child and youth care centres, the municipality must issue a certificate to confirm that a facility complies with the national and local building regulations, as well as the structural safety, health and other requirements of the municipality. The municipality has a responsibility to inspect the relevant facility before issuing a health certificate. They also have an obligation to assist and guide facilities to comply with the municipality by-laws and regulations.

**9. MUNICIPAL BY-LAWS IN RELATIONS TO THE ACT**

Municipal by-laws pertaining to children shall not be in conflict with the Children’s Act or provide for lesser quality standards for services to children than any national legislation.

Municipalities may seek advice from the Department of Social Development in the development and review of their by-laws, for example, by-laws relating to removal of children living, working or begging on the streets or by-laws for issuing health certificates for registration of child care facilities.

**10. ROLES AND RESPONSIBILITIES**

Element	Principles	Recommended practice
1. Finance and capacity	A provincial Department of Social Development initiating the assignment of functions or powers to a municipality must ensure sufficient funding and capacity building initiatives as may be needed for the performance of the assigned functions or powers by the municipalities concerned.	The MEC and the HOD must take appropriate steps to ensure sufficient funding, and capacity building initiatives if— (a) the assignment imposes a duty on the municipalities concerned; (b) that duty falls outside the functional areas listed in Part B of Schedule 4 or Part B of Schedule 5 of the Constitution or is not incidental to any of those functional areas; and (c) the performance of that duty has financial implications for the municipality concerned.  Where applicable, the agreement between the Department and the municipality must stipulate the provision of adequate resources, payment schedules, and so on.
	A municipality initiating the assignment of	The Municipal Manager must ensure an assessment of the

Element	Principles	Recommended practice
	functions or powers must ensure sufficient funding and capacity as may be needed for the performance of the assigned function or power concerned.	<p>financial and human resource capacity of the municipality to perform the envisaged functions.</p> <p>The results of the assessment must be contained in an assessment report.</p> <p>Where applicable, the Agreement between the Department and the municipality must stipulate the resources the municipality will provide and any additional resources required from the Department to close the funding or human resource gap.</p>
2. Assessment of the municipality	The municipality must conduct an internal assessment and compile an assessment report before an assessment by the Department.	<p>Conduct a needs assessment to assess the capacity of the municipality to perform the function in respect of:</p> <ul style="list-style-type: none"> <li>• Adequate staff, including relevant social service professionals who are</li> </ul>

Element	Principles	Recommended practice
	The Department must in consultation with the municipality, conduct a comprehensive assessment of a municipality before assigning any functions in terms of the Children's Act.	<p>suitably qualified and skilled.</p> <ul style="list-style-type: none"> <li>• The ability to render the required services and to ensure compliance with legislation and the relevant norms and standards.</li> <li>• The capacity to manage the functions to be assigned.</li> <li>• Financial resources required to perform the functions that will be assigned.</li> </ul>
3. Service Delivery Agreement	The Department and the relevant municipality must sign a Service Delivery Agreement before any assigned functions may be performed.	<p>Develop and sign an agreement with regard to the assignment of the function. The agreement must be accompanied by the following:</p> <ul style="list-style-type: none"> <li>• A clause stating the duration of the agreement.</li> <li>• Clearly defined roles and responsibilities.</li> <li>• A strategic plan containing an operational plan for a period of one</li> </ul>

Element	Principles	Recommended practice
		<p>year and a budget for a period of three years.</p> <ul style="list-style-type: none"> <li>An organogram for the staff establishment responsible for the administration of the assigned functions.</li> </ul> <p>The strategic plan, the service level agreement and organogram must be reviewed and updated every three years.</p> <p>The agreement must be signed and dated by the relevant parties in the presence of two witnesses for each party.</p> <p>The agreement must be in a form similar to Form 55 in terms of the Children’s Act or Annexure A .</p>
4. Responsible leadership	The HOD and the Municipal Manager should provide effective leadership based on an ethical and corruption free foundation.	<p>Ethical leaders should:</p> <ul style="list-style-type: none"> <li>Direct the strategy and operations to build sustainable services;</li> <li>Consider the short- and long-term impact of the</li> </ul>

Element	Principles	Recommended practice
		<p>strategy on the community and society</p> <ul style="list-style-type: none"> <li>Take account of the organisation’s impact on internal and external stakeholders.</li> <li>The municipal council of a municipality, has the duty to exercise the municipality’s executive and legislative authority and use the resources of the municipality in the best interests of the local community, within the municipality’s financial and administrative capacity,</li> </ul>
5. Performance assessment after the assignment of functions.	The performance of the assigned functions should be evaluated within the prescribed periods as contained in the Service Delivery Agreement.	<ul style="list-style-type: none"> <li>The Provincial Department and the municipality should set performance criteria that will serve as a benchmark for the performance appraisal.</li> <li>Performance monitoring should be performed by both parties and the results should identify</li> </ul>

Element	Principles	Recommended practice
		developmental needs, which will inform the Organisational Development Plan. <ul style="list-style-type: none"> <li>• An overview of the appraisal process, results and action plans should be disclosed in an integrated report.</li> <li>• The continuation of the performance of the assigned functions should only occur after an appraisal that reveals satisfactory results.</li> </ul>
6. Monitoring and evaluation of assigned functions.		
6.1. Audit		
6.1.1. The need for and role of internal audit.	The municipality should ensure that there is an effective risk-based internal audit.	The municipality should establish an internal audit function. The internal audit should perform the following functions: <ul style="list-style-type: none"> <li>• Evaluate the municipality's governance processes;</li> <li>• Perform an objective</li> </ul>

Element	Principles	Recommended practice
		assessment of the effectiveness of risk management and the internal control framework; <ul style="list-style-type: none"> <li>• Systematically analyse and evaluate business processes, the governance of the functions assigned and associated controls; and</li> <li>• Provide guidelines for dealing with cases of fraud, corruption, theft, unethical behaviour and irregularities.</li> </ul>
	The audit committee should be an integral component of the risk management process.	The Terms of Reference of the audit committee should set out its responsibilities regarding risk management. The audit committee should specifically have oversight of:

Element	Principles	Recommended practice
		<ul style="list-style-type: none"> <li>financial reporting risks;</li> <li>internal financial controls;</li> <li>fraud risks as it relates to financial reporting.</li> </ul>
6.1.2. Reporting on the results of the internal audit.	The audit committee should report on how it has discharged its duties over the intervals as agreed in the terms of reference	The audit committee should report internally to the municipal council on how its duties were carried out, findings made, and any recommendations.
6.2. The governance of risk		
6.2.1. Management's responsibility for risk management.	The municipal manager should be responsible for the governance of risk	<p>A plan for a system and process of risk management should be developed.</p> <p>The municipal manager should ensure that the implementation of the risk management plan is monitored continually</p>

Element	Principles	Recommended practice
6.2.2. Risk assessment	The municipal manager should ensure that risk assessments are performed on a continual basis	<p>The municipality must ensure effective and ongoing risk assessments.</p> <p>A systematic, documented, formal risk assessment should be conducted at least once a year by the municipality.</p> <p>Risks should be prioritised and ranked to focus responses from and interventions by.....</p> <p>The risk assessment process should identify the risks affecting various assigned functions, the sustainability of services and the legitimate interests and expectations of stakeholders.</p>
6.2.3. Risk monitoring	The municipal manager should ensure continual risk	The municipal manager should

Element	Principles	Recommended practice
	monitoring and appropriate risk responses.	<p>ensure that effective and continual monitoring of risk management takes place.</p> <p>The responsibility for monitoring should be defined in the risk management plan.</p> <p>Management should also demonstrate how risk response provides for the identification and exploitation of opportunities to improve the performance of the municipality in respect of the assigned functions.</p>
6.2.4. Risk assurance	The Provincial Department of Social Development should receive assurance regarding the effectiveness of the risk management process	The municipality should provide assurance to the Provincial Department of Social Development that the risk management plan

Element	Principles	Recommended practice
		<p>is integrated in its routine activities and is supported by evidence.</p> <p>Internal audit should provide a written assessment of the effectiveness of the system of internal controls and risk management to the municipal council.</p>
6.2.5. Risk disclosure	The municipality should ensure that there are processes in place enabling complete, timely, relevant, accurate and accessible risk disclosure to the Department and stakeholders supported by evidence.	<p>Undue, unexpected or unusual risks should be disclosed in the monitoring and evaluation report.</p> <p>Emergency measures should also be detailed.</p> <p>The municipality should disclose its view on the effectiveness of the risk management process in the M&amp;E report.</p>



Element	Principles	Recommended practice
7. Compliance with laws, rules, codes and standards	The municipal manager should ensure that the municipality complies with applicable laws and must impose consider adherence to rules, codes and standards and layout the penalties for non-compliance.	<p>Municipalities must comply with all applicable laws.</p> <p>Exceptions permitted in law, shortcomings and proposed changes expected should be handled ethically and in an informed manner</p> <p>Compliance should be a legal and ethical imperative.</p> <p>Compliance with applicable laws should be understood not only in terms of the obligations that they create, but also for the rights and protections that they afford.</p> <p>The municipality should understand the context of the Children's Act and</p>

Element	Principles	Recommended practice
		how other applicable legislation interact with it.

**11. COMMUNICATION PLAN**

Provincial Heads of Social Development and Provincial Heads of Departments responsible for Local Government are requested to bring the content, responsibilities and compliance issues of this Document to the attention of relevant social workers, social auxiliary workers, child and youth care workers, community development workers and practitioners, municipal managers and mayors.

**ANNEXURE A: AGREEMENT FORM**

**AGREEMENT BETWEEN PROVINCIAL HEAD OF SOCIAL DEVELOPMENT AND MUNICIPALITY IN TERMS OF (Regulation 22, 29 and 96)**

**[SECTION 88 (2), 102 (2) and 225(2) OF THE CHILDREN’S ACT 38 OF 2005]**

I \_\_\_\_\_  
 (full names) in my capacity as the Head of the Provincial Department of Social Development in the \_\_\_\_\_Province (name of the province) and duly authorized by .....thereto

AND

\_\_\_\_\_ (full names) in my capacity as the Municipal Manager of the \_\_\_\_\_ (name of municipality) and duly authorized thereto

hereby agree that the functions contemplated in the following sections of the Children’s Act, Act 38 of 2005 be assigned to the Municipal Manager of the \_\_\_\_\_ (name of municipality) with effect from \_\_\_\_\_ to \_\_\_\_\_ (date)

(Tick whichever is applicable)

Partial Care	(tick with an X)	ECD	(tick with an X)	Drop in centres	(tick with an X)
80		95		217	
81		96		218	
82		97		219	
83		98		220	
84		99		221	
85		100		222	
87				224	

SIGNED at \_\_\_\_\_ on this \_\_\_\_\_ day of \_\_\_\_\_

As Witnesses:

1. ....
2. ....

\_\_\_\_\_  
 Provincial HOD

As Witnesses:

1. ....
2. ....

\_\_\_\_\_  
 Municipal Manager

SIGNED at .....on this .....day of  
 .....(20.....)

**ANNEXURE B: FORM 22**

**REPORTING OF ABUSE OR DELIBERATE NEGLECT OF CHILD**

(Regulation 33)

[SECTION 110 OF THE CHILDREN'S ACT 38 OF 2005]

**REPORTING OF ABUSE TO PROVINCIAL DEPARTMENT OF SOCIAL DEVELOPMENT, DESIGNATED  
 CHILD PROTECTION ORGANISATION OR POLICE OFFICIAL**

**NOTE: A SEPARATE FORM MUST BE COMPLETED FOR EACH CHILD**

TO: The Head of the Department

.....  
 .....  
 .....  
 .....

Pursuant to section 110 of the Children's Act, 2005, and for purposes of section 114(1)(a) of the Act, you are hereby advised that a child has been abused in a manner causing physical injury/ sexually abused/ deliberately neglected or is in need of care and protection.

<b>Source of report (do not identify person)</b>			
<input type="checkbox"/> Victim	<input type="checkbox"/> Relative	<input type="checkbox"/> Parent	
<input type="checkbox"/> Neighbour	<input type="checkbox"/> friend	<input type="checkbox"/> Professional (specify) .....	
<input type="checkbox"/> Other (specify) .....			
<b>Date Reported to child protection organisation:</b>	<b>DD</b>	<b>MM</b>	<b>CCYY</b>

1. CHILD: (COMPLETE PER CHILD)						
Surname			Full name(s)			
Gender:	M	F	Date of Birth:	DD	MM	CCYY
School Name:			Grade:	Age / Estimated Age:		
* ID no:			* Passport no:			
Contact no:						

2. CATEGORY OF CHILD IN NEED OF CARE AND PROTECTION	
<input type="checkbox"/> Child abuse	<input type="checkbox"/> Child labour
<input type="checkbox"/> Child trafficking	<input type="checkbox"/> Street child
<input type="checkbox"/> Commercial sexual exploitation	<input type="checkbox"/> Exploited children
	<input type="checkbox"/> Child abduction

3. OTHER INTERVENTION – CONTACT PERSON TRUSTED BY CHILD	
Surname:	Name:
Physical address:	Telephone number:
Other children interviewed: <input type="checkbox"/> Yes <input type="checkbox"/> No      Number :	

4. CAREGIVER INFORMATION ( If not same as trusted person or parent(s) of child)	
Surname:	Name:
Physical Address:	Postal address
Relationship to child:	
Telephone number:	Mobile:

5. ALLEGED ABUSER						
5.1) Surname			Full Name(s)			
Date of Birth:	DD	MM	CCYY	Gender:	M	F
ID No:			Age:			
* Passport No:			* Drivers license number:			
Also known as:			Relationship to child:			
			<input type="checkbox"/> Father <input type="checkbox"/> Mother <input type="checkbox"/> Grandfather <input type="checkbox"/> Grandmother <input type="checkbox"/> Step father <input type="checkbox"/> Step mother			



--	--

7. ABUSE									
Date of Incident:			If date unknown (mark with X here):	Episodic/ongoing from (date)			Reported to CPR:		
DD	MM	CCYY		DD	MM	CCYY	DD	MM	CCYY
<b>Place of incident:</b> <input type="checkbox"/> Child's home <input type="checkbox"/> Field <input type="checkbox"/> Tavern <input type="checkbox"/> School <input type="checkbox"/> Friend's place <input type="checkbox"/> After school centre <input type="checkbox"/> ECD Centre <input type="checkbox"/> Neighbour <input type="checkbox"/> Private hostel <input type="checkbox"/> Child and youth care centre <input type="checkbox"/> Foster home <input type="checkbox"/> Temporary safe care <input type="checkbox"/> temporary respite care <input type="checkbox"/> Other (specify)									
7.1) TYPE OF ABUSE (Tick only the one that indicates the key motive of intent)									
Physical		Emotional		Sexual		Deliberate neglect			
7.2) INDICATORS (Check any that apply)									
<b><u>PHYSICAL:</u></b> <input type="checkbox"/> Abrasions <input type="checkbox"/> Bruises <input type="checkbox"/> Burns/Scalding <input type="checkbox"/> Fractures <input type="checkbox"/> Other physical illness <input type="checkbox"/> Cuts <input type="checkbox"/> Welts <input type="checkbox"/> Repeated injuries <input type="checkbox"/> Fatal injury (date of death) <input type="checkbox"/> Injury to internal organs <input type="checkbox"/> Head injuries <input type="checkbox"/> No visible injuries (elaborate) <input type="checkbox"/> Poisoning (specify) <input type="checkbox"/> Other Behavioral or physical (specify)									

<b><u>EMOTIONAL:</u></b> <input type="checkbox"/> Withdrawal <input type="checkbox"/> Depression <input type="checkbox"/> Self destructive aggressive behaviour <input type="checkbox"/> Corruption through exposure to illegal activities <input type="checkbox"/> Deprivation of affection <input type="checkbox"/> Exposure to anti-social activities <input type="checkbox"/> Exposure to family violence <input type="checkbox"/> Parent or care giver negative mental condition <input type="checkbox"/> Inappropriate and continued criticism <input type="checkbox"/> Humiliation <input type="checkbox"/> Isolation <input type="checkbox"/> Threats <input type="checkbox"/> Development Delays <input type="checkbox"/> Oppression <input type="checkbox"/> Rejection <input type="checkbox"/> Accusations <input type="checkbox"/> Anxiety <input type="checkbox"/> Lack of cognitive stimulation <input type="checkbox"/> Mental, emotional or developmental condition requiring treatment (specify)	
<b><u>SEXUAL:</u></b> <input type="checkbox"/> Contact abuse <input type="checkbox"/> Rape <input type="checkbox"/> Sodomy <input type="checkbox"/> Masturbation <input type="checkbox"/> Oral sex area <input type="checkbox"/> Molestation <input type="checkbox"/> Non contact abuse (flashing, peeping) <input type="checkbox"/> Irritation, pain, injury to genital <input type="checkbox"/> Other indicators of sexual molestation or exploitation (specify)	
<b><u>DELIBERATE NEGLECT:</u></b> <input type="checkbox"/> Malnutrition <input type="checkbox"/> Medical <input type="checkbox"/> Physical <input type="checkbox"/> Educational <input type="checkbox"/> Refusal to assume parental responsibility <input type="checkbox"/> Neglectful supervision <input type="checkbox"/> Abandonment	
7.3) Indicate overall degree of risk to child:	
<input type="checkbox"/> Mild <input type="checkbox"/> Moderate <input type="checkbox"/> Severe <input type="checkbox"/> Unknown	

**7.4) Where applicable, tick the secondary type of abuse or multiple abuse:**  Yes  No

Sexual	Physical	Emotional	Deliberate Neglect
Brief explanation of occurrence(s) (including a statement describing frequency and duration)			

**8. MEDICAL INTERVENTION (\*)**

<b>Examined by:</b>	<b>Treatment received:</b>	<b>Where (name of hospital, clinic, private doctor):</b>	<b>Hospitalised:</b>
<input type="checkbox"/> Doctor	<input type="checkbox"/> Yes		<input type="checkbox"/> For assessment
<input type="checkbox"/> Reg. Nurse	<input type="checkbox"/> No		<input type="checkbox"/> For treatment
			<input type="checkbox"/> As temporary safe care (place of safety)
<b>Contact person:</b>	<b>Contact person:</b>	<b>Contact person:</b>	<b>Contact person:</b>
<b>Telephone No:</b>	<b>Telephone No:</b>	<b>Telephone No:</b>	<b>Telephone No:</b>

**9. CHILDREN'S COURT INTERVENTION (\*)**

<b>Removal of child to temporary safe care (Section 152):</b>	<b>Date</b>		
<input type="checkbox"/> Yes <input type="checkbox"/> No	MM	DD	CCYY

**10. SAPS: (ACTION RELATED TO ALLEGED ABUSER(S)) - (\*)**

<b>Reported to SAPS:</b>	<b>Charges laid:</b>	<b>Date</b>

<input type="checkbox"/> Yes <input type="checkbox"/> No	<input type="checkbox"/> Yes <input type="checkbox"/> No	DD	MM	CCYY
<b>CASE NR</b>	<b>Police Station</b>	<b>Telephone Nr</b>		
<b>Name of Police Officer</b>		<b>Rank of Police Officer</b>		

**11. CHILD KNOWN TO DESIGNATED CHILD PROTECTION ORGANISATION (DCPO)/ SOCIAL DEVELOPMENT(DSD)?**

11.1) Child known to DCPO/DSD ? :  Yes  No

<b>Name of DCPO/DSD Office:</b>	<b>Contact number</b>	<b>Reference number</b>

**12. DETAILS OF PERSON WHO REPORTS ALLEGED ABUSE (Refers to a professional or mandatory obliged to report child abuse in terms of Section 110(1))**

**CAPACITY(OF INFORMANT)**

Caregiver	Correctional Official	Child and Youth Care Centre	Dentist	Doctor	Drop in Centre
Homeopath	Labour Inspector	Legal Practitioner	Midwife	Member of staff – partial care facility	Medical Practitioner
Minister of Religion	Nurse	Occupational Therapist	Psychologist	Police Official	Physiotherapist
Religious leader		Social service professional		Social worker	
Speech therapist		Shelter		Traditional leader	

<b>Teacher</b>	<b>Traditional health practitioner</b>	<b>Volunteer Worker – partial care facility</b>
<b>Other (specify)</b>		
<b>Surname of informant</b>	<b>Name of informant</b>	<b>Name of employer</b>
<b>Employer Address</b>	<b>Work Telephone Nr</b>	<b>Fax Number</b>
<b>Email Address</b>		

(\* ) = Complete if information is available or applicable

Date: \_\_\_\_\_

**Official Stamp**

I declare that the particulars set out in the above mentioned statement are true and correct to the best of my knowledge.

Signature of informant: \_\_\_\_\_



**ANNEXURE C: FORM 29**

**INQUIRY BY EMPLOYER TO ESTABLISH WHETHER PERSON'S NAME APPEARS IN PART B OF NATIONAL CHILD PROTECTION REGISTER**

(Regulation 44)

[SECTION 126 OF THE CHILDREN'S ACT 38 OF 2005]

TO: The Director-General  
 Department of Social Development  
 Private Bag X901  
 PRETORIA  
 0001

Dear Sir / Madam

In terms of section 126(1) / 126(2)\* of the children's Act, (No. 38 of 2005), I,.....  
 ..... (full names and surname) wish to inquire whether the name of a certain person is included in Part B of the National Child Protection Register. The particulars of the person are:

(\* - Delete which is not applicable)

1. EMPLOYEE'S DETAILS:	
Surname	Full name(s)

<b>Gender:</b>	<b>M</b>	<b>F</b>	<b>Date of Birth:</b>	<b>DD</b>	<b>MM</b>	<b>CCYY</b>
<b>* He / she is known as:</b>			<b>Driver's licence no:</b>			
<b>Alias (also known as):</b>						
<b>* ID no:</b>				<b>* Passport no:</b>		
<b>Physical Address:</b>				<b>Postal Address:</b>		
<b>* Telephone no:</b>				<b>Mobile no:</b>		
<b>The above-mentioned person will be / is currently* employed in the following position:</b>						

<b>2. DETAILS OF EMPLOYER - (My / our details are the following :)</b>
--



**ANNEXURE D: FORM 30**

**INQUIRY BY PERSON TO ESTABLISH IF HIS / HER NAME IS INCLUDED IN PART B  
OF NATIONAL CHILD PROTECTION REGISTER  
(REGULATION 50(1)(b))  
[SECTION 126(3) OF THE CHILDREN'S ACT, (No 38 OF 2005)]**

TO: The Director-General  
Department of Social Development  
Private Bag X901  
Pretoria  
0001

Dear Sir / Madam

In terms of section 126(3) of the Children's Act, (No. 38 of 2005), I \_\_\_\_\_

\_\_\_\_\_ (full names and surname) wish

to enquire whether my name is included in Part B of the National Child Protection Register. A certified copy

of one of the following documents is attached as verification of my identity.

<b>1. IDENTIFYING DOCUMENTS:</b>		
<b>One of the following identification documents must be attached:</b>		
<input type="checkbox"/> birth certificate (only if not in possession of identity document or passport)		
<input type="checkbox"/> identity document	<input type="checkbox"/> passport	<input type="checkbox"/> other (e.g. asylum)

**In the event that my name has been included in Part B of the Register, kindly furnish reason why this was done. My personal details are:**

<b>2. CONTACT DETAILS:</b>	
<b>Postal address:</b>	<b>Physical address:</b>
<b>* Email:</b>	
<b>Telephone No:</b>	<b>* Cellular No:</b>

(\* - if applicable)

**Please note that section 126 of the Act requires you to respond to this inquiry within 21 working days.**

**Yours sincerely**

\_\_\_\_\_  
**(Signature)**

# **ANNEXURE B**

REPUBLIC OF SOUTH AFRICA

---

# CHILDREN'S AMENDMENT BILL

---

*(As presented by Select Committee on Social Services (National Council of Provinces))*  
*(The English text is the official text of the Bill)*

---

(MINISTER OF SOCIAL DEVELOPMENT)

**[B 19B—2006]**

ISBN

No. of copies printed ..... 1 800

**GENERAL EXPLANATORY NOTE:**

Words underlined with a solid line indicate insertions in existing enactments.

---



---

## BILL

To amend the Children’s Act, 2005, so as to insert certain definitions; to provide for partial care of children; to provide for early childhood development; to make further provision regarding the protection of children; to provide for prevention and early intervention services; to provide for children in alternative care; to provide for foster care; to provide for child and youth care centres and drop-in centres; to create certain new offences relating to children; and to provide for matters connected therewith.

**B**E IT ENACTED by the Parliament of the Republic of South Africa, as follows:—

### Amendment of long title of Act 38 of 2005

1. The following long title is substituted for the long title to the Children’s Act, 2005 (hereinafter referred to as the principal Act):

5  
 “To give effect to certain rights of children as contained in the Constitution; to set out principles relating to the care and protection of children; to define parental responsibilities and rights; to make further provision regarding children’s courts; to provide for partial care of children; to provide for early childhood development; to provide for the issuing of contribution orders; to provide for prevention and early intervention services; to provide for children in alternative care; to provide for foster care; to provide for child and youth care centres and drop-in centres; to make new provision for the adoption of children; to provide for inter-country adoption; to give effect to the Hague Convention on Inter-country Adoption; to prohibit child abduction and to give effect to the Hague Convention on International Child Abduction; to provide for surrogate motherhood; to create certain new offences relating to children; and to provide for matters connected therewith.”

10  
 15

### Amendment of Table of Contents of Act 38 of 2005

2. The Table of Contents after the long title of the principal Act is hereby amended— 20  
 (a) by the insertion after “75. Regulations” of the following:

#### “CHAPTER 5

#### PARTIAL CARE

- |     |                                  |    |
|-----|----------------------------------|----|
| 76. | Partial care                     |    |
| 77. | Strategy concerning partial care | 25 |
| 78. | Provision of partial care        |    |

79. Norms and standards for partial care	
80. Partial care facility to be registered	
81. Application for registration and renewal of registration	
82. Consideration of application	
83. Conditional registration	5
84. Cancellation of registration	
85. Notice of enforcement	
86. Appeal against and review of certain decisions	
87. Record and inspection of and provision for partial care facility	
88. Assignment of functions to municipality	10
89. Death, abuse or serious injury of child in partial care facility	
90. Regulations	

## **CHAPTER 6**

### **EARLY CHILDHOOD DEVELOPMENT**

91. Early childhood development	15
92. Strategy concerning early childhood development	
93. Provision of early childhood development programmes	
94. Norms and standards for early childhood development	
95. Early childhood development programme to be registered	
96. Application for registration and renewal of registration	20
97. Consideration of application	
98. Conditional registration	
99. Cancellation of registration	
100. Notice of enforcement	
101. Assessment of early childhood development programmes	25
102. Assignment of functions to municipality	
103. <u>Regulations</u> ”;	

(b) by the insertion after “**PROTECTION OF CHILDREN**” of the following:

#### ***“Part 1***

##### ***Child protection system***

104. Strategy concerning child protection	30
105. Provision of child protection services	
106. Norms and standards concerning child protection	
107. Designation of child protection organisation	
108. Existing child welfare organisation	35
109. Withdrawal of designation	
110. <u>Reporting of abused or neglected child</u> ”;	

(c) by the insertion after “134. Access to contraceptives” of the following Part:

#### ***“Part 4***

##### ***Other protective measures***

135. Applications to terminate or suspend parental responsibilities and rights	40
136. Child-headed household	
137. Unlawful removal or detention of child	
138. Unlawful taking or sending of child out of Republic	
139. Discipline of child	45
140. Child safety at place of entertainment	
141. <u>Child labour and exploitation of child</u> ”;	

(d) by the insertion after “142. Regulations” of the following:

**“CHAPTER 8**

**PREVENTION AND EARLY INTERVENTION**

- |  |    |
|--|----|
| 143. Prevention and early intervention programmes                                    | 5  |
| 144. Purposes of prevention and early intervention programmes                        |    |
| 145. Strategy for securing prevention and early intervention                         |    |
| 146. Provision of prevention and early intervention programmes                       |    |
| 147. Norms and standards for prevention and early intervention programmes            |    |
| 148. Court may order early intervention  |    |
| 149. Report to include summary of prevention and early intervention programmes”; and | 10 |

(e) by the insertion after “166. Change of residence or work by respondent” of the following:

**“CHAPTER 11**

**ALTERNATIVE CARE**

- |   |    |
|---|----|
| 167. Alternative care   |    |
| 168. Leave of absence   |    |
| 169. Child in alternative care prohibited from leaving Republic   |    |
| 170. Child absconding from alternative care                       |    |
| 171. Transfer of child in alternative care                        | 20 |
| 172. Change in residential care programme                         |    |
| 173. Removal of child already in alternative care                 |    |
| 174. Provisional transfer from alternative care                   |    |
| 175. Discharge from alternative care                              |    |
| 176. Remaining in alternative care after reaching age of 18 years | 25 |
| 177. Appeal against and review of certain decisions               |    |
| 178. Death, abuse or serious injury of child in alternative care  |    |
| 179. Regulations  |    |

**CHAPTER 12**

**FOSTER CARE**

- |   |    |
|---|----|
| 180. Foster care  |    |
| 181. Purposes of foster care                                      |    |
| 182. Initial proceedings  |    |
| 183. Prospective foster parent                                    |    |
| 184. Determination of placement of child in foster care           | 35 |
| 185. Number of children to be placed in foster care per household |    |
| 186. Duration of foster care placements                           |    |
| 187. Reunification of child with biological parent                |    |
| 188. Responsibilities and rights of foster parent                 |    |
| 189. Termination of foster care                                   | 40 |
| 190. Regulations  |    |

**CHAPTER 13**

**CHILD AND YOUTH CARE CENTRES**

- |  |    |
|--|----|
| 191. Child and youth care centre   |    |
| 192. Strategy to ensure sufficient provision of child and youth care centres | 45 |
| 193. Provision of child and youth care centres                               |    |
| 194. Norms and standards for child and youth care centres                    |    |



**Part 1****Establishment and registration of child and youth care centre**

195. Establishment of child and youth care centre by organ of state	
196. Existing government children's home, place of safety, secure care facility, school of industry and reform school	5
197. Establishment of child and youth care centre by accredited organisation	
198. Existing registered children's home	
199. Notice of enforcement	
200. Application for registration or renewal of registration	
201. Consideration of application	10
202. Conditional registration	
203. Amendment of registration	
204. Cancellation of registration	
205. Voluntary closure of child and youth care centre	
206. Child in child and youth care centre to be closed	15
207. Appeal against and review of certain decisions	

**Part 2****Operation and management of child and youth care centre**

208. Management board	
209. Manager and staff of child and youth care centre	20
210. Management system	
211. Quality assurance process	

**Part 3****Miscellaneous**

212. Regulations	25
------------------	----

**CHAPTER 14****DROP-IN CENTRES**

213. Drop-in centres	
214. Strategy concerning drop-in centres	
215. Provision of drop-in centres	30
216. Norms and standards for drop-in centres	
217. Drop-in centres to be registered	
218. Notice of enforcement	
219. Application for registration and renewal of registration	
220. Consideration of application	35
221. Conditional registration	
222. Cancellation of registration	
223. Appeal against and review of certain decisions	
224. Record and inspection of and provision for drop-in centres	
225. Assignment of functions to municipality	40
226. Death, abuse or serious injury of child in drop-in centre	
227. <u>Regulations</u>	

## Amendment of section 1 of Act 38 of 2005

## 3. Section 1 of the principal Act is hereby amended—

- (a) by the insertion after the definition of “**adoptive parent**” of the following definitions:
- “**‘alternative care’** means care of a child in accordance with section 167;
- ‘area’**, in relation to—
- (a) a metropolitan or local municipality, means the area for which the municipality has been established; and
- (b) a district municipality, means those parts of the area for which the municipality has been established which do not fall within the area of a local municipality;”;
- (b) by the insertion after the definition of “**child**” of the following definition:
- “**‘child and youth care centre’** means a facility described in section 191(1);”;
- (c) by the insertion after the definition of “**Child Care Act**” of the following definition:
- “**‘child-headed household’** means a household recognised as such in terms of section 136;”;
- (d) by the insertion after the definition of “**clerk of the court**” of the following definitions:
- “**‘cluster foster care scheme’** means a scheme providing for the reception of children in foster care in accordance with a foster care programme operated by—
- (a) a social, religious or other non-governmental organisation; or
- (b) a group of individuals, acting as care-givers of the children, and managed by a provincial department of social development or a designated child protection organisation;”;
- (e) by the insertion after the definition of “**Department**” of the following definitions:
- “**‘designated child protection organisation’** means an organisation designated in terms of section 107 to perform designated child protection services;
- ‘designated child protection service’** means a child protection service referred to in section 106;”;
- (f) by the insertion after the definition of “**divorce court**” of the following definitions:
- “**‘drop-in centre’** means a facility referred to in section 213(2);
- ‘early childhood development programme’** means a programme referred to in section 91(3);
- ‘early childhood development services’** means services referred to in section 91(2);
- ‘early intervention service’** means a service referred to in section 143(1);”;
- (g) by the insertion after the definition of “**family member**” of the following definitions:
- “**‘foster care’** means care of a child as described in section 180(1) and includes foster care in a cluster foster care scheme;
- ‘foster parent’** means a person who has foster care of a child by order of the children’s court, and includes an active member of an organisation operating a cluster foster care scheme and who has been assigned responsibility for the foster care of a child;”;
- (h) by the insertion after the definition of “**mental illness**” of the following definition:
- “**‘midwife’** means a person registered as a midwife under the Nursing Act, 1978 (Act No. 50 of 1978);”;

- (i) by the insertion after the definition of “**Minister**” of the following definition:  
 “**‘municipality’** means a metropolitan, district or local municipality established in terms of section 12 of the Local Government: Municipal Structures Act, 1998 (Act No. 117 of 1998), but to the extent that a municipality may or must implement a provision of this Act in or in relation to an area which falls within the area of both a district municipality and a local municipality, “municipality” in such a provision means the relevant local municipality;”;
- (j) by the insertion after the definition of “**neglect**” of the following definition:  
 “**‘nurse’** means a person registered as a nurse under the Nursing Act, 1978 (Act No. 50 of 1978);”;
- (k) by the insertion after the definition of “**parental responsibilities and rights**” of the following definition:  
 “**‘partial care’** means partial care referred to in section 76;”;
- (l) by the insertion after the definition of “**party**” of the following definition:  
 “**‘permanency plan’** means a documented plan referred to in section 157(1);”;
- (m) by the insertion after the definition of “**presiding officer**” of the following definition:  
 “**‘prevention services’** means services referred to in section 145(2);”;
- (n) by the insertion after the definition of “**psychologist**” of the following definition:  
 “**‘quality assurance process’** means a developmental quality assurance process in terms of which—  
 (a) a team of people connected to a child and youth care centre makes an internal assessment of the centre;  
 (b) a team of people unconnected to the centre conducts an independent assessment of the centre;  
 (c) an organisational development plan for the centre covering matters prescribed by regulation is established by agreement between the teams; and  
 (d) the unconnected team appoints a mentor to oversee implementation of the plan by the management of the centre;”;
- (o) by the insertion after the definition of “**removal of body parts**” of the following definition:  
 “**‘residential care programme’** means a programme described in section 191(2) which is or must be offered at a child and youth care centre;”;
- (p) by the insertion after the definition of “**school**” of the following definition:  
 “**‘secure care’** means the physical containment of children in a safe and healthy environment conducive to addressing behavioural or emotional difficulties;”.

#### Insertion of chapters 5 and 6 in Act 38 of 2005

4. The following chapters are hereby inserted in the principal Act after Chapter 4:

#### “CHAPTER 5

#### PARTIAL CARE

##### Partial care

76. Partial care is provided when a person, whether for or without reward, takes care of more than six children on behalf of their parents or care-givers during specific hours of the day or night, or for a temporary period, by agreement between the parents or care-givers and the provider of the service, but excludes the taking care of a child—

- (a) by a school as part of tuition, training and other activities provided by the school;  
 (b) as a boarder in a school hostel or other residential facility managed as part of a school; or

- (c) by a hospital or other medical facility as part of the treatment provided to the child.

### Strategy concerning partial care

77. (1) The Minister, after consultation with interested persons and the Ministers of Finance, of Health and of Education, must include in the departmental strategy a comprehensive national strategy aimed at ensuring an appropriate spread of partial care facilities throughout the Republic, giving due consideration as provided in section 11 to children with disability or chronic illness.

(2) The MEC must—

- (a) maintain a record of all the registered partial care facilities in the province concerned;
- (b) within the national strategy referred to in subsection (1), provide for a provincial strategy to ensure an appropriate spread of partial care facilities in the province.

(3) The MEC must compile a provincial profile from time to time in order to make the information available that is necessary for the development and review of the strategies referred to in subsections (1) and (2).

### Provision of partial care

78. (1) The MEC for social development of a province may, from money appropriated by the relevant provincial legislature, provide and fund partial care facilities and services for that province, taking into consideration the national and provincial strategies contemplated in section 77.

(2) Such partial care facilities—

- (a) must be managed and maintained in accordance with this Act; and
- (b) must comply with—
- (i) the prescribed norms and standards contemplated in section 79 and such other requirements as may be prescribed;
  - (ii) the structural safety, health and other requirements of the municipality of the area where the partial care facility is situated.

(3) The owner or manager of a partial care facility or provider of a partial care service only qualifies for funding appropriated as contemplated in subsection (1) if it complies with the prescribed norms and standards contemplated in section 79.

### Norms and standards for partial care

79. (1) The Minister must determine national norms and standards by regulation after consultation with interested persons, including local government.

(2) The norms and standards contemplated in subsection (1) must relate to the following:

- (a) A safe environment for the children;
- (b) proper care for sick children or children that fall ill;
- (c) adequate space and ventilation;
- (d) safe drinking water;
- (e) hygienic and adequate toilet facilities;
- (f) safe storage of anything that may be harmful to children;
- (g) access to disposal of refuse services or other adequate means of disposal of refuse generated at the facility;
- (h) a hygienic area for the preparation of food for the children;
- (i) measures for the separation of children of different age groups;
- (j) the drawing up of action plans for emergencies; and
- (j) the drawing up of policies and procedures regarding health care at the centre.

(3) A partial care facility for children with disability and chronic illness must, in addition to the norms and standards contemplated in subsection (1)—

- (a) be accessible to such children;
  - (b) provide facilities that meet the needs of such children; and
  - (c) employ persons that are trained in and provide training to persons employed at the facility on—
    - (i) the needs, health and safety of such children; and
    - (ii) appropriate learning activities and communication strategies for such children.
- (4) A partial care facility may offer such programmes appropriate to the developmental needs of the children in that facility as may be prescribed.

#### **Partial care facility to be registered**

- 80.** (1) Any person may establish or operate a partial care facility provided that the facility—
- (a) is registered with the provincial government of the province where that facility is situated;
  - (b) is managed and maintained in accordance with any conditions subject to which the facility is registered; and
  - (c) complies with the prescribed norms and standards contemplated in section 79 and such other requirements as may be prescribed.
- (2) The Minister by regulation may exempt any person or organisation or any category of person or organisation from the requirement to register on such conditions as may be prescribed.
- (3) (a) Partial care facilities operated or managed by a national or provincial state department must comply with subsection (1).  
 (b) Notwithstanding the provisions of paragraph (a), partial care facilities operated or managed by a national or provincial state department responsible for social development need not comply with subsection (1).
- (4) As from the date on which this section takes effect an existing place of care registered or deemed to be registered in terms of the Child Care Act must be regarded as having been registered in terms of this section as a partial care facility.
- (5) A facility referred to in subsection (4) is regarded to be a registered partial care facility for a period of five years from the date on which that subsection takes effect, unless its registration is withdrawn in terms of section 84 before the expiry of that period.

#### **Application for registration and renewal of registration**

- 81.** (1) An application for registration or conditional registration of a partial care facility or for the reinstatement or renewal of a registration must—
- (a) be lodged with the provincial head of social development of the province where the facility is situated in accordance with a procedure prescribed by regulation;
  - (b) contain the particulars prescribed by regulation; and
  - (c) be accompanied by—
    - (i) a report by a social service professional on the viability of the application; and
    - (ii) any documents that may be prescribed by regulation.
- (2) An applicant must provide such additional information relevant to the application as the provincial head of social development may determine.
- (3) An application for the renewal of registration or conditional registration must be made at least 90 days before the registration is due to expire, but the provincial head of social development may allow a late application on good cause shown.
- (4) The provincial head of social development must renew the registration of a partial care facility before the expiration thereof if the application for renewal was lodged at least 90 days before the registration was due to expire as mentioned in subsection (3).

**Consideration of application**

- 82.** (1) The provincial head of social development must—
- (a) consider an application for registration or conditional registration or for the renewal of a registration and either reject the application or, having regard to subsection (2), grant the registration or renewal with or without conditions; 5
  - (b) issue to the applicant a certificate of registration or conditional registration or renewal of registration in the form prescribed by regulation if the application is granted; and
  - (c) state in the certificate of registration the period for which the registration will remain valid. 10
- (2) When considering an application the provincial head of social development must take into account all relevant factors, including whether—
- (a) the facility complies with the prescribed norms and standards contemplated in section 79 and such other requirements as may be prescribed; 15
  - (b) the applicant is a fit and proper person to operate a partial care facility;
  - (c) the applicant has the necessary funds and resources available to provide the partial care services of the type applied for; 20
  - (d) each person employed at or engaged in the partial care facility is a fit and proper person to assist in operating a partial care facility; and
  - (e) each person employed at or engaged in the partial care facility has the prescribed skills to assist in operating that partial care facility. 25
- (3) A person unsuitable to work with children is not a fit and proper person to operate or assist in operating a partial care facility.
- (4) The provincial head of social development must consider the report contemplated in section 82(1)(c)(i) of a social service professional before deciding an application for registration, conditional registration or renewal of registration. 30
- (5) Notwithstanding the provisions of section 78(3) a provincial head of social development may assist the owner or manager of a partial care facility to comply with the prescribed norms and standards contemplated in section 79 and such other requirements as may be prescribed.

**Conditional registration**

- 83.** The registration or renewal of the registration of a partial care facility may be granted on such conditions as the provincial head of social development may determine, including conditions—
- (a) specifying the type of partial care that may or must be provided in terms of the registration; 40
  - (b) stating the period for which the registration will remain valid; and
  - (c) providing for any other matters that may be prescribed by regulation.

**Cancellation of registration**

- 84.** (1) The provincial head of social development may cancel the registration or conditional registration of a partial care facility by written notice to the registration holder if— 45
- (a) the facility is not maintained in accordance with the prescribed norms and standards contemplated in section 79 and such other requirements as may be prescribed;
  - (b) any condition subject to which the registration or renewal of registration was issued is breached or not complied with; 50
  - (c) the registration holder or the management of the facility contravenes or fails to comply with a provision of this Act;
  - (d) the registration holder becomes a person who is not a fit and proper person to operate a partial care facility; or
  - (e) a person who is not a fit and proper person to assist in operating a partial care facility, is employed at or engaged in operating the facility. 55

(2) The provincial head of social development may in the case of the cancellation of a registration in terms of subsection (1)(a), (b), (c) or (e)—

- (a) suspend the cancellation for a period to allow the registration holder to correct the cause of the cancellation; and
- (b) reinstate the registration if the registration holder corrects the cause of the cancellation within that period.

(3) The provincial head of social development may assist a registration holder to comply with the prescribed norms and standards contemplated in section 79, any requirements as may be prescribed or any provisions of this Act where the cancellation was due to non-compliance with those norms and standards, conditions, requirements or provisions.

#### **Notice of enforcement**

**85.** (1) A provincial head of social development may by way of a written notice of enforcement instruct—

- (a) a person operating an unregistered partial care facility—
  - (i) to stop operating that facility; or
  - (ii) to apply for registration in terms of section 80 within a period specified in the notice; or
- (b) a person operating a registered partial care facility otherwise than in accordance with the provisions of this Act or any conditions subject to which the registration was issued, to comply with those provisions or conditions.

(2) A person operating an unregistered partial care facility and who is instructed in terms of subsection (1)(a)(ii) to apply for registration within a specified period, may, despite the provisions of section 80, continue operating the facility during that period and, if that person applies for registration, until that person's application has been processed.

(3) The Director-General or the provincial head of social development may apply to the High Court for an order to instruct a partial care facility, whether registered or not, to stop operating that facility.

(4) The High Court may grant an order for costs against the owner of manager of the partial care facility referred to in subsection (3) if so requested by the Director-General or provincial head of social development.

#### **Appeal against and review of certain decisions**

**86.** (1) An applicant aggrieved by a decision of a provincial head of social development in terms of section 82 or 83, or a registration holder aggrieved by a decision of a provincial head of social development in terms of section 84, may lodge an appeal against that decision with the MEC for social development.

(2) An applicant that is not satisfied with the outcome of an appeal lodged as referred to in subsection (1) may apply to the competent division of the High Court to review that decision.

#### **Record and inspection of and provision for partial care facility**

**87.** (1) A provincial head of social development must—

- (a) maintain a record of all available partial care facilities in the province, the types of partial care facility and the number of each type of facility;
- (b) compile a profile of the children in that province in the prescribed manner; and
- (c) conduct regular inspections of partial care facilities in the province to enforce the provisions of this Act.

(2) Provincial strategies must include strategies for the provision of partial care facilities in its area, which must include measures—

- (a) facilitating the establishment and operation of sufficient partial care facilities in the province;
- (b) prioritising those types of partial care facilities most urgently required; and

- (c) liaising with municipalities on facilitating the identification and provision of suitable premises.

#### **Assignment of functions to municipality**

**88.** (1) The provincial head of social development may, by written agreement with a municipality, assign the performance of some or all of the functions contemplated in sections 80, 81, 82, 83, 84, 85 and 87 to the municipal manager if the provincial head of social development is satisfied that the municipality complies with the prescribed requirements with regard to the capacity of that municipality to perform the functions concerned.

(2) The agreement must be in the prescribed form and contain the prescribed particulars.

(3) The municipal manager referred to in subsection (1) may delegate any power or duty assigned to him or her in terms of this section to a designated social worker in the employ of the municipality.

(4) A delegation in terms of subsection (2)—

- (a) is subject to any limitations, conditions and directions which the municipal manager may impose;
- (b) must be in writing; and
- (c) does not divest the municipal manager of the responsibility concerning the exercise of the power or the performance of the duty.

(5) The municipal manager may—

- (a) confirm, vary or revoke any decision taken in consequence of a delegation in terms of this section, subject to any rights that may have accrued to a person as a result of the decision; and
- (b) at any time withdraw a delegation.

(6) An applicant aggrieved by a decision of an official in the employ of a municipality with regard to an application for registration or renewal of registration in terms of section 81, the conditions on which registration was granted in terms of section 82, conditional registration in terms of section 83 or a registration holder aggrieved by a decision to cancel the registration of a partial care facility in terms of section 84 may lodge an appeal with the municipal council against that decision.

(7) An applicant that is not satisfied with the outcome of an appeal lodged as contemplated in subsection (6) may apply to the competent division of the High Court to review that decision.

(8) (a) The provincial head of social development must monitor the performance of the functions assigned in terms of this section.

(b) The provincial head of social development may by notice in writing require the municipal manager or any other person in possession of information required by the provincial head of social development for purposes of monitoring the performance of the functions assigned by this section, to provide such information to the provincial head of social development within the period specified in the notice.

(c) If, after the functions contemplated in subsection (1) had been assigned to a municipality, it appears that a particular municipality no longer has the capacity to perform some or all of the functions assigned to it, the provincial head of social development may—

- (i) amend the written agreement contemplated in subsection (1); or
- (ii) withdraw the assignment of the functions.

#### **Death, abuse or serious injury of child in partial care facility**

**89.** (1) If a child dies while in partial care or following an occurrence at a partial care facility, the person operating the partial care facility must immediately after the child's death report such death—

- (a) to a police official;
- (b) the provincial head of social development; and
- (c) the parent or guardian of the child.

(2) The police official must cause an investigation into the circumstances surrounding the death of the child to be conducted by the South African



Police Service if the police official is satisfied that the child did not die of natural causes.

(3) If a child is abused or seriously injured while in partial care or following an occurrence at a partial care facility, the person operating the partial care facility must immediately report such injury or abuse to the provincial head of social development, who must cause an investigation into the circumstances of the abuse or serious injury to be conducted.

### **Regulations**

**90.** The Minister may make regulations in terms of section 306 concerning—

- (a) the norms and standards that partial care facilities must comply with;
- (b) the procedure to be followed in connection with the lodging and consideration of applications for registration in terms of this Chapter, for the renewal of such registration and for the suspension or cancellation of registration;
- (c) the different types of partial care that may be provided in terms of such registration;
- (d) the period for which registration is valid;
- (e) the requirements that the different types of partial care facilities have to comply with;
- (f) the management of partial care facilities;
- (g) the procedure to be followed and the fees to be paid in connection with the lodging and consideration of appeals in terms of this Chapter; and
- (h) any other matter that may be necessary to facilitate the implementation of this Chapter.

## **CHAPTER 6**

### **EARLY CHILDHOOD DEVELOPMENT**

#### **Early childhood development**

**91.** (1) Early childhood development, for the purposes of this Act, means the process of emotional, cognitive, spiritual, moral, physical and social development of children from birth to school-going age.

(2) Early childhood development services means services—

- (a) intended to promote early childhood development; and
- (b) provided by a person, other than a child's parent or caregiver, on a regular basis to children up to school-going age.

(3) An early childhood development programme means a programme structured within an early childhood development service to provide learning and support appropriate to the child's developmental age and stage.

#### **Strategy concerning early childhood development**

**92.** (1) The Minister, after consultation with interested persons, and the Ministers of Education, of Finance and of Health, must include in the departmental strategy a comprehensive national strategy aimed at securing a properly resourced, co-ordinated and managed early childhood development system, giving due consideration as mentioned in section 11 to children with disability or chronic illness.

(2) The MEC must—

- (a) maintain a record of all the early childhood development programmes registered in the province concerned;
- (b) within the national strategy referred to in subsection (1), provide for a provincial strategy aimed at a properly resourced, co-ordinated and managed early childhood development system.

(3) The MEC must compile a provincial profile from time to time in order to make the information available that is necessary for the development and review of the strategies referred to in subsections (1) and (2).

**Provision of early childhood development programmes**

**93.** (1) The MEC for social development of a province may, from money appropriated by the relevant provincial legislature, provide and fund early childhood development programmes for that province.

(2) Early childhood development programmes must—

- (a) be provided in accordance with this Act; and
- (b) comply with the prescribed norms and standards contemplated in section 94 and such other requirements as may be prescribed.

(3) The provider of an early childhood development programme only qualifies for funding appropriated as contemplated in subsection (1) if it complies with the prescribed norms and standards contemplated in section 79.

(4) The funding of early childhood development programmes in communities where families lack the means of providing proper shelter, food and other basic necessities of life to their children must be given priority.

(5) Early childhood development programmes must be provided by—

- (a) a partial care facility providing partial care services for any children up to school-going age; and
- (b) a child and youth care centre which has in its care any children up to school-going age.

(6) Any other person or organisation not disqualified in terms of section 96(3) may provide early childhood development programmes, provided that those programmes comply with the prescribed norms and standards contemplated in section 94 and such other requirements as may be prescribed.

**Norms and standards for early childhood development**

**94.** (1) The Minister must determine national norms and standards by regulation after consultation with interested persons, including the Departments of Education and of Health.

(2) The prescribed norms and standards contemplated in subsection (1) must relate to the following:

- (a) The provision of appropriate developmental opportunities;
- (b) programmes aimed at helping children to realise their full potential;
- (c) caring for children in a constructive manner, providing support and security;
- (d) ensuring development of positive social behaviour;
- (e) respect for and nurturing of the culture, spirit, dignity, individuality, language and development of each child; and
- (f) meeting the emotional, cognitive, spiritual, moral, physical and social development needs of the children.

(3) Early childhood development programmes provided in terms of this section must be appropriate to the needs of the children to whom the services are provided, including children with disabilities, chronic illness and other special needs.

**Early childhood development programme to be registered**

**95.** (1) A person operating or managing a partial care facility or a child and youth care centre where an early childhood development programme is provided must—

- (a) register the programme with the provincial head of social development of the province where that programme is provided;
- (b) provide the programme in accordance with any conditions subject to which the programme is registered; and
- (c) comply with the prescribed norms and standards contemplated in section 94 and such other requirements as may be prescribed.

(2) The Minister by regulation may exempt any person or organisation or any category of person or organisation from the requirement to register on such conditions as may be prescribed.

(3) (a) Early childhood development programmes provided by a national or provincial state department must comply with subsection (1).

(b) Notwithstanding the provisions of paragraph (a), early childhood development programmes provided by a national or provincial state department responsible for social development or education need not comply with subsection (1).

#### **Application for registration and renewal of registration**

**96.** (1) An application for registration or conditional registration of an early childhood development programme or for the renewal of a registration must—

- (a) be lodged with the provincial head of social development of the province where the partial care facility or child and youth care centre is situated in accordance with a procedure prescribed by regulation;
- (b) contain the particulars prescribed by regulation; and
- (c) be accompanied by any documents that may be prescribed by regulation.

(2) An applicant must provide such additional information relevant to the application as the provincial head of social development may determine.

(3) An application for the renewal of registration or conditional registration must be made at least 90 days before the registration is due to expire, but the provincial head of social development may allow a late application on good cause shown.

(4) The provincial head of social development must renew the registration of a partial care facility before the expiration thereof if the application for renewal was lodged at least 90 days before the registration was due to expire as contemplated in subsection (3).

#### **Consideration of application**

**97.** (1) The provincial head of social development must—

- (a) consider an application for registration or conditional registration or for the renewal of a registration, and either reject the application or, having regard to subsection (2), grant the registration or renewal with or without conditions;
- (b) issue to the applicant a certificate of registration or conditional registration or renewal of registration in the form prescribed by regulation, if the application is granted; and
- (c) state in the certificate of registration the period for which the registration will remain valid.

(2) When considering an application, the provincial head of social development must take into account all relevant factors, including whether—

- (a) the early childhood development programme complies with the prescribed norms and standards as contemplated in section 94 and such other requirements as may be prescribed;
- (b) the applicant is a fit and proper person to provide early childhood development services;
- (c) the applicant has the prescribed skills, funds and resources available to provide the early childhood development programme as applied for; and
- (d) the early childhood development programme meets the emotional, cognitive, spiritual, moral, physical and social development needs of the children in that partial care facility or child and youth care centre.

(3) A person unsuitable to work with children is not a fit and proper person to provide or assist in the provision of early childhood development services or programmes.

(4) The provincial head of social development must consider a report of a social service professional before deciding an application for registration, conditional registration or renewal of registration.

(5) Notwithstanding the provisions of section 78(3), a provincial head of social development may assist a partial care facility or a child and youth

care centre providing early childhood development programmes to comply with the prescribed norms and standards contemplated in section 94 and such other requirements as may be prescribed.

#### Conditional registration

98. The registration or renewal of the registration of an early childhood development programme may be granted on such conditions as the provincial head of social development may determine, including conditions—

- (a) specifying the type of early childhood development programme that may or must be provided in terms of the registration;
- (b) stating the period for which the registration will remain valid; and
- (c) providing for any other matters that may be prescribed by regulation.

#### Cancellation of registration

99. (1) A provincial head of social development may cancel the registration or conditional registration of an early childhood development programme by written notice to the registration holder if—

- (a) the programme is not run in accordance with the prescribed norms and standards contemplated in section 94 and such other requirements as may be prescribed;
- (b) any condition subject to which the registration or renewal of registration was issued is breached or not complied with;
- (c) the registration holder contravenes or fails to comply with a provision of this Act;
- (d) the registration holder becomes a person who is not a fit and proper person to provide early childhood development programmes; or
- (e) a person who is not a fit and proper person to provide or assist in the provision of early childhood development programmes provides or assists in the provision of such programmes.

(2) The provincial head of social development may in the case of the cancellation of a registration in terms of subsection (1)(a), (b), (c) or (e)—

- (a) suspend the cancellation for a period to allow the registration holder to correct the cause of the cancellation; and
- (b) reinstate the registration if the registration holder corrects the cause of the cancellation within that period.

(3) A provincial head of social development may assist a registration holder to comply with the prescribed norms and standards contemplated in section 94 and such other requirements as may be prescribed or any provisions of this Act where the cancellation was due to non-compliance with those norms and standards, requirements, conditions or provisions.

(4) The cancellation of the registration or conditional registration of an early childhood development programme in terms of subsection (1) does not affect the registration or conditional registration of a partial care facility or a child and youth care centre.

#### Notice of enforcement

100. A provincial head of social development may by way of a written notice of enforcement instruct—

- (a) the person operating or managing a partial care facility or a child and youth care centre which does not provide an early childhood development programme, to comply with that section within a period specified in the notice;
- (b) the person operating or managing a partial care facility or a child and youth care centre which does provide early childhood development programmes but of a standard that does not comply with the prescribed norms and standards contemplated in section 94 and such other requirements as may be prescribed, to comply with those norms and standards and other requirements within a period specified in the notice; or
- (c) a person who provides an early childhood development programme which does not comply with the prescribed norms and standards

contemplated in section 94 and such other requirements as may be prescribed ]—

- (i) to stop the provision of that programme; or
- (ii) to comply with those norms and standards and other requirements within a period specified in the notice.

5

### **Assessment of early childhood development programmes**

**101.** (1) A provincial head of social development must authorise a suitably qualified person to assess the provision and content of early childhood development programmes, in order to determine whether the programme complies with the prescribed norms and standards contemplated in section 94 and such other requirements as may be prescribed.

10

(2) Section 304(2) and (3), read with such changes as the context may require, applies to any assessment in terms of subsection (1) of this section.

### **Assignment of functions to municipality**

**102.** (1) The provincial head of social development may, by written agreement with a municipality, assign the performance of some or all of the functions contemplated in sections 95, 96, 97, 98, 99, 100 and 101 to the municipal manager if the provincial head of social development is satisfied that the municipality complies with the prescribed requirements with regard to the capacity of that municipality to perform the functions concerned.

15

(2) The agreement must be in the prescribed form and contain the prescribed particulars.

(3) The municipal manager referred to in subsection (1) may delegate any power or duty assigned to him or her in terms of this section to a designated social worker in the employ of the municipality.

25

(4) A delegation in terms of subsection (2)—

- (a) is subject to any limitations, conditions and directions which the municipal manager may impose;
- (b) must be in writing; and
- (c) does not divest the municipal manager of the responsibility concerning the exercise of the power or the performance of the duty.

30

(5) The municipal manager may—

- (a) confirm, vary or revoke any decision taken in consequence of a delegation in terms of this section, subject to any rights that may have accrued to a person as a result of the decision; and
- (b) at any time withdraw a delegation.

35

(6) An applicant aggrieved by a decision of an official in the employ of a municipality with regard to an application for registration or renewal of registration in terms of section 96, the conditions on which registration was granted in terms of section 97, conditional registration in terms of section 98 or a registration holder aggrieved by a decision to cancel the registration of a partial care facility in terms of section 99 may lodge an appeal with the municipal council against that decision.

40

(7) An applicant that is not satisfied with the outcome of an appeal lodged as contemplated in subsection (6), may apply to the competent division of the High Court to review that decision.

45

(8) (a) The provincial head of social development must monitor the performance of the functions assigned in terms of this section.

(b) The provincial head of social development may by notice in writing require the municipal manager or any other person in possession of information required by the provincial head of social development for purposes of monitoring the performance of the functions assigned by this section, to provide such information to the provincial head of social development within the period specified in the notice.

50

(c) If, after the functions contemplated in subsection (1) had been assigned to a municipality, it appears that a particular municipality no longer has the capacity to perform some or all of the functions assigned to it, the provincial head of social development may—

55

- (i) amend the written agreement contemplated in subsection (1);  
or
- (ii) withdraw the assignment of the functions.

### Regulations

- 103.** The Minister may make regulations in terms of section 306 concerning—
- (a) the norms and standards that early childhood development programmes must comply with;
  - (b) any other requirements with which early childhood development programmes must comply;
  - (c) the procedure to be followed in connection with the lodging and consideration of applications for registration in terms of this Chapter and for the renewal of such registrations;
  - (d) the assessment and compulsory monitoring of early childhood development programmes offered at partial care facilities and child and youth care centres; and
  - (d) any other matter necessary to facilitate the implementation of this Chapter.”.

### Amendment of chapter 7 of Act 38 of 2005

- 5.** Chapter 7 of the principal Act is hereby amended—
- (a) by the insertion before Part 2 of the following Part:

#### *“Part 1*

#### *Child protection system*

#### **Strategy concerning child protection**

- 104.** (1) The Minister, after consultation with interested persons, including the Ministers of Education, of Finance, of Health, of Justice and Constitutional Development and the South African Police Service, must develop a comprehensive inter-sectoral strategy aimed at securing a properly resourced, co-ordinated and managed national child protection system.
- (2) The MEC must within the national strategy referred to in subsection (1), provide for a provincial strategy aimed at a properly resourced, co-ordinated and managed child protection system.
- (3) The MEC must compile a provincial profile from time to time in order to make the information available that is necessary for the development and review of the strategies referred to in subsections (1) and (2).

#### **Provision of child protection services**

- 105.** (1) The MEC for social development of a province must, from money appropriated by the relevant provincial legislature, provide and fund child protection services for that province.
- (2) Such child protection services—
- (a) must be management and maintained in accordance with this Act; and
  - (b) must comply with the prescribed norms and standards contemplated in section 106 and such other requirements as may be prescribed.
- (3) Designated child protection services provided by an organ of state or a designated child protection organisation only qualify for funding from money appropriated by a provincial legislature if it complies with the norms and standards mentioned in section 106.
- (4) Designated child protection services may be provided by—
- (a) the Department;
  - (b) a provincial department responsible for social development in a province; and
  - (c) a designated child protection organisation.

- (5) Designated child protection services include—
- (a) services aimed at supporting—
    - (i) the proceedings of children's courts; and
    - (ii) the implementation of court orders;
  - (b) services relating to—
    - (i) prevention services;
    - (ii) early intervention services;
    - (iii) the reunification of children in alternative care with their families;
    - (iv) the integration of children into alternative care arrangements;
    - (v) the placement of children in alternative care; and
    - (vi) the adoption of children, including inter-country adoptions;
  - (c) the carrying out of investigations and the making of assessments, in cases of suspected abuse, neglect or abandonment of children;
  - (d) intervention and removal of children in appropriate cases;
  - (e) the drawing up of individual development plans and permanency plans for children removed, or at risk of being removed, from their family; and
  - (f) any other social work service that may be prescribed by regulation.]

### **Norms and standard concerning child protection**

**106.** (1) The Minister must determine national norms and standards by regulation after consultation with interested persons.

(2) The norms and standards contemplated in subsection (1) must relate to the following:

- (a) Prevention and early intervention programmes;
- (b) assessment;
- (c) therapeutic programmes;
- (d) after care;
- (e) family reunification and reintegration;
- (f) foster care supervision;
- (g) family preservation;
- (h) integration into alternative care;
- (i) adoption;
- (j) permanency plans;
- (k) development;
- (l) education and information;
- (m) outreach;
- (n) support groups;
- (o) preparation programmes; and
- (p) social security.

(3) Child protection services only qualifies for funding from money appropriated by a provincial legislature if it complies with the prescribed norms and standards contemplated in subseas determined by the Minister by regulation.

### **Designation of child protection organisation**

**107.** (1) The Director-General or provincial head of social development on written application may designate any appropriate organisation that complies with the prescribed criteria as a child protection organisation to perform in the relevant province all or any specific designated child protection services.

(2) A designation in terms of subsection (1)—

- (a) must be in writing;
- (b) may be made on such conditions as the Director-General or provincial head may determine; and
- (c) must be made for such period as may be prescribed.

(3) The Director-General or provincial head for social development may delegate to a designated child protection organisation such powers and duties in terms of this Act as may be necessary for the proper provision of designated child protection services by the organisation.

(4) Sections 303 and 304, read with such changes as the context may require, apply to any delegation in terms of subsection (1).

### **Existing child welfare organisation**

**108.** (1) Any organisation which, when section 107 takes effect, was a designated welfare organisation within the meaning of the Child Care Act must be regarded as having been designated in terms of section 107 as a child protection organisation to perform the designated child protection services which it performed immediately before that section took effect.

(2) An organisation referred to in subsection (1) is regarded to be a designated child protection organisation for a period of five years from the date on which section 107 takes effect, unless its designation is withdrawn in terms of section 109 [110] before the expiry of that period.

### **Withdrawal of designation**

**109.** (1) The Director-General or provincial head for social development may withdraw the designation of a child protection organisation to perform any, or any specific, designated child protection service—

(a) if the organisation—

(i) breaches or fails to comply with any conditions subject to which the designation was made;

(ii) contravenes or fails to comply with a provision of this Act; or

(b) if it is in the best interest of the protection of children.

(2) Before the designation of a child protection organisation is withdrawn as contemplated in subsection (1), the Director-General or provincial head for social development, as the case may be, must conduct quality assurance in the prescribed manner of the child protection organisation concerned.

### **Reporting of child in need of care and protection**

**110.** (1) Any correctional official, dentist, homeopath; labour inspector, legal practitioner, medical practitioner, midwife, minister of religion, nurse, occupational therapist, police official, physiotherapist, psychologist, religious leader, social service professional, social worker, speech therapist, teacher, traditional health practitioner, traditional leader or member of staff or volunteer worker at a partial care facility, shelter, drop-in centre or child and youth care centre who on reasonable grounds concludes that a child has been abused in a manner causing physical injury, sexually abused or deliberately neglected, if it is in the best interest of the child concerned, must report that conclusion to a designated child protection organisation or the provincial department of social development.

(2) Any person who on reasonable grounds believes that a child is in need of care and protection because of abuse, sexual abuse or deliberate neglect, may report that belief to the provincial department of social development, a designated child protection organisation or a police official.

(3) A person referred to in subsection (1) or (2)—

(a) must substantiate that conclusion or belief to the provincial department of social development, a designated child protection organisation or police official;

(b) who makes a report in good faith is not liable to civil action on the basis of the report.

(4) A police official to whom a report has been made in terms of subsection (2) must—

(a) within 24 hours ensure the safety and well-being of the child concerned if the child's safety or well-being is at risk; and

(b) notify the provincial department of social development or a designated child protection organisation of the report and any steps that have been taken with regard to the child.



- (5) The provincial department of social development or designated child protection organisation to whom a report has been made in terms of subsection (1), (2) or (4), must—
- (a) ensure the safety and well-being of the child concerned, if the child's safety or well-being is at risk; 5
  - (b) make an initial assessment of the report;
  - (c) submit such particulars concerning the matter as may be prescribed by regulation to the Director-General for inclusion in Part A of the National Child Protection Register; 10
  - (c) unless the report is frivolous or obviously unfounded, investigate the truthfulness of the report or cause it to be investigated; and
  - (d) if the report is substantiated by such investigation, without delay initiate proceedings in terms of this Act for the protection of the child.
- (7) The provincial department of social development or designated child protection organisation who has conducted an investigation as contemplated in subsection (5) may— 15
- (a) take measures to assist the child, including counselling, mediation, prevention and early intervention services, family reconstruction and rehabilitation, behaviour modification, problem solving and referral to another suitably qualified person or organisation; 20
  - (b) if he or she is satisfied that it is in the best interest of the child not to be removed from his or her home or place where he or she resides, but that the removal of the alleged offender from such home or place would secure the safety and well-being of the child, request a police official in the prescribed manner to take the steps referred to in section 153; or 25
  - (c) deal with the child in the manner contemplated in sections 151, 152 or 155.”; 30

- (b) by the insertion after section 134 of the following Part:

**“Part 4** 30

***Other protective measures***

**Applications to terminate or suspend parental responsibilities and rights**

- 135.** (1) The Director-General, a provincial head of social development or a designated child protection organisation may apply to a High Court, or a divorce court in divorce matters or a children's court for an order— 35
- (a) suspending for a period, terminating or transferring any or all of the parental responsibilities and rights which a specific person has in respect of a child; or
  - (b) restricting or circumscribing the exercise by that person of any or all of the parental responsibilities and rights that person has in respect of a child. 40
- (2) An application in terms of subsection (1) may be brought without the consent of a parent or care-giver of the child if the child, at the time of the application— 45
- (a) is older than seven years, and has been in alternative care for more than two years;
  - (b) is older than three years but not older than seven years, and has been in alternative care for more than one year; or
  - (c) is three years or younger, and has been in alternative care for more than six months. 50
- (3) When considering an application the court must be—
- (a) guided by the principles set out in Chapters 2 and 3 to the extent that those principles are applicable to the matter before it; and
  - (b) take into account all relevant factors, including— 55
    - (i) the need for the child to be permanently settled, preferably in a family environment, taking into consideration the age and stage of development of the child;

- (ii) the success or otherwise of any attempts that have been made to reunite the child with the person whose parental responsibilities and rights are challenged;
- (iii) the relationship between the child and that person;
- (iv) the degree of commitment that that person has shown towards the child;
- (v) whether there had been any contact between the parent and the child over the year preceding the application; and
- (v) the probabilities of arranging for the child to be adopted or placed in another form of alternative care.

(4) Section 29, read with such changes as the context may require, applies in respect of any proceedings in terms of this section.

#### **Child-headed household**

**136.** (1) A provincial head of social development may recognise a household as a child-headed household if—

- (a) the parent or care-giver of the household is terminally ill or has died;
- (b) no adult family member is available to provide care for the children in the household;
- (c) a child over the age of 15 years has assumed the role of care-giver in respect of the children in the household;
- (d) the children in the household have been investigated by a social worker as contemplated in section 150(2); and
- (e) it is in the best interest of the children in the household.

(2) A child-headed household must function under the general supervision of an adult designated by—

- (a) a children's court; or
- (b) an organ of state or a non-governmental organisation determined by the provincial head of social development.

(3) The supervising adult must—

- (a) perform the duties as prescribed in relation to the household;
- (b) may not supervise more than 12 children in child-headed households.

(4) (a) The child at the head of the household or the adult contemplated in subsection (2) may collect and administer for the child-headed household any social security grant or other assistance to which the household is entitled.

(b) An adult that collects and administers money for a child-headed household as contemplated in paragraph (a) is accountable in the prescribed manner to the organ of state or the non-governmental organisation that designated him or her to supervise the household.

(5) (a) The organ of state or non-governmental organisation contemplated in subsection (2) may collect and administer for the child-headed household any social security grant or other grant or assistance to which the household is entitled.

(b) An organ of state or non-governmental organisation is accountable to the provincial department of social development or the children's court for the administration of any money received on behalf of the household.

(6) The adult referred to in subsection (2) and the organ of state or non-governmental organisation referred to in subsection (3) may not take any decisions concerning such household and the children in the household without consulting—

- (a) the child at the head of the household; and
- (b) given the age, maturity and stage of development of the other children, also those other children.

(7) The child heading the household may take all day-to-day decisions relating to the household and the children in the household as if that child was an adult care-giver.

(8) A child-headed household may not be excluded from any grant, subsidy, aid, relief or other assistance or programmes for poor households and vulnerable children provided by an organ of state in the national, provincial or local sphere of government solely by reason of the fact that the household is headed by a child.

**Unlawful removal or detention of child**

**137.** (1) No person may without lawful authority or reasonable grounds—

- (a) remove a child from the care of a person who lawfully cares for the child; or
- (b) detain a child with the result that the child is kept out of the care of a person entitled to lawful care of the child.

(2) For the purposes of subsection (1) a person must be regarded as detaining a child if that person—

- (a) causes the child to be detained; or
- (b) induces the child to remain with him or her or any other person.

**Unlawful taking or sending of child out of Republic**

**138.** (1) No person may take or send a child out of the Republic—

- (a) in contravention of an order of a court prohibiting the removal of the child from the Republic; or
- (b) without consent—
  - (i) obtained in terms of section 30(5) from persons holding relevant parental responsibilities and rights in respect of that child;
  - (ii) obtained in terms of section 169 with regard to a child in alternative care; or
  - (ii) of a court.

(2) For the purposes of subsection (1) a person must be regarded as—

- (a) taking a child out of the Republic if that person—
  - (i) causes the child to be taken, or in any way assists in taking the child, out of the Republic; or
  - (ii) causes or induces the child to accompany or to join him or her or any other person when departing from the Republic; or
- (b) sending a child out of the Republic if that person causes the child to be sent, or in any way assists in sending the child, out of the Republic.

**Discipline of children**

**139.** (1) A person who has care of a child, including a person who has parental responsibilities and rights in respect of the child, must respect, promote and protect the child's right to physical and psychological integrity as conferred by section 12(1)(c), (d) and (e) of the Constitution.

(2) No child may be subjected to corporal punishment or be punished in a cruel, inhuman or degrading way.

(3) The common law defence of reasonable chastisement available to persons referred to in subsection (1) in any court proceeding is hereby abolished.

(4) No person may administer corporal punishment to a child or subject a child to any form of cruel, inhuman or degrading punishment at a [any] child and youth care centre, partial care facility or shelter or drop-in centre.

(5) The Department must take all reasonable steps to ensure that—

- (a) education and awareness-raising programmes concerning the effect of subsections (1), (2), (3) and (4) are implemented throughout the Republic; and
- (b) programmes promoting appropriate discipline are available throughout the Republic.

(6) A parent, care-giver or any person holding parental responsibilities and rights in respect of a child who is reported for subjecting such child to inappropriate forms of punishment must be referred to an early intervention service as contemplated in section 144.

(7) Prosecution of a parent or person holding parental responsibilities and rights referred to in subsection (6) may be instituted if the punishment constitutes abuse of the child.

**Child safety at place of entertainment**

**140.** (1) A person providing entertainment to children in any premises or enclosure must comply with subsection (2) if—

- (a) access to the premises or enclosure where the entertainment is provided requires the use of doors, stairs, escalators, lifts or other mechanical means; 5
- (b) the majority of the people attending the entertainment are children; and
- (c) the number of people, including children, who attend the entertainment exceeds 50. 10

(2) A person providing entertainment to children in the circumstances specified in subsection (1) must—

- (a) determine the number of people, including children, who can safely be accommodated in the premises or enclosure and each part of the premises or enclosure; 15
- (b) station a sufficient number of adult attendants to prevent more people, including children, being admitted to the premises or enclosure, or any part of the premises or enclosure, than the number of people determined in terms of paragraph (a) for the premises or enclosure or that part of the premises or enclosure; 20
- (c) control the movement of people admitted to the premises or enclosure, or any part of the premises or enclosure, while entering or leaving the premises or enclosure or that part of the premises or enclosure; and
- (d) take all reasonable precautions for the safety of the children and other people attending the entertainment. 25

(3) No alcohol or tobacco products may be sold, served or made available to children at places of entertainment.

(4) If the person providing the entertainment is not the owner of the premises or enclosure where the entertainment is provided, the owner or the owner's agent must take all reasonable steps to ensure that subsections (2) and (3) are complied with. 30

(5) (a) A person authorised by a municipality in whose area a premises or enclosure is situated where entertainment described in subsection (1) is or is to be provided, or on reasonable suspicion is or is to be provided, may enter such enclosure in order to inspect whether subsections (2) or (3) are complied with. 35

(b) Section 297(2) and (3), read with such changes as the context may require, applies to any inspection in terms of paragraph (a) of this subsection. 40

**Child labour and exploitation of children**

**141.** (1) No person may—

- (a) employ a child contrary to the provisions of the Basic Conditions of Employment Act, 1997 (Act No. 75 of 1997);
- (b) use, procure, offer or employ a child for purposes of commercial sexual exploitation; 45
- (c) use, procure, offer or employ a child for illicit activities, including drug production and trafficking; or
- (d) use, procure, offer or employ a child for child labour;

(2) A social worker or social service professional who becomes aware of instances of child labour or contraventions of the provisions of the Basic Conditions of Employment Act, 1997 must report it to the Department of Labour." 50

**Amendment of section 142 of Act 38 of 2005**

6. Section 142 of the principal Act is hereby amended by the insertion in subsection (1) before paragraph (g) of the following paragraphs:

- “(a) prescribing criteria for determining organisations which may be designated as child protection organisations; 5
- (b) prescribing norms and standards and codes of good practice to guide designated child protection organisations, organs of state and social workers involved in the provision of designated child protection services; 10
- (c) prescribing a broad risk assessment framework to guide decision-making in the provision of designated child protection services; 10
- (d) prescribing— 15
- (i) criteria for determining suitable persons who may conduct investigations into cases of alleged child abuse or neglect; and
- (ii) the powers and responsibilities of persons contemplated in subparagraph (i); 15
- (e) prescribing the conditions for the examination or assessment of children who have been abused or neglected, including the consent of the child for any such examination or assessment given the age and maturity of the child; 20
- (f) prohibiting or regulating cultural and religious practices violating the physical integrity of children;”.

**Insertion of chapter 8 in Act 38 of 2005**

7. The following chapter is hereby inserted in the principal Act after Chapter 7:

**“CHAPTER 8****PREVENTION AND EARLY INTERVENTION** 25**Prevention and early intervention programmes**

- 143.** (1) Early intervention programmes means programmes—
- (a) designed to serve the purposes mentioned in section 144; and
- (b) provided to families where there are children identified as being vulnerable to or at risk of harm or removal into alternative care; 30
- (2) Prevention programmes means programmes—
- (a) designed to serve the purposes mentioned in section 144; and
- (b) provided to families with children in order to strengthen and build their capacity and self-reliance to address problems that may or are bound to occur in the family environment which, if not attended to, may lead to statutory intervention. 35

**Purposes of prevention and early intervention programmes**

- 144.** (1) Prevention and early intervention programmes must focus on:
- (a) Preserving a child’s family structure;
- (b) developing appropriate parenting skills and the capacity of parents and care-givers to safeguard the well-being and best interests of their children; 40
- (c) establishing appropriate interpersonal relationships within the family;
- (d) promoting the well-being of children and the realisation of their full potential; 45
- (e) providing psychological, rehabilitation and therapeutic programmes for children;
- (f) preventing the neglect, abuse or inadequate supervision of children and preventing other failures in the family environment to meet children’s needs; 50
- (g) preventing the recurrence of problems in the family environment that may harm children or adversely affect their development;
- (h) diverting children away from the child and youth care system and the criminal justice system; and

- (i) avoiding the removal of a child from the family environment.
- (2) Prevention and early intervention programmes may include—
  - (a) assisting families to obtain the basic necessities of life;
  - (b) empowering families to obtain such necessities for themselves.
- (3) Prevention and early intervention programmes must involve and promote the participation of families, parents, care-givers and children in identifying and seeking solutions to their problems.

#### **Strategy for securing prevention and early intervention**

- 145.** (1) The Minister, after consultation with the relevant interested persons, including the Ministers of Education, of Finance and of Health, must include in the departmental strategy a comprehensive national strategy aimed at securing the provision of prevention and early intervention services to families, parents, care-givers and children across the country.
- (2) The MEC must within the national strategy referred to in subsection (1) provide for a provincial strategy aimed at properly resourced, co-ordinated and managed prevention and early intervention.
- (3) The MEC must compile a provincial profile from time to time in order to make the information available that is necessary for the development and review of the strategies referred to in subsections (1) and (2).

#### **Provision of prevention and early intervention services**

- 146.** (1) The MEC for social development of a province may, from money appropriated by the relevant provincial legislature, provide and fund prevention and early intervention programmes for that province.
- (2) Prevention and early intervention programmes must—
  - (a) be provided in accordance with this Act; and
  - (b) comply with the norms and standards prescribed by the Minister.
- (3) The provider of prevention and early intervention programmes only qualifies for funding appropriated as contemplated in subsection (1) if the programmes comply with the prescribed norms and standards mentioned in section 147.
- (4) In implementing prevention and early intervention programmes families who lack the means of providing proper shelter, food and other basic necessities of life to their children must be given priority.

#### **Norms and standards for prevention and early intervention programmes**

- 147.** (1) The Minister must determine national norms and standards by regulation after consultation with interested persons, including the Departments of Education and of Health.
- (2) The norms and standards contemplated in subsection (1) must relate to the following:
  - (a) Outreach;
  - (b) education, information and promotion;
  - (c) therapeutic programmes;
  - (d) family preservation;
  - (e) skills development programmes;
  - (f) diversion programmes;
  - (g) protection;
  - (h) temporary safe care;
  - (i) assessment;
  - (j) social security;
  - (k) family participation; and
  - (l) empowerment.
- (3) Prevention and early intervention programmes only qualify for funding from money appropriated by a provincial legislature if it complies with the norms and standards as determined by the Minister by regulation.

**Court may order early intervention**

**148.** (1) Before making an order concerning the temporary or permanent removal of a child from that child's family environment, a children's court may order—

- (a) the provincial department of social development, a designated child protection organisation, any other relevant organ of state or any other person or organisation to provide early intervention programmes in respect of the child and the family or parent or care-giver of the child if the court considers the provision of such programmes appropriate in the circumstances;
- (b) the child's family and the child to participate in a prescribed family preservation programme.

(2) An order made in terms of subsection (1) must be for a specified period not exceeding six months.

(3) When a case resumes after the expiry of the specified period, a designated social worker's report setting out progress with early intervention programmes provided to the child and the family, parent or care-giver of the child, must be submitted to the court.

(4) After considering the report, the court may—

- (a) decide the question whether the child should be removed; or
- (b) order the continuation of the early intervention programme for a further specified period not exceeding six months.

(5) Subsection (1) does not apply where the safety or well-being of the child is seriously and imminently at risk.

**Report to include summary of prevention and early intervention programmes**

**149.** When a report of a designated social worker is produced before a court in order to assist a court in determining a matter concerning a child, the report must contain a summary of any prevention and early intervention programmes provided in respect of that child and the family, parent or care-giver of the child.”.

**Amendment of section 156 of Act 38 of 2005**

**8.** Section 156 of the principal Act is hereby amended by the insertion in subsection (1) after paragraph (e) of the following paragraph:

“(f) if the child lives in a child-headed household, that the child must remain in that household subject to section 136;”.

**Insertion of chapters 11, 12, 13 and 14 in Act 38 of 2005**

**9.** The following chapters are hereby inserted in the principal Act after Chapter 10:

**“CHAPTER 11****ALTERNATIVE CARE****Alternative care**

**167.** (1) A child is in alternative care if the child has been placed—

- (a) in foster care;
- (b) in the care of a child and youth care centre following an order of a court in terms of this Act or the Criminal Procedure Act, 1977 (Act No. 51 of 1977); or
- (c) in temporary safe care.

(2) A child may not be cared for, kept or retained at a facility or a place other than a registered child and youth care centre or in foster care for longer than the prescribed period without a court order placing the child in alternative care.

(3) (a) The head of social development must approve a person, facility, place or premises for temporary safe care in the prescribed manner.

(b) A person, facility, place or premises for temporary safe care must comply with the prescribed criteria.

#### **Leave of absence**

**168.** (1) Leave of absence may, subject to subsection (2) and such limitations and conditions as may be prescribed by regulation, be granted to a child in alternative care—

(a) by the management of a child and youth care centre in whose care the child has been placed;

(b) by the person in whose alternative care the child has been placed; and

(c) by the head of social development in the relevant province, in the case of a child in temporary safe care.

(2) If a child has been placed in alternative care under the supervision of a designated social worker, leave of absence may only be granted with the approval of that social worker.

(3) The management, person referred to in subsection (1), designated social worker or the head of social development in the province may at any time cancel any leave of absence granted in terms of subsection (1).

(4) In the case of foster care, the supervising designated social worker may at any time cancel any leave of absence granted in terms of subsection (1).

(5) When a child's leave of absence has been cancelled, the management, person referred to in subsection (1), designated social worker or the head of social development must request the child to return to the child and youth care centre or person, or to the place where the child is in temporary safe care.

#### **Child in alternative care prohibited from leaving Republic**

**169.** (1) A child in alternative care may not leave the Republic without the written approval of the provincial head of social development first being obtained.

(2) In granting approval in terms on subsection (1), the provincial head of social development may prescribe any terms and conditions to protect the best interest of the child in alternative care.

#### **Child absconding from alternative care**

**170.** (1) Any police official or designated social worker may apprehend a child in alternative care who—

(a) has absconded from the child and youth care centre or person in whose foster care or temporary safe care that child has been placed; or

(b) has been granted leave of absence by the child and youth care centre or person in whose foster care or temporary safe care that child has been placed and who on cancellation or expiration of such leave of absence fails to return to that centre or person.

(2) If a police official or designated social worker contemplated in subsection (1) has reasonable grounds to believe that a child is in or on certain premises, the police official or designated social worker may, without a warrant, enter and search the premises for the purpose of apprehending the child.

(3) A police official referred to in subsection (1) may use such force as may be reasonably necessary to overcome any resistance against the entry or search of the premises as contemplated in subsection (1), including the breaking of any door or window of such premises: Provided that the police official shall first audibly demand admission to the premises and notify the purpose for which he or she seeks to enter such premises.

(4) On apprehending a child in alternative care who has absconded or failed to return in terms of subsection (1), the police official must ensure the safety and well-being of the child concerned, if the child's safety or



well-being is at risk, and notify the provincial department of social development or a designated child protection organisation of the fact the child has been apprehended and of any steps that have been taken with regard to the child.

(5) A child so apprehended or a child who returns, of his or her own accord, to the centre or person in whose alternative care he or she was before absconding— 5

(a) must without delay be brought before a presiding officer of a children's court; and

(b) may, until brought before a presiding officer of a children's court, be kept in temporary safe care in terms of section 152. 10

(6) When the child is brought before a presiding officer of a children's court, the presiding officer must—

(a) order that the child be put in the temporary safe care of a child and youth care centre or appropriate facility or person determined by the presiding officer and kept there until the proceedings in terms of this section are completed and any order made or action taken in terms of this section is given effect to; 15

(b) inquire into the reasons why the child absconded from, or failed to return to, the relevant child and youth care centre or person, and may for this purpose question the child; and 20

(c) order that the child—

(i) be returned to that centre or person;

(ii) may not be returned to that centre or person pending any action by the provincial head of social development in the relevant province in terms of subsection (8), if the presiding officer is of the opinion that there are good reasons why the child should not be returned to that centre or person; or 25

(iii) be placed in another form of alternative care.

(7) The presiding officer of the children's court must order the clerk of the children's court to— 30

(a) report to the provincial head of social development in the relevant province the result of an inquiry in terms of subsection (6); and

(b) notify the provincial head of any order made in terms of subsection (6) (c). 35

(8) When an order has been made in terms of subsection (6)(c)(ii) the provincial head may, after consideration of the report of the children's court and such inquiry as the provincial head may consider necessary—

(a) transfer the child in terms of section 171;

(b) remove the child from alternative care in terms of section 173; 40

(c) discharge the child from alternative care in terms of section 175; or

(d) order that the child be returned to the child and youth care centre or person in whose care or temporary safe care that child has been placed.

### **Transfer of child in alternative care**

**171.** (1) The provincial head of social development in the relevant province may, subject to subsection (5), by order in writing transfer a child in alternative care from the child and youth care centre or person in whose care or temporary safe care that child has been placed to any other child and youth care centre or person. 45

(2) The provincial head may not transfer a child to a child and youth care centre in another province without the permission of the provincial head of social development in that other province and without the prescribed financial arrangements regarding the placement being made. 50

(3) (a) If the provincial head transfers a child in terms of subsection (1) to the care of the child's parent, guardian or former care-giver under the supervision of a designated social worker, the order must specify the requirements with which the child and that parent, guardian or former care-giver must comply. 55

(b) If any requirement referred to in paragraph (a) is breached or not complied with, the designated social worker concerned may bring the child 60

before a children's court, which may, after an inquiry, vary the order issued by the provincial head or make a new order in terms of section 156.

(4) Before the provincial head issues an order in terms of subsection (1), a designated social worker must consult—

- (a) the child;
- (b) the parent or primary care-giver of the child, if available;
- (c) the child and youth care centre or person in whose care or temporary safe care that child has been placed; and
- (d) the child and youth care centre or person to whom the child is to be transferred.

(5) If the provincial head transfers a child from a secure care child and youth care centre to a less restrictive child and youth care centre or to the care of a person, the provincial head must be satisfied that the transfer will not be prejudicial to other children.

(6) No order in terms of subsection (1) may be carried out without ratification by a children's court if the child is transferred—

- (a) from the care of a person to a child and youth care centre; or
- (b) from the care of a child and youth care centre to a secure care or more restrictive child and youth care centre.

### **Change in residential care programme**

**172.** (1) The provincial head of social development in the relevant province may, subject to subsection (3), determine that—

- (a) a child in a child and youth care centre be released from a residential care programme;
- (b) another residential care programme be applied to such a child; or
- (c) an additional residential care programme be applied to such a child.

(2) To give effect to subsection (1), the provincial head may transfer the child to another child and youth care centre or to a person in terms of section 171.

(3) No determination in terms of subsection (1) may be carried out without ratification by a children's court if that determination requires the application to the child of a residential care programme—

- (a) which includes the secure care of the child; or
- (b) which is more restrictive than the child's current programme.

### **Removal of child already in alternative care**

**173.** (1) The provincial head of social development in the relevant province may, in the best interest of a child at any time whilst the child is in alternative care, issue a notice directing that the child, pending any action in terms of subsection (3)—

- (a) be removed from the child and youth care centre or person in whose care or temporary safe care the child is; and
- (b) be put in temporary safe care at a place specified in the notice.

(2) The provincial head must, within six months from the date on which a child has been moved and put in temporary safe care in terms of subsection (1) and after such inquiry as the provincial head may consider necessary—

- (a) transfer the child in terms of section 171;
- (b) discharge the child from alternative care in terms of section 175; or
- (c) issue a notice directing that the child be returned to the child and youth care centre or person in whose care or temporary care the child was immediately before the subsection (1) notice was issued.

### **Provisional transfer from alternative care**

**174.** (1) A provincial head of social development may, in the best interest of a child at any time whilst the child is in alternative care, issue a notice directing that the child be provisionally transferred from alternative care into another form of care that is not more restrictive, as from a date specified in the notice, for a trial period of not more than six months.

- (2) A notice of provisional transfer in terms of subsection (1) may be issued only after—
- (a) procedures prescribed by regulation have been followed—
    - (i) to assess the best interest of the child; and
    - (ii) to reunite the child with the child's immediate family or other family members, if applicable; and
  - (b) a report on such assessment and reunification has been submitted to and considered by the provincial head of social development.
- (3) Provisional transfer must be managed by a designated social worker to establish the feasibility of—
- (a) reunification of the child with the child's immediate family or other family members;
  - (b) integration into another family; or
  - (c) a transfer to another child and youth care centre of any other form of placement.
- (4) The provincial head—
- (a) must revoke the transfer if the child so requests and the social worker so recommends; and
  - (b) may at the end of or at any time during the trial period confirm the child's placement or permanently discharge the child from alternative care in terms of section 175.
- (5) The notice of provisional transfer shall be considered proof of eligibility for any form of state support which would have been payable if the transfer had been permanent.

#### **Discharge from alternative care**

- 175.** (1) The provincial head of social development in the relevant province may, in the best interest of a child at any time whilst the child is in alternative care, issue a notice directing that the child be discharged from alternative care as from a date specified in the notice.
- (2) A notice of discharge in terms of subsection (1) may be issued only after—
- (a) procedures prescribed by regulation have been carried out—
    - (i) to assess the best interest of the child; and
    - (ii) to reunite the child with the child's immediate family or other family members, if applicable; and
  - (b) a report on such assessment and reunification by a designated social worker has been submitted to and considered by the provincial head of social development.
- (3) A notice of discharge relieves the alternate care-giver from any further responsibilities in relation to the child.

#### **Remaining in alternative care after reaching age of 18 years**

- 176.** (1) A person placed in alternative care as a child is entitled, after having reached the age of 18 years, to remain in that care until the end of the year in which that person reached the age of 18 years.
- (2) A provincial head of social development may on application by a person placed in alternative care as a child, allow that person to remain in that care until the end of the year in which that person reaches the age of 21 years if—
- (a) the current alternative care-giver is willing and able to care for that person; and
  - (b) the continued stay in that care is necessary to enable that person to complete his or her education or training.

#### **Appeal against and review of certain decisions 177.**

- (1) A child or person aggrieved by a decision in terms of section 168 or a decision or action in terms of section 170(8), 171, 172, 173, 174, 175, or 176 may lodge an appeal with the MEC against that decision.

(2) An applicant that is not satisfied with the outcome of an appeal lodged as contemplated in subsection (1), may apply to the competent division of the High Court to review that decision.

#### **Death, abuse or serious injury of child in alternative care 178.**

(1) If a child in alternative care dies, the management of the child and youth care centre or person in whose care or foster care the child has been placed must immediately after the child's death report such death—

- (a) to a police official;
- (b) the provincial head of social development;
- (c) the parent or guardian of the child, if he or she can be traced; and
- (d) the social worker dealing with the matter.

(2) The police official must cause an investigation into the circumstances surrounding the death of the child to be conducted by the South African Police Service if the police official is satisfied that the child did not die of natural causes.

(3) If a child in alternative care is abused or seriously injured, the management of the child and youth care centre or person in whose care the child has been placed must immediately report the matter to the provincial head of social development who must cause an investigation into the circumstances of the abuse or serious injury to be conducted.

#### **Regulations**

**179.** The Minister, after consultation with the Minister for Justice and Constitutional Development where court orders are regulated, may make regulations in terms of section 306 prescribing—

- (a) the manner in which a person, facility, place or premises for temporary safe care must be approved;
- (b) the criteria that a person, facility, place or premises for temporary safe care must comply with;
- (c) limitations or conditions for leave of absence from alternative care;
- (d) the manner in which children in alternative care must be transferred or provisionally transferred, their residential care programmes changed, be removed or permanently discharged from alternative care;
- (e) fees payable to a child and youth care centre on transfer or provisional transfer of a child in alternative care to that centre;
- (f) the manner in which applications for extension of alternative care beyond 18 years of age are to be made; and
- (g) any other matter that may be necessary to facilitate the implementation of this Chapter.

## **CHAPTER 12**

### **FOSTER CARE**

#### **Foster care**

**180.** (1) A child is in foster care if the child has been placed in the care of a person who is not the parent or guardian of the child as a result of—

- (a) an order of a children's court; or
- (b) a transfer in terms of section 171.

(2) Foster care excludes the placement of a child—

- (a) in temporary safe care; or
- (b) in the care of a child and youth care centre.

(3) A children's court may place a child in foster care—

- (a) with a person who is not a family member of the child;
- (b) with a family member who is not the parent or guardian of the child; or
- (c) in a cluster foster care scheme.

**Purposes of foster care**

**181.** The purposes of foster care are to—

- (a) protect and nurture children by providing a safe, healthy environment with positive support;
- (b) promote the goals of permanency planning, first towards family reunification, or by connecting children to other safe and nurturing family relationships intended to last a lifetime; and
- (c) respect the individual and family by demonstrating a respect for cultural, ethnic and community diversity.

5

**Initial proceedings**

10

**182.** Before a children's court places a child in foster care, the court must follow the children's court processes stipulated in Part 2 of Chapter 10 to the extent that the provisions of that Part are applicable to the particular case.

**Prospective foster parent**

15

**183.** (1) A prospective foster parent must be—

- (a) a fit and proper person to be entrusted with the foster care of the child;
- (b) willing and able to undertake, exercise and maintain the responsibilities of such care; and
- (c) properly assessed by a designated social worker for compliance with paragraphs (a) and (b).

20

(2) A person unsuitable to work with children is not a fit and proper person to be entrusted with the foster care of a child.

(3) Subsections (1) and (2), read with such changes as the context may require, apply to any organisation or a group of individuals managing a cluster foster care scheme.

25

**Determination of placement of child in foster care**

**184.** (1) Before a children's court places a child in foster care by court order in terms of section 156, the court must consider a report by a designated social worker about—

30

- (a) the cultural, religious and linguistic background of the child; and
- (b) the availability of a suitable person with a similar background to that of the child who is willing and able to provide foster care to the child.

(2) A child may be placed in the foster care of a person from a different cultural, religious and linguistic background to that of the child, but only if—

35

- (a) there is an existing bond between that person and the child; or
- (b) a suitable and willing person with a similar background is not readily available to provide foster care to the child.

**Number of children to be placed in foster care per household**

40

**185.** (1) Not more than six children may be placed in foster care with a single person or two persons sharing a common household, except where—

- (a) the children are siblings or blood relations; or
- (b) the court considers this for any other reason to be in the best interest of all the children.

45

(2) More than six children may be placed in foster care in terms of a cluster foster care scheme as prescribed.

**Duration of foster care placements**

**186.** (1) A children's court may, despite the provisions of section 159(1)(a) regarding the duration of a court order, after a child has been in foster care with a person other than a family member for more than two

50

years and after having considered the need for creating stability in the child's life, order that—

- (a) no further social worker supervision is required for that placement;
- (b) no further social worker reports are required in respect of that placement; and
- (c) the foster care placement subsists until the child turns 18 years, unless otherwise directed.

(2) A children's court may, despite the provisions of section 159(1)(a) regarding the duration of a court order and after having considered the need for creating stability in the child's life, place a child in foster care with a family member for more than two years, extend such an order for more than two years at a time or order that the foster care placement subsists until the child turns 18 years, if—

- (a) the child has been abandoned by the biological parents;
- (b) the child's biological parents are deceased;
- (c) there is for any other reason no purpose in attempting reunification between the child and the child's biological parents; and
- (d) it is in the best interest of the child.

(3) Despite the provisions of subsections (2) and (3), a social service professional must visit a child in foster care at least once every two years to evaluate the placement.

#### **Reunification of child with biological parent**

**187.** (1) If a children's court placing a child in foster care is of the view that reunification between the child and the child's biological parents is possible and in the best interest of the child, the court must issue the placement order subject to conditions providing for a designated social worker to facilitate such reunification as contemplated in section 156(3)(a).

(2) If the child has not been reunited with the child's biological parents two months before the expiry of the initial court order or any extension of the order, the designated social worker appointed to facilitate the reunification must submit a report to the children's court—

- (a) explaining why the child was not reunited with the biological parents; and
- (b) recommending any steps that may be taken to stabilise the child's life.

(3) The children's court considering the report may—

- (a) order that the designated social worker must continue facilitating the reunification; or
- (b) order the termination of the reunification services if there are no prospects of reunification.

#### **Responsibilities and rights of foster parent**

**188.** (1) The foster parent of a child has those parental responsibilities and rights in respect of the child as set out in—

- (a) the order of the children's court placing the child in the foster care of that foster parent;
- (b) the responsibilities and rights of foster parents as may be prescribed;
- (c) an order of the children's court amending the initial order;
- (d) an order of court assigning parental responsibilities and rights in terms of section 23;
- (e) a parenting plan between the parent or guardian of the child and the foster parent in terms of section 33;
- (f) any applicable provisions of this Act.

(2) An order of the children's court may give parental rights and responsibilities to a foster parent in addition to those normally necessary for a foster parent if—

- (a) the child has been abandoned;
- (b) the child is an orphan; or
- (c) family reunification is not in the best interest of the child.

(3) A children's court may in terms of section 65 monitor the suitability of the placement of a child in foster care.

**Termination of foster care**

**189.** (1) Foster care may be terminated by a children's court if it is in the best interest of the child.

(2) Before terminating the foster care of a child, the court must take into account all relevant factors, including—

- (a) the bond that exists between the child and the child's biological parent, if the biological parent reclaims care of the child;
- (b) the bond that developed between—
  - (i) the child and the foster parent; and
  - (ii) the child and the family of the foster parent; and
- (c) the prospects of achieving permanency in the child's life by—
  - (i) returning the child to the biological parent;
  - (ii) allowing the child to remain permanently in foster care with the foster parent;
  - (iii) placing the child in any other alternative care; or
  - (iv) adoption of the child.

**Regulations**

**190.** The Minister, after consultation with the Minister for Justice and Constitutional Development where court orders are regulated, may make regulations in terms of section 306—

- (a) prescribing the responsibilities and rights of foster parents;
- (b) regulating the establishment, functioning and management of cluster foster care schemes;
- (c) prescribing the requirements with which cluster foster care schemes and any foster care programmes provided in terms of such schemes, must comply; and
- (d) prescribing any other matter that may be necessary to facilitate the implementation of this Chapter.

**CHAPTER 13****CHILD AND YOUTH CARE CENTRES****Child and youth care centre**

**191.** (1) A child and youth care centre is a facility for the provision of residential care to more than six children outside the child's family environment in accordance with a residential care programme or programmes suited for the children in the facility, but excludes—

- (a) a partial care facility;
- (b) a drop-in centre;
- (c) a boarding school;
- (d) a school hostel or other residential facility attached to a school;
- (e) a prison; or
- (f) any other establishment which is maintained mainly for the tuition or training of children other than an establishment which is maintained for children ordered by a court to receive tuition or training.

(2) A child and youth care centre must offer a therapeutic programme designed for the residential care of children outside the family environment, which may include a programme designed for—

- (a) the reception, care and development of children otherwise than in their family environment;
- (b) the reception, care and development of children on a shared basis with the parent or other person having parental responsibilities;
- (c) the reception and temporary safe care of children pending their placement;
- (d) the reception and temporary safe care of children to protect them from abuse or neglect;
- (e) the reception and temporary safe care of trafficked or commercially sexually exploited children;

- (f) the reception and temporary safe care of children for the purpose of—
    - (i) observing and assessing those children;
    - (ii) providing counselling and other treatment to them; or
    - (iii) assisting them to reintegrate with their families and the community;
  - (g) the reception, development and secure care of children awaiting trial or sentence;
  - (h) the reception, development and secure care of children with behavioural, psychological and emotional difficulties;
  - (i) the reception, development and secure care of children in terms of an order—
    - (i) under the Criminal Procedure Act, 1977 (Act No. 51 of 1977);
    - (ii) in terms of section 156(1)(h) placing the child in a child and youth care centre which provides a secure care programme; or
    - (iii) in terms of section 171 transferring a child in alternative care;
  - (j) the reception and care of street children; or
  - (k) the reception and care of children for any other purpose that may be prescribed by regulation.
- (3) A child and youth care centre may in addition to its residential care programmes, offer—
- (a) the provision of appropriate care and development of children with disabilities or chronic illnesses;
  - (b) therapeutic programmes;
  - (c) the treatment of children for addiction to dependence-producing substances;
  - (d) a programme for the treatment of children with a psychiatric condition;
  - (e) a programme to assist a person with the transition when leaving a child and youth care centre after reaching the age of 18; or
  - (f) any other service that may be prescribed by regulation.

#### **Strategy to ensure sufficient provision of child and youth care centres**

**192.** (1) The Minister, after consultation with the Ministers of Education, of Health and of Justice and Constitutional Development, must include in the departmental strategy a comprehensive national strategy aimed at ensuring an appropriate spread of child and youth care centres throughout the Republic providing the required range of residential care programmes in the various regions, giving due consideration as provided in section 11 to children with disability or chronic illness.

(2) The MEC must within the national strategy referred to in subsection (1) provide for a provincial strategy aimed at the establishment of an appropriate spread in the province of properly resourced, co-ordinated and managed child and youth care centres providing the required range of residential care programmes.

(3) The MEC must compile a provincial profile from time to time in order to make the information available that is necessary for the development and review of the strategies referred to in subsections (1) and (2).

(4) The provincial head of social development must maintain a record of all available child and youth care centres in the province concerned and of the programmes contemplated in section 191 offered by each centre.

#### **Provision of child and youth care centres 193.**

(1) The MEC for social development of a province must, from money appropriated by the relevant provincial legislature, provide and fund child and youth care centres for that province.

(2) Such child and youth care centres—

- (a) must be managed and maintained in accordance with this Act; and
- (b) must comply with—
  - (i) the prescribed norms and standards contemplated in section 194 and such other requirements as may be prescribed;



- (ii) the structural, safety, health and other requirements of the municipality of the area in which the child and youth care centre is situated.

(3) An accredited organisation operating a child and youth care centre only qualifies for funding from money appropriated by a provincial legislature if it complies with the norms and standards as determined by the Minister by regulation.

#### **Norms and standards for child and youth care centres**

**194.** (1) The Minister must determine national norms and standards by regulation after consultation with interested persons.

(2) The norms and standards contemplated in subsection (1) must relate to the following:

- (a) A residential care programme;
- (b) therapeutic programmes;
- (c) development programmes;
- (d) permanency plans for children;
- (e) individual development plans;
- (f) temporary safe care;
- (g) protection from abuse and neglect;
- (h) assessment of children;
- (i) family reunification and reintegration;
- (j) after-care with the purpose of prevention and early intervention;
- (k) access to and provision of adequate health care;
- (l) access to schooling and education; and
- (m) measures for the separation of children in secure care programmes from children in other programmes.

#### ***Part 1***

#### ***Establishment and registration of child and youth care centre***

##### **Establishment of child and youth care centre by organ of state**

**195.** The MEC for social development of a province must, from money appropriated by the relevant provincial legislature, establish and operate child and youth care centres for that province.

##### **Existing government children's home, place of safety, secure care facility, school of industry and reform school**

- 196.** (1) As from the date on which section 195 takes effect—
- (a) an existing state operated children's home established or deemed to have been established in terms of the Child Care Act must be regarded as having been established in terms of section 195 as a child and youth care centre providing a residential care programme referred to in section 191(2)(a);
  - (b) an existing state operated place of safety established or deemed to have been established in terms of the Child Care Act must be regarded as having been established in terms of section 195 as a child and youth care centre providing residential care programmes referred to in section 191(2)(c) and (d);
  - (c) an existing state operated secure care facility established or deemed to have been established in terms of the Child Care Act must be regarded as having been established in terms of section 195 as a child and youth care centre providing a residential care programme referred to in section 191(2)(g);
  - (d) a government industrial school established in terms of section 33 of the Children's Protection Act, 1913 (Act No. 25 of 1913) must be regarded as having been established in terms of section 195 as a child and youth care centre providing a residential care programme referred to in section 191(2)(h);

(e) a reformatory established in terms of section 52 of the Prisons and Reformatories Act, 1911 (Act No. 13 of 1911) must be regarded as having been established in terms of section 195 as a child and youth care centre providing a residential care programme referred to in section 191(2)(i).

(3) The provincial department of education must provide education to the children in the facilities mentioned in paragraphs (d) and (e).

#### **Establishment of child and youth care centre by accredited organisation**

**197.** (1) Any accredited organisation may establish or operate a child and youth care centre provided that the centre—

- (a) is registered with the relevant provincial department of social development;
- (b) is managed and maintained in accordance with this Act and any conditions subject to which the centre is registered;
- (c) complies with the prescribed norms and standards for child and youth care centres as contemplated in section 194 and such other requirements as may be prescribed; and
- (d) complies with the structural, safety, health and other requirements of the municipality of the area in which the child and youth care centre is or is to be situated.

(2) Subsection (1) also applies to a child and youth care centre established by an organ of state in terms of section 195 if the centre is operated by an accredited organisation.

(3) With the exception of partial care facilities operated or managed by a national or provincial state department responsible for social development, all partial care facilities operated or managed by a national or provincial state department must comply with subsection (1).

#### **Existing registered children's home and registered shelter**

**199.** (1) As from the date on which section 197 takes effect an existing privately operated children's home registered or deemed to be registered in terms of the Child Care Act must be regarded as having been registered in terms of section 196 as a child and youth care centre providing a residential care programme mentioned in section 191(2)(a).

(2) A children's home referred to in subsection (1) is regarded to be a registered child and youth care centre for a period of five years from the date on which that subsection takes effect, unless its registration is withdrawn in terms of section 204 before the expiry of that period.

(3) An existing shelter registered in terms of the Child Care Act must register as a child and youth care centre within a period of five years from the date on which this section takes effect.

#### **Notice of enforcement**

**199.** (1) A provincial head of social development may by way of a written notice of enforcement instruct—

- (a) a person or organisation operating an unregistered child and youth care centre—
  - (i) to stop operating that centre; or
  - (ii) to apply for registration in terms of section 199 within a period specified in the notice; or
- (b) a person or organisation operating a registered child and youth care centre otherwise than in accordance with the provisions of this Act or any conditions subject to which the registration was issued, to comply with those provisions or conditions.

(2) A person or organisation operating an unregistered child and youth care centre and who is instructed in terms of subsection (1)(a)(ii) to apply for registration within a specified period may, despite the provisions of section 196 regarding the establishment of child and youth care centres by

accredited organisations, be given permission by the provincial head of social development to continue operating the centre during that period and, if that person applies for registration, until that person's application has been finalised.

(3) The Director-General or the provincial head of social development may apply to the High Court for an order to instruct a person or organisation operating a child and youth care centre, whether registered or not, to stop operating that centre.

(4) The High Court may grant an order for costs against the person or organisation referred to in subsection (3) if so requested by the Director-General or provincial head of social development.

#### **Application for registration or renewal of registration**

**200.** (1) An application for registration of a child and youth care centre established by an accredited organisation as referred to in section 196 or for the renewal of such a registration must—

- (a) be lodged with the provincial head of social development in the relevant province in accordance with a procedure prescribed by regulation;
- (b) contain the particulars prescribed by regulation; and
- (c) be accompanied by—
  - (i) a certified copy of the constitution or founding document of the child and youth care centre;
  - (ii) a certificate issued by the municipality in which the child and youth care centre is or is to be situated certifying that the premises in which the centre is or is to be accommodated complies with all structural, safety, health and other requirements of the municipality; and
  - (iii) any documents that may be prescribed by regulation.

(2) An applicant must provide such additional information relevant to the application as the provincial head of social development may determine.

(3) An application for the renewal of registration must be made at least 90 days before the registration is due to expire, but the provincial head of social development may allow a late application on good cause shown.

(4) The provincial head of social development must renew the registration of a partial care facility before the expiration thereof if the application for renewal was lodged at least 90 days before the registration was due to expire as contemplated in subsection (3).

#### **Consideration of application**

**201.** (1) The provincial head of social development must—

- (a) consider an application for registration or for the renewal of a registration and either refuse the application or grant the registration or renewal with or without conditions, having regard to subsection (2);
- (b) issue to the applicant a certificate of registration or renewal of registration in the form prescribed by regulation if the application is granted; and
- (c) state in the certificate of registration the period for which the registration will remain valid.

(2) When deciding an application the provincial head of social development must take into account all relevant factors, including whether—

- (a) the child and youth care centre complies with—
  - (i) the prescribed norms and standards for child and youth care centres contemplated in section 194 and such other requirements as may be prescribed; and
  - (ii) the structural, safety, health and other requirements of the municipality in which the child and youth care centre is or is to be situated;
- (b) the applicant is a fit and proper person to operate a child and youth care centre;

- (c) the applicant has the necessary skills, funds and resources available to operate the child and youth care centre;
  - (d) each person employed at or engaged in the child and youth care centre is a fit and proper person to assist in operating a child and youth care centre; and
  - (e) each person employed at or engaged in the child and youth care centre has the prescribed skills to assist in operating a child and youth care centre.
- (3) A person unsuitable to work with children is not a fit and proper person to operate or assist in operating a child and youth care centre.
- (4) The provincial head of social development must consider a report of a designated social worker before deciding an application for registration or renewal of registration.
- (5) Notwithstanding the provisions of section 193(3) a provincial head of social development may assist the person or organisation operating a child and youth care centre to comply with the prescribed norms and standards contemplated in section 194 and such other requirements as may be prescribed.

### **Conditional registration**

**202.** The registration or renewal of the registration of a child and youth care centre may be granted on such conditions as the provincial head of social development may determine, including conditions—

- (a) specifying the type of residential care programme or programmes that may or must be provided in terms of the registration;
- (b) stating the period for which the registration will remain valid; and
- (c) providing for any other matters that may be prescribed by regulation.

### **Amendment of registration**

**203.** The provincial head of social development in the relevant province may, on application in the prescribed circumstances by the holder of a registration of a child and youth care centre, amend the registration by written notice to that person.

### **Cancellation of registration**

**204.** (1) The provincial head of social development in the relevant province may cancel the registration of a child and youth care centre by written notice to the registration holder if—

- (a) the centre is not maintained in accordance with—
  - (i) the prescribed norms and standards contemplated in section 194 for child and youth care centres and such other requirements as may be prescribed;
  - (ii) any structural, safety, health and other requirements of the municipality in which the child and youth care centre is situated;
  - (iii) any organisational development plan established for the centre as part of the quality assurance process in terms of section 211; or
  - (iv) any other requirements of this Act;
- (b) any condition subject to which the registration or renewal of registration was issued is breached;
- (c) the registration holder or the management of the centre contravenes or fails to comply with a provision of this Act;
- (d) the registration holder becomes a person who is not a fit and proper person to operate a child and youth care centre; or
- (e) a person who is not a fit and proper person to assist in operating a child and youth care centre is employed at or involved in activities at the centre.

(2) A person unsuitable to work with children is not a fit and proper person to operate or assist in operating a child and youth care centre.

(3) The provincial head of social development may in the case of the cancellation of a registration in terms of subsection (1)(a), (b), (c) or (e)—

- (a) suspend the cancellation for a period to allow the registration holder to correct the cause of the cancellation; and
- (b) reinstate the registration if the registration holder corrects the cause of the cancellation within that period.

(4) The Director-General or a provincial head of social development may assist a registration holder to comply with—

- (a) the prescribed norms and standards for child and youth care centres contemplated in section 194 and such other requirements as may be prescribed;
- (b) any structural, safety, health and other requirements of the municipality in which the child and youth care centre is situated; or
- (c) any provisions of the organisational development plan established for the centre in terms of the quality assurance process contemplated in section 211, where the cancellation was due to a failure to comply with those norms and standards, requirements or process.

(5) The cancellation of a registration which has not been suspended takes effect from a date specified in the notice referred to in subsection (1), which may not be earlier than 90 days from the date on which that notice was given, except if—

- (a) the provincial head of social development and the holder of the registration agree on an earlier date; or
- (b) the safety or protection of the children in the centre requires an earlier date.

#### **Voluntary closure of child and youth care centre**

**205.** (1) The holder of a registration of a child and youth care centre may close the centre by—

- (a) giving written notice to the provincial head of social development in the relevant province; and
- (b) surrendering the certificate of registration to the provincial head of social development for cancellation.

#### **Child in child and youth care centre to be closed**

**206.** (1) If a child and youth care centre is to be closed as a result of the cancellation of its registration in terms of section 204 or voluntary closure of the centre in terms of section 205 every child placed in that centre must be transferred in terms of section 171.

#### **Appeal against and review of certain decisions**

**207.** (1) An applicant aggrieved by a decision of a provincial head of social development with regard to the consideration of an application for registration or renewal of registration in terms of section 200, or the conditions on which registration was granted in terms of section 201, or a registration holder aggrieved by a decision of a provincial head of social development to cancel the registration of a child and youth care centre in terms of section 204, may lodge an appeal against that decision with the MEC for social development.

(2) An applicant that is not satisfied with the outcome of an appeal lodged as contemplated in subsection (1), may apply to the competent division of the High Court to review that decision.

*Part 2***Operation and management of child and youth care centre****Management board**

- 208.** (1) Each child and youth care centre must have a management board consisting of no fewer than six and no more than nine members. 5
- (2) The members of a management board are appointed by—
- (a) the MEC for social development in the relevant province in accordance with a procedure prescribed by regulation, in the case of a child and youth care centre which is operated by the province; and
  - (b) the registration holder in accordance with a procedure prescribed by regulation, in the case of a privately operated child and youth care centre. 10
- (3) In appointing members of the management board, equitable representation by all stakeholders, including the community in which the child and youth care centre is located, must be ensured. 15
- (4) No person unsuitable to work with children may be appointed or continue to serve as a member of a management board.
- (5) A management board functions in terms of the regulations, and may exercise the powers and must perform the duties conferred on it in terms of this Act. 20
- (6) The management board must create a children's forum as part of the management board to ensure the participation of resident children in the operation of the centre.

**Manager and staff of child and youth care centre**

- 209.** (1) The person or organisation operating a child and youth care centre must appoint or designate— 25
- (a) a person as the manager of the centre; and
  - (b) a sufficient number of staff or other appropriate persons to assist in operating the centre.
- (2) A person may be appointed or designated in terms of subsection (1) only— 30
- (a) after following an interview process prescribed by regulation;
  - (b) if that person has the skills and training as prescribed; and
  - (c) if that is a fit and proper person to assist in operating a child and youth care centre. 35
- (3) A person unsuitable to work with children is not a fit and proper person to assist in operating or serving at a child and youth care centre.
- (4) The number of staff appointed or designated must be in accordance with any staff-to-children ratios that may be— 40
- (a) prescribed by regulation; or
  - (b) required in the conditions of registration of the centre.

**Management system**

- 210.** A child and youth care centre must be managed—
- (a) in accordance with— 45
    - (i) a system of management that allows for a division of responsibilities between the management board and the manager of the centre and an appropriate interaction in the exercise of those responsibilities, as may be prescribed by regulation;
    - (ii) the organisational development plan established for the centre in terms of its quality assurance process; and
    - (iii) any other requirements of this Act; and
  - (b) in a manner that is conducive to implementing the residential care programme and other programmes offered at the centre. 50

**Quality assurance process**

**211.** (1) The provincial head for social development must ensure that a quality assurance process is carried out in respect of each child and youth care centre in the manner and at the intervals as prescribed.

(2) The management board of a child and youth care centre must without delay, after completion of the quality assurance process, submit a copy of the organisational development plan established for the centre in terms of the quality assurance process to the MEC for social development in the province.

(3) A provincial head of social development may give advice to a child and youth care centre on carrying out the quality assurance process as contemplated in subsection (1).

**Part 3****Miscellaneous****Regulations**

**212.** The Minister may, where appropriate after consultation with the Ministers of Education, of Health and of Justice and Constitutional Development, in terms of section 306 make regulations prescribing—

- (a) the procedure to be followed in connection with the lodging and consideration of—
  - (i) applications for registration of child and youth care centres;
  - (ii) applications for renewal or amendment of such registrations; and
  - (iii) objections to applications made in terms of sub-paragraphs (i) and (ii);
- (b) the norms and standards that child and youth care centres must comply with;
- (c) the matters with which applicants must comply before, during or after the lodging of their applications;
- (d) consultation processes that must be followed in connection with such applications;
- (e) any additional factors that must be taken into account when deciding such applications;
- (f) the procedure to be followed and the fees to be paid in connection with the lodging and consideration of appeals in terms of this Chapter;
- (g) the format and contents of registration certificates;
- (h) methods and procedures to enforce compliance with registration conditions;
- (i) matters in connection with the physical attributes, operation and management of child and youth care centres;
- (j) matters in connection with residential care programmes provided at child and youth care centres, including the setting of criteria for—
  - (i) the core components of such programmes; and
  - (ii) the implementation of such programmes;
- (k) the provision of programmes at child and youth care centres to meet the developmental, therapeutic and recreational needs of children;
- (l) an assessment of and the formulation of an individual developmental and permanency plan for each child;
- (m) the powers and duties of the management boards of child and youth care centres;
- (n) the composition of management boards, which may include representation for staff and residents;
- (o) matters relating to members of management boards, including—
  - (i) appointment procedures;
  - (ii) qualifications for membership;
  - (iii) term of office;
  - (iv) filling of vacancies; and
  - (v) suspension or termination of membership;

- (p) matters relating to the functioning of management boards, including—
  - (i) designation and functions of presiding members;
  - (ii) the convening and conduct of meetings;
  - (iii) quorums; and
  - (iv) the appointment and functioning of committees of a board;
- (q) matters relating to training, qualifications and experience of staff of child and youth care centres;
- (r) matters relating to the responsibilities of and interaction between the management board and the staff and residents of a child and youth care centre;
- (s) the reporting responsibilities of management boards and staff to the department, person or organisation operating the child and youth care centre;
- (t) the format of the constitution or founding document of a child and youth care centre and the matters to be regulated in such constitution or founding document;
- (u) the rights of children in child and youth care centres;
- (v) management, disciplinary and other practices in child and youth care centres;
- (w) matters in connection with quality assurance processes and organisational development plans established in terms of such processes for child and youth care centres, including—
  - (i) the composition of teams to conduct internal and independent assessments;
  - (ii) the qualifications of team members and the remuneration payable to members of independent teams;
  - (iii) the manner in which internal and independent assessments must be conducted;
  - (iv) the core components of organisational development plans;
  - (v) the implementation, revision and amendment of such plans;
  - (vi) the monitoring of implementation and reporting of violations of such plans; and
  - (vii) the qualifications, functions and remuneration of mentors appointed to oversee the implementation of such plans; and
- (x) any other matter that may facilitate the implementation of this Chapter.

## CHAPTER 14

### DROP-IN CENTRES

#### Drop-in centres

**213.** A drop-in centre is a facility located at a specific place which is managed for the purpose of providing basic services, excluding overnight accommodation, to children, including street children, who voluntarily attend the facility but who are free to leave.

#### Strategy concerning drop-in centres

**214.** (1) The Minister, after consultation with civil society and the relevant interested parties, including the Ministers of Finance and Health, must include in the departmental strategy a strategy aimed at ensuring an appropriate spread of drop-in centres throughout the Republic, giving due consideration as provided in section 11 to children with disability or chronic illness.

(2) The MEC must—

- (a) maintain a record of all the registered drop-in centres in the province concerned;
- (b) within the national strategy referred to in subsection (1), provide for a provincial strategy to ensure an appropriate spread of drop-in centres in the province.



(3) The MEC must compile a provincial profile from time to time in order to make the information available that is necessary for the development and review of the strategies referred to in subsections (1) and (2).

### Provision of drop-in centres

**215.** (1) The MEC for social development of a province may, from money appropriated by the relevant provincial legislature, provide and fund drop-in centres for that province.

(2) Such drop-in centres—

(a) must be management and maintained in accordance with this Act; and  
(b) must comply with—

(i)

the prescribed norms and standards contemplated in section 216 and such other requirements as may be prescribed;

(ii)

the structural safety, health and other requirements of the municipality of the area where the drop-in centre is situated.

(3) The owner or manager of a drop-in centre only qualifies for funding appropriated as contemplated in subsection (1) if the centre complies with the prescribed norms and standards contemplated in section 216 and such other requirements as may be prescribed.

### Norms and standards for drop-in centres

**216.** (1) The Minister must determine norms and standards by regulation after consultation with interested persons, including local government.

(2) The norms and standards contemplated in subsection (1) must relate to the following:

(a) A safe environment for the children;

(b) adequate space and ventilation;

(c) safe drinking water;

(d) hygienic and adequate toilet facilities;

(e) access to disposal of refuse services or other adequate means of disposal of refuse generated at the shelter or drop-in centre;

(f) a hygienic area for the preparation of food for the children.

(g) providing adequate care for the children.

(h) providing programmes in life and social skills, as well as psychosocial services, education, primary health care and recreation.

(i) reporting of all children residing the drop-in centres to a social worker for intervention and family reunification.

(j) drop-in centres should not be seen as a permanent or long term placement.

(k) drop-in centres should have screened and trained staff and care givers.

(l) shelters and drop-in centres should have management committees.

(3) A drop-in centre only qualifies for funding from money appropriated by a provincial legislature if it complies with the prescribed norms and standards as contemplated in section 216 and such other requirements as may be prescribed.

(4) A drop-in centre may offer such programmes appropriate to the developmental needs of the children in that centre as may be prescribed.

### Drop-in centres to be registered

**217.** (1) Any person or organisation may establish or operate a drop-in centre provided that the drop-in centre—

(a) is registered with the provincial head of social development of the province where that drop-in centre is situated;

(b) is managed and maintained in accordance with any conditions subject to which the drop-in centre is registered; and

(c) complies with—

- (i) the prescribed norms and standards for drop-in centres contemplated in section 216 and such other requirements as may be prescribed; and
- (ii) the structural, safety, health and other requirements of the municipality.

(2) As from the date on which this section takes effect an existing drop-in centre registered in terms of the Child Care Act must be regarded as having been registered as a drop-in centre in terms of this section.

(3) A drop-in centre referred to in subsection (4) is regarded to be a registered drop-in centre for a period of five years from the date on which that subsection takes effect, unless its registration is withdrawn in terms of section 84 before the expiry of that period.

#### **Notice of enforcement**

**218.** (1) The provincial head of social development may by way of a written notice of enforcement instruct—

- (a) a person or organisation operating an unregistered drop-in centre—
  - (i) to stop operating that drop-in centre; or
  - (ii) to apply for registration in terms of section 217 within a period specified in the notice; or
- (b) a person or organisation operating a registered drop-in centre otherwise than in accordance with the conditions subject to which the registration was issued, to comply with those conditions.

(2) A person or organisation operating an unregistered drop-in centre and who is instructed in terms of subsection (1)(a)(ii) to apply for registration within a specified period may, despite the provisions of section 217 be given permission by the provincial head of social development to continue operating the drop-in centre during that period and, if that person applies for registration, until that person's application has been finalised.

(3) The Director-General or the provincial head of social development may apply to the High Court for an order to instruct a drop-in centre, whether registered or not, to stop operating that centre.

(4) The High Court may grant an order for costs against the owner of manager of the drop-in care centre referred to in subsection (3) if so requested by the Director-General or provincial head of social development.

#### **Application for registration and renewal of registration**

**219.** (1) An application for registration or conditional registration of a drop-in centre or for the renewal of a registration must—

- (a) be lodged, in accordance with a procedure prescribed by regulation, with the provincial head of social development in which the facility is or will be situated;
- (b) contain the particulars prescribed by regulation; and
- (c) be accompanied by any documents that may be prescribed by regulation;

(2) An applicant must provide such additional information relevant to the application as the provincial head of social development may determine.

(3) An application for the renewal of registration must be made at least 90 days before the registration is due to expire, but the provincial head of social development may allow a late application on good cause shown.

(4) The provincial head of social development must renew the registration of a drop-in centre before the expiration thereof if the application for renewal was lodged at least 90 days before the registration was due to expire as contemplated in subsection (3).

#### **Consideration of application**

**220.** (1) The provincial head of social development must—

- (a) consider an application for registration or conditional registration or for the renewal of a registration, and either reject the application or

- grant the registration or renewal with or without conditions, having regard to subsection (2); and
- (b) issue to the applicant a certificate of registration, conditional registration or renewal of registration on a form prescribed by regulation if the application is granted. 5
- (2) When considering an application, the provincial head of social development must take into account all relevant factors, including whether—
- (a) the drop-in centre complies with— 10
- (i) the prescribed norms and standards for drop-in centres contemplated in section 216; and
- (ii) the structural, safety, health and other requirements of the municipality;
- (b) the applicant is a fit and proper person to operate a drop-in centre;
- (c) the applicant has the necessary skills, funds and resources available to operate the drop-in centre; 15
- (d) each person employed or engaged in the drop-in centre is a fit and proper person to assist in operating a drop-in centre; and
- (e) each person employed at or engaged in the drop-in centre has the prescribed skills to assist in operating a drop-in centre. 20
- (3) A person unsuitable to work with children is not a fit and proper person to operate or assist in operating a drop-in centre.
- (4) The provincial head of social development must consider a report of a social service professional before deciding an application for registration, conditional registration or renewal of registration. 25
- (5) Notwithstanding the provisions of section 215(3) a provincial head of social development may assist the person or organisation operating a drop-in centre to comply with the prescribed norms and standards contemplated in section 216 and such other requirements as may be prescribed. 30

### Conditional registration

- 221.** (1) The registration or renewal of the registration of a drop-in centre may be granted on such conditions as the provincial head of social development may determine, including conditions— 35
- (a) specifying the type of services that may or must be provided in terms of the registration;
- (b) stating the period for which the registration will remain valid; and
- (c) providing for any other matters that may be prescribed by regulation.
- (2) A provincial head of social development may give advice to a drop-in centre on complying with the prescribed norms and standards contemplated in section 216 and such other requirements as may be prescribed. 40

### Cancellation of registration

- 222.** (1) A provincial head of social development may cancel the registration of a drop-in centre by written notice to the registration holder if— 45
- (a) the drop-in centre is not maintained in accordance with—
- (i) the prescribed norms and standards for drop-in centres contemplated in section 216 and such other requirements as may be prescribed; and
- (ii) any other requirements of this Act; 50
- (b) any condition subject to which the registration or renewal of registration was issued is breached or not complied with;
- (c) the registration holder or the management of the drop-in centre contravenes or fails to comply with any provision of this Act;
- (d) the registration holder becomes a person who is not a fit and proper person to operate a drop-in centre; or 55
- (e) a person who is not a fit and proper person to assist in operating a drop-in centre is employed at or engaged in operating the shelter or drop-in centre.

(2) A person unsuitable to work with children is not a fit and proper person to operate or assist in operating a drop-in centre.

(3) The provincial head of social development may in the case of the cancellation of a registration in terms of subsection (1)(a), (b), (c) or (e)—

- (a) suspend the cancellation for a period to allow the registration holder to correct the cause of the cancellation; and
- (b) reinstate the registration if the registration holder corrects the cause of the cancellation within that period.

(4) A provincial head of social development may assist a registration holder to comply with the prescribed norms and standards for drop-in centres contemplated in section 216 and such other requirements as may be prescribed.

### **Appeal against and review of certain decisions**

**223.** (1) An applicant aggrieved by a decision of a provincial head of social development with regard to the consideration of an application for registration, conditional registration or renewal of registration in terms of section 219, or the conditions on which registration was granted in terms of section 221, or a registration holder aggrieved by a decision of a provincial head of social development to cancel the registration of a drop-in centre in terms of section 222 may lodge an appeal with the MEC for social development against that decision.

(2) An applicant that is not satisfied with the outcome of an appeal lodged as contemplated in subsection (1), may apply to the competent division of the High Court to review that decision.

### **Record and inspection of and provision for drop-in centres**

**224.** (1) A provincial head of social development must—

- (a) maintain a record of all available drop-in centres in its area; and
- (b) conduct regular inspections of drop-in centres in the province in collaboration with the municipality where the drop-in centres are situated to enforce the provisions of this Act.

(2) A province's strategies must include strategies for the provision of drop-in centres in the province, which must include measures—

- (a) facilitating the establishment of sufficient drop-in centres in the province;
- (b) prioritising those types of drop-in centres most urgently required; and
- (c) facilitating the identification and provision of suitable premises.

### **Assignment of functions to municipality**

**225.** (1) The provincial head of social development may, by written agreement with a municipality, assign the performance of some or all of the functions contemplated in sections 215, 217, 218, 219, 221 and 222 to the municipal manager if the provincial head of social development is satisfied that the municipality complies with the prescribed requirements with regard to the capacity of that municipality to perform the functions concerned.

(2) The agreement must be in the prescribed form and contain the prescribed particulars.

(3) The municipal manager referred to in subsection (1) may delegate any power or duty assigned to him or her in terms of this section to a designated social worker in the employ of the municipality.

(4) A delegation in terms of subsection (2)—

- (a) is subject to any limitations, conditions and directions which the municipal manager may impose;
- (b) must be in writing; and
- (c) does not divest the municipal manager of the responsibility concerning the exercise of the power or the performance of the duty.

(5) The municipal manager may—

- (a) confirm, vary or revoke any decision taken in consequence of a delegation in terms of this section, subject to any rights that may have accrued to a person as a result of the decision; and
- (b) at any time withdraw a delegation.

(6) An applicant aggrieved by a decision of an official in the employ of a municipality with regard to the consideration of an application for registration, conditional registration or renewal of registration in terms of section 220, or the conditions on which registration was granted in terms of section 221, or a registration holder aggrieved by a decision of a provincial head of social development to cancel the registration of a partial care facility in terms of section 222 may lodge an appeal with the municipal council against that decision.

(7) An applicant that is not satisfied with the outcome of an appeal lodged as contemplated in subsection (6), may apply to the competent division of the High Court to review that decision.

(8) (a) The provincial head of social development must monitor the performance of the functions assigned in terms of this section.

(b) The provincial head of social development may by notice in writing require the municipal manager or any other person in possession of information required by the provincial head of social development for purposes of monitoring the performance of the functions assigned by this section, to provide such information to the provincial head of social development within the period specified in the notice.

(c) If, after the functions contemplated in subsection (1) had been assigned to a municipality, it appears that a particular municipality no longer has the capacity to perform some or all of the functions assigned to it, the provincial head of social development may—

- (i) amend the written agreement contemplated in subsection (1); or
- (ii) withdraw the assignment of the functions.

### **Death, abuse or serious injury of child in drop-in centre**

**226.** (1) If a child is seriously injured or abused while in a drop-in centre or following an occurrence at a drop-in centre, the person operating the drop-in centre must immediately report such injury or abuse to the provincial head of social development.

(2) The provincial head of social development must cause the serious injury or abuse of the child to be investigated.

(3) If a child dies while in partial care or following an occurrence at a drop-in centre, the person operating the drop-in centre must immediately after the child's death report such death to a police official and the provincial head of social development.

(4) The police official must investigate the circumstances of the death of such child.

### **Regulations**

**227.** The Minister, after consultation with the Minister of Justice and Constitutional Development where review of decisions by the courts are regulated, may make regulations in terms of section 306 concerning—

- (a) the procedure to be followed in connection with the lodging and consideration of applications for registration in terms of this Chapter and for the renewal of registration;
- (b) the different services that may be provided in terms of such registrations;
- (c) the procedure to be followed and the fees to be paid in connection with the lodging and consideration of appeals in terms of this Chapter;
- (d) the management of drop-in centres;
- (e) any other matter that may be necessary to facilitate the implementation of this Chapter.”.

**Amendment of section 250 of Act 38 of 2005**

10. Section 250 of the principal Act is hereby amended by the insertion after subsection (2) of the following subsection:

“(3) A welfare organisation referred to in section 108 which was lawfully engaged in providing adoption services when this section took effect may, despite the provisions of subsection (1), continue with such services for a period of two years without being accredited in terms of section 251 to provide adoption services, but must within that period apply for such accreditation in terms of section 251.” 5

**Amendment of section 304 of Act 38 of 2005**

11. Section 304 of the principal Act is hereby amended by the insertion before subparagraph (iii) of paragraph (a) of subsection (3) of the following subparagraphs: 10

“(i) the prescribed norms and standards referred to in section 83, 209 or 220 applicable to it;  
(ii) other norms and standards as may be prescribed by regulation;”.

**Amendment of section 305 of Act 38 of 2005**

12. Section 305 of the principal Act is hereby amended— 15

(a) by the substitution for paragraph (c) of subsection (1) of the following paragraph:

“(a) fails to comply with section 12(5), 12(9), 57(2), 110(1), 124, 126(1), 134(1) or 232(6);” 20

(b) by the insertion after paragraph (d) of subsection (1) of the following paragraphs:

“(e) misappropriates money for which that person is accountable in terms of section 136(3);

(f) fails to comply with section 78(1), 95(1), 196(1) or 215(1) after that person has been instructed by way of a notice of enforcement in terms of section 80, 99, 198 or 217 to comply with the relevant section;

(g) fails to stop operating an unregistered child and youth care centre, partial care facility or drop-in centre after that person has been instructed by way of a notice of enforcement in terms of section 80, 198 or 217 to stop operating that child and youth care centre, partial care facility or drop-in centre; 30

(h) fails to stop providing early childhood development services after that person has been instructed by way of a notice of enforcement in terms of section 99 to stop providing those services; 35

(i) directly or indirectly counsels, induces or aids any child to whom leave of absence has been granted in terms of section 168 not to return to the child and youth care centre or person in whose care or temporary safe care that child has been placed, or prevents the child from returning to that centre or person after the expiration of the period of leave or after the cancellation of such leave; 40

(j) remove a child in alternative care from the Republic without the prior written approval for such removal first being obtained in terms of section 169;” 45

**Short title and commencement**

13. This Act is called the Children’s Amendment Act, 2006, and takes effect on a date fixed by the President by proclamation in the *Gazette*.

## **MEMORANDUM ON THE OBJECTS OF THE CHILDREN'S AMENDMENT BILL, 2006**

### **LEGAL-TECHNICAL BACKGROUND OF THE BILL**

This Amendment Bill contains part of the envisaged Children's Act. The Bill that was initially submitted to Parliament (the "consolidated Bill") dealt with the full spectrum of protection of children in both national and provincial spheres and was to be dealt with in terms of section 76 of the Constitution of the Republic of South Africa Act, 1996 (functional area of concurrent national and provincial legislative competence). It was later found to be a "mixed" Bill, including elements to be dealt with in terms of both section 75 (functional area of national legislative competence) and section 76 of the Constitution.

Due to its mixed character, the Deputy Speaker of the National Assembly requested the Executive to split the consolidated Bill, which was subsequently done. The provisions of the consolidated Bill that will apply to the national government was passed by Parliament during 2005 as the Children's Act, No. 38 of 2005. The provisions of the consolidated Bill that will apply to the provincial government is contained in the current Amendment Bill as an amendment to the Children's Act, 2005 (the "Children's Act"). This Amendment Bill will be dealt with in terms of section 76 of the Constitution and will complete the Children's Act by inserting the provisions that deal with welfare services as delivered by the provinces.

### **GENERAL BACKGROUND AND OVERVIEW**

The lives of children are affected by various pieces of legislation and international conventions. Apart from section 28 of the Constitution, which deals with the rights of children specifically, some of the statutes pertaining to children currently on the statute book are the following:

- The Age of Majority Act, 1972 (Act No. 57 of 1972)
- The Child Care Act 1960 (Act No. 74 of 1983)
- Children's Status Act, 1987 (Act No. 82 of 1987)
- Guardianship Act, 1993 (Act No. 192 of 1993)
- Hague Convention on the Civil Aspects of International Child Abduction Act, 1996 (Act No. 72 of 1996)
- Natural Fathers of Children born out of Wedlock Act, 1997 (Act No. 86 of 1997)

Over the past few years, it has become clear that existing legislation is not in keeping with the realities of current social problems and no longer protects children adequately. In addition thereto, the Republic of South Africa has acceded to various international conventions, such as the United Nations Declaration on the Rights of the Child and the African Charter on the Rights and Welfare of the Child, the principles of which have to be incorporated into local legislation.

During 1997 the Minister for Social Development requested the South African Law Reform Commission to investigate the Child Care Act, 1983 and to make recommendations to the Minister for the reform of this particular branch of the law. After an extensive process of research and consultation, the Law Reform Commission finalised its report and proposed a draft Children's Bill in January 2003.

The Department of Social Development then took the process further through close liaison with the national Departments of Justice and Constitutional Development, Education, Health, Labour, the South African Police Service, the provinces, national non-governmental organisations and service providers as well as the Office on the Rights of the Child in the Presidency. After extensive discussions in the parliamentary committees and two rounds of public hearings, the Children's Act was finally passed by Parliament in December 2005 and the President assented to the Children's Act on 8 June 2006. The Children's Act will take effect on a date fixed by the President by proclamation in the Government Gazette.

### **OBJECTS**

The objects of the Children's Act are:

- (a) To promote the preservation and strengthening of families;
- (b) To give effect to certain constitutional rights of children;

- (c) To give effect to the Republic's obligations concerning the well-being of children in terms of international instruments binding on the Republic;
- (d) To make provision for structures, services and means for promoting and monitoring the sound physical, psychological, intellectual, emotional and social development of children;
- (e) To strengthen and develop community structures which can assist in providing care and protection for children;
- (f) To protect children from discrimination, exploitation and any other physical, emotional or moral harm or hazards;
- (g) To provide care and protection for children who are in need of care and protection;
- (h) To recognise the special needs that children with disabilities may have; and
- (i) Generally, to promote the protection, development and well-being of children.

The Amendment Bill further expands on the above-mentioned objects of the Children's Act by proposing to insert the sections that pertain to the provincial sphere of government. The parts to be inserted may be summarised as follows:

- Chapter 5 deals with partial care and the approval and registration of partial care facilities, while chapter 6 regulates early childhood development and the approval and registration of early childhood development programmes.
- Part 1 of chapter 7 makes further provision for the protection of children by providing for a strategy for child protection and the reporting of children that has been seriously abused, sexually abused or deliberately neglected. The designation of child protection organisations is also regulated in this part of the Amendment Bill. Part 4 of chapter 7 amongst others deals with child-headed households, the unlawful removal or detention of children and corporal punishment.
- Chapter 11 provides for alternative care of children and chapters 12 and 13 further expand on alternative care by respectively regulating foster care and child and youth care centres.
- Chapter 13 determines that child and youth care centres must comply with certain requirements, be registered, offer certain programmes to children in the care of these centres, must have a management system and that a quality assurance process must be carried out in respect of the centres.
- Chapter 14 regulates the establishment and registration of and norms and standards for shelters and drop-in centres.
- 

Other amendments proposed are amendments to bring the long title, regulations provided for and the offences section in line with the amendments to be effected by this Bill.

### **CONSULTATION**

Apart from the broad consultation process followed by the South African Law Reform Commission during its review of the Child Care Act, 1983, the Department of Social Development also distributed the original consolidated Bill to national departments, the provinces, non-governmental organisations and other service providers for comment. The consolidated Bill was also published for general comment in the Gazette on 13 August 2004. During the course of 2006, the Department of Social Development consulted other national departments, the provinces and non-governmental organisations through the holding of a series of workshops. It is also envisaged that public hearings on the Amendment Bill will be held once the Bill is in the parliamentary process.

### **FINANCIAL IMPLICATIONS FOR STATE**

The Children's Act and the proposed Amendment Bill has been through an extensive and detailed costing process. The process involved all national and provincial departments that play a part in the implementation of the Children's Act and the proposed Children's Amendment Bill. The final costing report was submitted to the Minister of Social Development in July 2006.



**PARLIAMENTARY PROCEDURE**

The Department of Social Development and the State Law Advisors are of the view that this Amendment Bill must be dealt with by Parliament in accordance with the procedure established by Section 76 of the Constitution.

11.10	<b>MUNICIPAL MANAGER</b>
-------	--------------------------

11.10.1	<b>MUNICIPAL PARTNERSHIP FOR HUMAN RIGHTS</b>
---------	---

**Collaborator No:**

**IDP KPA Ref No:**

**Meeting Date:**

**Good Governance and Compliance**

**17 November 2020**

**1. SUBJECT: MUNICIPAL PARTNERSHIP FOR HUMAN RIGHTS**

**2. PURPOSE**

To obtain Council's approval for entering into a partnership with a Swedish Municipality on the topic of Human Rights. The detail of this project will be discussed and negotiated during the inception phase. This partnership will be undertaken in accordance with the 2030 Agenda for Sustainable Development and its Global Goals.

**3. DELEGATED AUTHORITY**

Council.

**4. EXECUTIVE SUMMARY**

Stellenbosch Municipality (SM) has been approached by the Swedish International Centre for Local Democracy (ICLD) to explore the possibility of entering into a partnership with a Swedish Municipality selected by ICLD on the topic of Human Rights. The Human Rights topic that the Municipality wants to work on with SM will be finalised during the Inception Phase.

SM has over the years developed various programmes premised on enhancing and protecting the Human Rights of its citizens. These programmes allow explicitly for the inclusion of minorities, such as the disabled, the frail and infirm and provide this traditionally marginalised group full access to its attempts at local government. Governmentality refers to the relationship in this case between the local government and its local community. It also refers to inclusivity and an attempt by mostly the local government at moving away from top-down relations and the community having its voice heard on many issues. A good example of governmentality is the Integrated Development Plan's public participation processes. The recent iteration of the IDP saw new innovations being introduced to secure an inclusive process and therewith ensuring that local government meets the community.

In essence, SM has an exportable product which has attracted the attention of in this instance international institutions. It is therefore, incumbent upon us to strengthen our understanding of governmentality by sharing our learnt experiences and learning from an ages old democracy.

The programme consists of various phases and under normal circumstances runs over a four (4) year period. The first phase is the Inception Phase which runs for one (1) year. During this phase the exact collaboration project is finalised for implementation in the 3 outer years.

The project is funded by ICLD and will according to their programme commence in January 2021.

---

**5. RECOMMENDATIONS**

- (a) that Council notes the invitation by ICLD annexed hereto as “**APPENDIX 1**”;
- (b) that Council approves that Stellenbosch Municipality enters into a partnership with a Swedish Municipality on the topic of Human Rights;
- (c) that the Municipal Manager be authorized to negotiate the terms of the partnership agreement with the identified Swedish Municipality as per the requirements of the Inception Phase of the partnership; and
- (d) that the Municipal Manager submits a report to Council subsequent to the conclusion of the Inception Phase, i.e. after one (1) year or as soon as practically possible thereafter.

**6. DISCUSSION / CONTENTS****6.1 Background**

Stellenbosch Municipality has been approached by the Swedish International Centre for Local Democracy (ICLD) to explore the possibility of entering into a partnership with a Swedish Municipality selected by ICLD on the topic of Human Rights. One of the Human Rights topics that the Swedish municipalities want to work on with SM, is the notion of *disability rights and access*.

ICLD was directed to Stellenbosch Municipality by the Community Organisation Resource Centre (CORC). SM and CORC has a long standing relationship which started in the informal settlements of Langrug and Enkanini. This relationship was initially cemented through a Memorandum of Understanding (MOU) and in recent years CORC was appointed by the Provincial Department of Human Settlements (PDoHS) as the preferred NGO to work with SM. The work that CORC and SM did together concentrated on amongst others security of tenure, access to basic services and increased access to municipal services.

On the referral by CORC, ICLD initiated contact with SM in order to establish if there are indeed grounds to establish a partnership. Parallel to this process ICLD also commenced with looking for a Swedish partner for SM – the latter has now been established.

*“Since we have found Stellenbosch to be a highly suitable partner, we hope that you see the benefits of joining the programme. If so, we already have an interested Swedish partner municipality to present to you.”*

The project consists of several phases which commences with the project Initiation Phase which is the platform for finding common grounds where the ground work for the partnership will be done. According to ICLD, the next step would be to complete an application for an Inception Phase, to be carried out in 2021. The final detail of the partnership will be thrashed out through the Inception Phase of the partnership.

**6.2 Discussion**

Stellenbosch Municipality has entered into partnership agreements with European municipalities before, such as municipalities in Belgium. According to the participants in these partnerships, the learning experience has been immense and many of the lessons learnt by both parties are to this day being implemented by the respective municipalities.

It is commonly known that the Swedish local government system is one of the most advanced and matured systems and the lessons learnt can be immeasurable to SM. On the other hand, SM has developed a system of governmentality through amongst others its Integrated Human Settlements section which seriously supports the notion developmental government. To this extent there are hopefully many lessons that can be exchanged by SM and be imparted on a broader audience.

It is therefore imperative that SM enters into the partnership agreement and commence with the preparatory work of the Inception Phase.

### 6.3 Financial Implications

a) ICLD is funding the project.

*"... conduct a three-year project on a topic of their choice related to Human Rights, with funding from the ICLD"*

### 6.4 Legal Implications

The recommendations in this report comply with Council's policies and all applicable legislation.

### 6.5 Staff Implications

No staff implications to the Municipality.

### 6.6 Previous / Relevant Council Resolutions

None.

### 6.7 Risk Implications

None.

### 6.8 Comments from Senior Management

No comments are required from Senior Management.

## **RECOMMENDATIONS FROM THE EXECUTIVE MAYOR, IN CONSULTATION WITH THE EXECUTIVE MAYORAL COMMITTEE, TO COUNCIL: 2020-11-17: ITEM 7.10.1**

- (a) that Council notes the invitation by ICLD annexed hereto as "**APPENDIX 1**";
- (b) that Council approves that Stellenbosch Municipality enters into a partnership with a Swedish Municipality on the topic of Human Rights;
- (c) that the Municipal Manager be authorized to negotiate the terms of the partnership agreement with the identified Swedish Municipality as per the requirements of the Inception Phase of the partnership; and
- (d) that the Municipal Manager submits a report to Council subsequent to the conclusion of the Inception Phase, i.e. after one (1) year or as soon as practically possible thereafter.

## **ANNEXURES**

Appendix 1: Invitation

### **FOR FURTHER DETAILS, CONTACT:**

<b>NAME</b>	Geraldine Mettler
<b>POSITION</b>	Municipal Manager
<b>DIRECTORATE</b>	Municipal Manager
<b>CONTACT NUMBERS</b>	021 808 8025
<b>E-MAIL ADDRESS</b>	<a href="mailto:municipal.manager@ Stellenbosch.gov.za">municipal.manager@ Stellenbosch.gov.za</a>
<b>REPORT DATE</b>	9 November 2020

# APPENDIX 1

**From:** Rikard Eduards [<mailto:rikard.eduards@icld.se>]  
**Sent:** Wednesday, 04 November 2020 15:51  
**To:** Nomie Tshefu <[Nomie.Tshefu@stellenbosch.gov.za](mailto:Nomie.Tshefu@stellenbosch.gov.za)>  
**Cc:** Johru Robyn <[Johru.Robyn@stellenbosch.gov.za](mailto:Johru.Robyn@stellenbosch.gov.za)>; Myriam Chilvers <[myriam.chilvers@icld.se](mailto:myriam.chilvers@icld.se)>  
**Subject:** [EX] Municipal Partnership for Human Rights

Dear Nomie Tshefu,

My name is Rikard Eduards, I work for the Swedish International Center for Local Democracy ([www.icld.se](http://www.icld.se)). I received your contact details from a researcher in our network, Andrew Siddle, PhD in Business Administration, University of Cape Town.

Andrew suggested we contact you, as the Chief Administrative Officer in the office of the Municipal Manager, Geraldine Mettler, and present the below explained opportunity to apply for a “Municipal Partnerships for Human Rights” to her. Our concrete question is if Stellenbosch is interested in initiating such a partnership together with a Swedish municipality. In order to sync all activities involved we need a swift response preferably within one week – an urgency I apologize for! Naturally such a confirmation of interest would not involve formal obligations.

Municipal Partnerships for Human Rights involves a few selected municipalities in Sweden and the Southern Africa region that will be matched by ICLD and conduct a three year project on a topic of their choice related to Human Rights, with funding from the ICLD. The municipalities will receive support by ICLD and be able to network and exchange experiences with each other to reach both individual and joint goals.

Our partnerships are usually 3 years in length and involve two international study visits between municipalities a year. In between time the partnerships continue working on human rights projects of their choice. The partnerships start with a 1-year Inception Phase through which the partners get to know each other and investigate potential project cooperation areas.

This is our website if you want to find out more: <https://icld.se/en/municipal-partnership/>

This is a link to our Human Rights initiative: <https://icld.se/en/article/humanrights/>

My colleague Myriam Chilvers has recently been in touch with Johru Robyn in Stellenbosch, Manager Informal Settlements (both in Cc), and have had fruitful discussions on collaboration themes within Human Rights. However we need a confirmation that Stellenbosch as a municipality is interested in initiating a Municipal Partnership for Human Rights, which must then come from the appropriate level. This is why we kindly ask you to urgently discuss this with the municipal manager. I apologize again for the urgency, the reason being that we would like to launch this initiative in early 2021 when a network of local governments will be forged.

Since we have found Stellenbosch to be a highly suitable partner, we hope that you see the benefits of joining the programme. If so, we already have an interested Swedish partner municipality to present to you. The next step would be to fill in an application for an Inception Phase, to be carried out in 2021. We will assist you in the application process and our aim is that all applications be filed, assessed and approved this year. See overall timeline below.

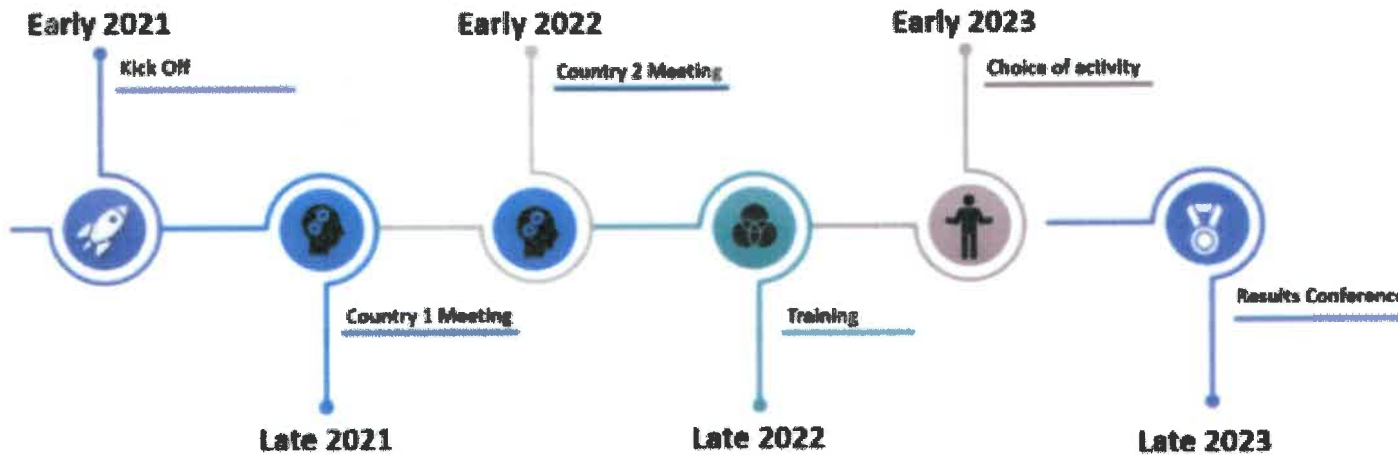

I hope I have supplied sufficient information about the initiative that we propose, please do not hesitate to contact me with any questions or comments that you may have.

Kind regards,

**Rikard Eduards**

Programme Officer Municipal Partnerships

+46 72 941 89 53

[rikard.eduards@icld.se](mailto:rikard.eduards@icld.se)

skype: rikarde.icld

[www.icld.se](http://www.icld.se)

[ICLD on Facebook](#)

[ICLD on Twitter](#)

<b>12.</b>	<b>CONSIDERATION OF ITEMS, REPORTS, COMMUNICATIONS, PETITIONS AND APPLICATIONS SUBMITTED VIA THE OFFICE OF THE MUNICIPAL MANAGER</b>
<b>12.1</b>	<b>MUNICIPAL PUBLIC ACCOUNTS COMMITTEE (MPAC): [CLLR WF PIETERSEN]</b>
<b>12.1.1</b>	<b>CONSIDERATION OF EXPENDITURE INCURRED RELATING TO SERVICES RENDERED BY KILOTREADS (PTY) LTD</b>

Collaborator No:

IDP KPA Ref No:

Good Governance

Meeting Date:

05 November 2020 &amp; 25 November 2020

**1. SUBJECT: CONSIDERATION OF EXPENDITURE INCURRED RELATING TO SERVICES RENDERED BY KILOTREADS (PTY) LTD**

**2. PURPOSE OF REPORT**

To provide information regarding the expenditure incurred for investigation by MPAC and to be recommended to and consideration by Council to ratify the expenditure in terms of the MFMA Section 32 (2). The expenditure with regard to the procurement of services for the supply, delivery, repair and fitment of tyres on various vehicles for Waste Management during the months of November and December 2019 is regarded as irregular because it breached the procurement process.

**3. DELEGATED AUTHORITY**

Council

**4. EXECUTIVE SUMMARY**

FQ 16/19 was awarded to Kilotreads (Pty) Ltd on 9 November 2018 for the supply, deliver, repair and fitment of tyres on vehicles for Waste Management Services. Various order numbers were generated on this FQ with the last order number being, Order Number: 357 798 (Annexure B) which was generated on 18 November 2019 for a total amount of R30 000 (incl. VAT) for all tyres on the FQ. The official in charge of fleet services was given the incorrect impression by the service provider that there were sufficient funds on the order. The services of Kilotreads (Pty) Ltd were immediately terminated once this information came to light and a new FQ process was initiated. The work performed was thus based on the expired FQ and the service rendered continued by default.

**5. RECOMMENDATION**

For MPAC consideration.

**6. DISCUSSION**

The Waste Management Department requires an external service provider to supply, deliver, repair and fit tyres on various vehicles utilised by this department. Waste collection and transport thereof remains a core functional activity for continued service delivery, and it is thus essential that the fleet is fitted with tyres and are legally compliant to render the service to the public.



---

The procurement of a service provider was done via an FQ process, and Kilotreads (Pty) Ltd was the successful service provider. The official in charge of fleet services for Waste Management, Mr A Heyns was given the incorrect impression by the service provider's representative, Mr P Venter that there were sufficient funds on the order (see attached emails – Annexure A). When it came to light that this was not the case, the services of Kilotreads (Pty) Ltd was stopped with immediate effect.

The intent was in good faith as it was not on purpose, and in the interest of continued service delivery.

While the process was admittedly flawed, it is agreed that there were no *male fide*, personal gain or loss for Council, and it is requested that consideration be given to certify the expenditure as irrecoverable and that it be written off.

As recommended in similar recent instances, the need is recognized for improvement and correct procedures in general, with the need for a training program for all level of managers undertaking financial transactions on behalf of Council to be trained or retrained. It is especially important for staff to be informed of correct procedures and the implications of latest financial circulars, changes to policy, etc. The administration has requested the drafting of the necessary SOP's in the corporate SOP project, which will also assist in removing the risk of a recurrence.

#### **7. FINANCIAL IMPLICATIONS**

Provision has been made from 20190703005940 in the 2019/20 budget for the amount of R9 407(VAT incl.) – Annexure C

#### **8. LEGAL IMPLICATIONS**

The recommendations in this report comply with Council's policies and all applicable legislation

Supply Chain Management Policy, 4.36.1a (i)

Supply Chain Management Policy, 4.36.b

Supply Chain Regulation 36(1)

MFMA Section 32(2)

#### **9. RISK IMPLICATIONS**

All intent was in good faith, the breach can be attributed to the initial planning processes and the lack of capacity with regard to ensuring required financial compliances are adhered to.

#### **10. CONCLUSION**

It is acknowledged that there were minor breaches of the procurement processes. If the process was followed correctly however, the outcome and cost would have been identical. Council incurred no loss during this process and there was no intentional disregard of Council's procurement processes. It is therefore requested that the expenditure be written off because the services were rendered. As part of consequence management, the necessary disciplinary actions will be followed against the defaulting individuals.

**11. COMMENTS FROM THE MUNICIPAL MANAGER**

Contract management remains the responsibility of the user department to ensure that sufficient funds are available. In an email dated 28/11/2019, the service provider indicated only R1997.00 is left on the order which was a clear indication that the order was not sufficient. Better checks and balances to be put in place by the department. The municipality did receive the service and there was value for money. Officials concerned should be counselled re non-compliance and a Standard Operating Procedure with clear checks and balances put in place to prevent recurrence.

**12. COMMENTS FROM SUPPLY CHAIN MANAGER**

Supply Chain Management take note and will again communicate the SCM governance and compliance framework to all user departments.

**MPAC MEETING: 2020-11-05: ITEM 5.1**

MPAC took note of the circumstances and facts as provided in the report, as well as the input from administration with reference to the assurance that matters are now in place to ensure uninterrupted service delivery especially over the holiday period.

**RECOMMENDATIONS FROM MPAC TO COUNCIL: 2020-11-05: ITEM 5.1**

- (a) that Council certifies the irregular expenditure to the amount of R 9407,00 (excluding VAT) as irrecoverable; and
- (b) that Council writes off the irregular expenditure as irrecoverable in terms of the MFMA Section 32(2).

**ANNEXURES**

- Annexure A – Email correspondence between official and service provider
- Annexure B – Order 357798 (FQ 16/19)
- Annexure C – Invoices

**FOR FURTHER DETAILS CONTACT:**

<b>NAME</b>	Deon Louw
<b>POSITION</b>	<b>Director: Infrastructure Services</b>
<b>DIRECTORATE</b>	<b>Infrastructure Services</b>
<b>CONTACT NUMBERS</b>	<b>021 808 8213</b>
<b>E-MAIL ADDRESS</b>	<b><u>Deon.louw@ Stellenbosch.gov.za</u></b>
<b>REPORT DATE</b>	<b>16 October 2020</b>

# **ANNEXURE A**

## Clayton Hendricks

---

**From:** Albertus Heyns  
**Sent:** Friday, December 20, 2019 11:11 AM  
**To:** Clayton Hendricks  
**Subject:** FW: [EX] BEDRAG OOR OP ORDER

Hier is een soek die ander.

**From:** Phillip Venter [mailto:managerstb@kilotreads.co.za]  
**Sent:** Thursday, 28 November 2019 12:04  
**To:** Albertus Heyns  
**Subject:** [EX] BEDRAG OOR OP ORDER

Appels

Nog net R1997.50 oor op die order

Sterkte

*Philip Venter*

*Kilotreads Stellenbosch*

*Self: +27 82 320 5970*

*Tel: +27 21 887 3115*

*Fax: +27 21 883 2704*

*Mail: [managerstb@kilotreads.co.za](mailto:managerstb@kilotreads.co.za)*





**From:** Magda [mailto:magda@kilotreads.co.za]

**Sent:** 09 December 2019 09:59 AM

**To:** Nomzi Mlenze

**Subject:** [EX] Remittance R8855.00

Hallo Nomzi,

Kan jy asb die remittance vir my aanstuur?

**Vriendelike groete/Kind regards**

**Maggie Pretorius**

**Debiteure - Kilotreads/Supa Quick Paarl**

**Tel: 021-860 2380**

**Faks: 021-8726876**

**Posbus 2564**

**Paarl, 7620**

# **ANNEXURE B**



# Stellenbosch

MUNISIPALITEIT • UMASIPALA • MUNICIPALITY

LOTREADS STELLENBOSCH  
2 BIRD STREET  
STELLENBOSCH  
WESTERN CAPE  
7599

KREDITEUR NR.  
CREDITORS NO. 001516

BESTEL NR. / ORDER NO.  
357798

DATUM / DATE  
06/11/2019

KONTAK PERSOON / CONTACT PERSON  
MIRENCIA WILLIAMS  
Requisition No. 1064903

POS NR. / VOTE NO	HOEVEELHEID / QUANTITY	PRYSE SONDER BTW / PRICES WITHOUT VAT	BTW/VAT	TOTALE PRYS / TOTAL PRICE
AN 1 WHEN NEEDED	16698.70 R	2504.50	19203.50	
<b>TOTAAL TOTAL</b>				19203.50

FOR: STELLENBOSCH

*R* 11.11.2019  
HANDTEKENING / SIGNATURE  
DEPARTEMENT / DEPARTMENT



Our business keeps you moving

## P.O.D. / WORKSHEET 111197

Cust. Company Name: MUN  PRL  STB  
 Date: 29/11/19  
 Cust. Company Telephone: \_\_\_\_\_ Fax: \_\_\_\_\_  
 Cust. Order No.: \_\_\_\_\_ Reg. / Fleet No.: CU22049  
 Cust. Contact: \_\_\_\_\_ Cell No.: 08292 118  
 Truck Km: \_\_\_\_\_ Time Arrived: \_\_\_\_\_ Time Completed: 15:40  
 Location: KRIP NUTS

Quantity	Description	Qty	Tyre Size	Serial No.	Signature
x	Call Out				
x	Demount & Fit				
x	Puncture Repair - Size		12.5/80-18		
x	Wheel Rotation		N/A 5 Gaiter fitted		
x	Fit New Tyre				
x	Fit Retread				
x	Fit Tube				
	Km Travelled				

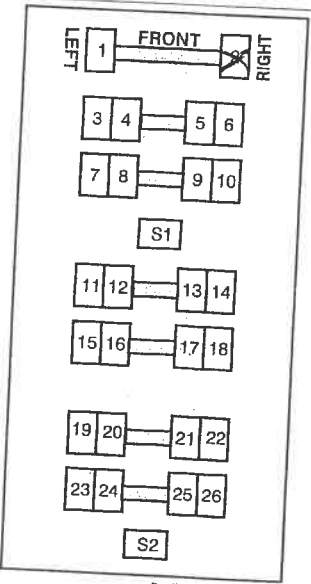

ALL MATERIALS USED REMAIN THE PROPERTY OF KILO TREADS UNTIL FULLY PAID FOR.

Job done by Service Driver - Name: Peter / Cape Signature: \_\_\_\_\_

All repairs and work carried out, checked and accepted.  
To be re-checked by Client / Driver after 100km as well.

Customer Driver Name: \_\_\_\_\_ Signature: \_\_\_\_\_



Invoice No.: SSA140176

# **ANNEXURE C**





**MEMO**  
 DEPARTMENT OF INFRASTRUCTURE SERVICES  
 DEPARTEMENT VAN INFRASTRUKTUURDIENSTE

**TO:** Chief Financial Officer  
 Kevin Carolus

**FROM:** Acting Snr Manager: Waste Management  
 Clayton Hendricks

**DATE:** 4 March 2020

**SUBJECT:** OVERDUE INVOICES (KILOTREADS)

The attached invoices, to the amount of R8855.00, authorised for payment by the former Senior Manager: Waste Manager (Saliem Haider) has reference.

The reason for the invoices not being paid, is that work was performed without an official order. You are hereby kindly requested to authorise payment for these invoices as the service provider is awaiting payment since November 2019

Clayton Hendricks

Acting Senior Manager: Waste Management

Date:

Deon Louw

Director: Infrastructure Services

Date:

A formal report to be submitted to MPAC for the transgression of Section 32, 76(1)(c) of the MFMA.

Consequence management actions to be taken.





Kilotreads Stellenbosch (Pty) Ltd  
182 Bird Street, Stellenbosch, , 7600

Tel: 021-8873115, Fax: 021-8832704  
Vat: 4060111210 , Reg No: 1981/002231/07

Invoice Date 15/11/2019

<b>To:</b>	<b>Deliver To:</b>
Vat no: 4700102181	Stellenbosch Munisipaliteit
Stellenbosch Munisipaliteit	Trading As:
Trading As:	The Magasyn Master
P.O. Box 17	Helshoogte
Stellenbosch	Stellenbosch
7599	7599

Account No	Invoice Date	Order Number	Representative	DEL/POD	Reg Number	Page
S.MUN001	15/11/2019	357798	542 S-H Motibi (FSR)	CL 27923		1 of 1

Item Code	Description	Quantity	UnitPrice	Disc %	VatAmnt	Line Total
P0005	Puncture Repair Tube - Truck Industrial	1.00	150.00		22.50	150.00

Hereby I certify that / Hiermee sertifiseer ek dat  
VOTE / POS NOMMER: \_\_\_\_\_

(a) Goods / Services identified on this invoice was received.  
Goedere / Dienste geïdentifiseer op hierdie faktuur is ontvang.

(b) As per attached order, all goods and services delivered are allocated to the specified budget vote. Goedere en dienste gelewer is toegewys op die gespesifiseerde begrotingsposse soos op versoekende bestelling.

(c) Adequate funds are available on the budget vote /  
Voldoende fondse beskikbaar op die begrotingsposse.  
Expenditure is used in accordance with Council's SCM policy /  
Uitgawes word gebruik in ooreenstemming met die Raad se SCM beleid.

*Handwritten signature*  
28/11/2019

*Handwritten signature*

STELLENBOSCH MUNICIPALITY  
28 NOV 2019  
EXPENSURE  
ACCOUNTS PAYABLE

POD 1126820  
JOB DONE IN KILO YARD  
FITTER BUSHY  
8/11/2019

Subtotal (Exclusive)	150.00
Discount	
Vat	22.50
<b>Total</b>	<b>172.50</b>

Banking Details:  
First National Bank, Branch: 200610, Acc: 53750710536

EFT PAYMENTS ARE MORE SECURE AND WOULD BE APPRECIATED  
ACCOUNT TERMS: STRICTLY 30 DAYS FROM DATE OF STATEMENT AND CASH SALES  
STRICTLY CASH. INTEREST AT A RATE OF 20% PER ANNUM WILL BE CHARGED ON  
OVERDUE ACCOUNTS.

GOODS REMAIN THE PROPERTY OF KILOTREADS UNTIL PAID IN FULL AND WE  
RESERVE THE RIGHT OF REPOSSESSION

Print Name

Signature

*Handwritten signature* 21/11/19 DONE



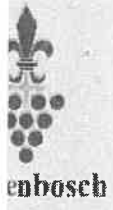

AMPTELIKE BESTELLING  
OFFICIAL ORDER

# Stellenbosch

MUNISIPALITEIT • UMASIPALA • MUNICIPALITY

BESTEL NR. / ORDER NO.  
357798

DATUM / DATE  
08/11/2019

STREADS STELLENBOSCH  
BIRD STREET  
LLENBOSCH  
TERN CAPE

KREDITEUR NR.  
CREDITORS NO. 001515

KONTAK PERSOON / CONTACT PERSON  
MIRENCIA WILLIAMS  
Requisition No. 1064903

LYN LINE	VOORRAAD NR. STOCK NO.	BESKRYWING / DESCRIPTION	POS NR. / VOTE NO.	HOEEVELHEID QUANTITY	PRYSE SONDER BTW PRICES WITHOUT VAT	BTW/VAT	TOTALE PRYS TOTAL PRICE
		STB P07SM16/19 SUPPLY AND FIT OF TYRES AS AND WHEN NEEDED	AN 1	164	R 98.70	19203.50	
					R 2504.80		

FOR: **STELLENBOSCH**  
HANDTEKENING SIGNATURE  
DEPARTEMENT DEPARTMENT

TOTAAL TOTAL  
19203.50



**P.O.D. / WORKSHEET** 112680  PPL  STB  
 Cust. Company Name: ALFA ROMEO Date: 8/11/19  
 Cust. Company Telephone: JOHNS WATSE Fax:  
 Cust. Order No.: 79 Reg. / Fleet No.: CF 27923  
 Cust. Contact: 79 Cell No.:  
 Truck Km: \_\_\_\_\_ Time Arrived: \_\_\_\_\_ Time Completed: \_\_\_\_\_  
 Location: \_\_\_\_\_

Quantity	Description	Taken from Stock			Signature
		Qty	Tyre Size	Serial No.	
X	Call Out				
X	Demount & Fit				
1	Puncture Repair - Size		315/80R22.5		
X	Wheel Rotation				
X	Fit New Tyre				
X	Fit Retread				
X	Fit Tube				
	Km Travelled				
	Tyre on : Size	Tyre on : Serial no.	Pos	Tyre off : Serial No.	

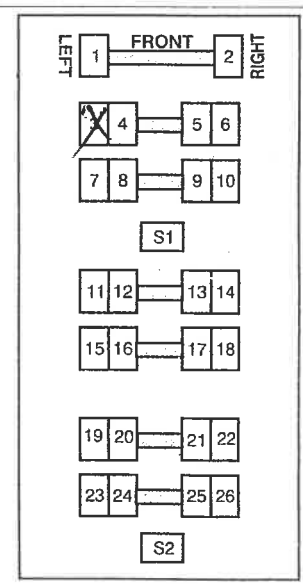

ALL MATERIALS USED REMAIN THE PROPERTY OF KILOTREADS UNTIL FULLY PAID FOR.

Job done by Service Driver - Name: MISHY Signature: \_\_\_\_\_

All repairs and work carried out - checked and accepted.  
To be re-checked by Client / Driver after 100km as well.

Customer Driver Name: S. Dampier Signature: \_\_\_\_\_ Invoice No.: \_\_\_\_\_



Borlinka - 872 1236



Kilotreads Stellenbosch (Pty) Ltd  
182 Bird Street, Stellenbosch, , 7600

Tel: 021-8873115, Fax: 021-8832704  
Vat: 4060111210 , Reg No: 1981/002231/07

Invoice Date 15/11/2019

To:  
Vat no: 4700102181  
Stellenbosch Munisipaliteit  
Trading As:  
P.O. Box 17  
Stellenbosch  
7599

Deliver To:  
Stellenbosch Munisipaliteit  
Trading As:  
The Magasyn Master  
Helshoogte  
Stellenbosch  
7599

Account No	Invoice Date	Order Number	Representative	DEL/POD	Reg Number	Page
S.MUN001	15/11/2019	357798	542 S-H Mothibi (FSR)	CL 22049		1 of 1

Item Code	Description	Quantity	UnitPrice	Disc %	VatAmnt	Line Total
C0001	Call Out - Normal Time	1.00	200.00		30.00	200.00
P0009	Puncture Repair Tube - Tractor Rear	1.00	250.00		37.50	250.00

Handwritten signature and date: *Maideh* 28/11/2019

Stamp: **STELLENBOSCH MUNICIPALITY**  
29 NOV 2019  
ACCOUNTS PAYABLE

Stamp: **AGRIKULTURIELE ERVEN**  
AGRIKULTURIELE ERVEN OFFISIELE  
AGRIKULTURIELE ERVEN OFFISIELE  
AGRIKULTURIELE ERVEN OFFISIELE

POD 111114  
FITTERS MANIE/RONNIE  
CL 22049  
L/R  
11/11/2019

Subtotal (Exclusive)	450.00
Discount	
Vat	67.50
<b>Total</b>	<b>517.50</b>

Banking Details:  
First National Bank, Branch: 200610, Acc: 53750710536

EFT PAYMENTS ARE MORE SECURE AND WOULD BE APPRECIATED  
ACCOUNT TERMS: STRICTLY 30 DAYS FROM DATE OF STATEMENT AND CASH SALES  
STRICTLY CASH. INTEREST AT A RATE OF 20% PER ANNUM WILL BE CHARGED ON  
OVERDUE ACCOUNTS.

GOODS REMAIN THE PROPERTY OF KILOTREADS UNTIL PAID IN FULL AND WE  
RESERVE THE RIGHT OF REPOSSESSION

Print Name

Signature

*Maideh* 21/11/19 DONE

We insure our debtors with



**CREDIT GUARANTEE**

ENABLING CREDIT WITHOUT RISK

MEMBER OF THE CREDIT GUARANTEE ASSOCIATION OF SOUTH AFRICA

MEMBER OF THE CREDIT GUARANTEE ASSOCIATION OF SOUTH AFRICA

MEMBER OF THE CREDIT GUARANTEE ASSOCIATION OF SOUTH AFRICA



# AMPTELIKE BESTELLING OFFICIAL ORDER

Page 795  
STELLENBOSCH 7599  
021 808-8520  
021 808-8688

## Stellenbosch

MUNISIPALITEIT • UMASIPALA • MUNICIPALITY

BESTEL NR. / ORDER NO.  
357798

DATUM / DATE  
06/11/2019

OTREADS STELLENBOSCH  
BIRD STREET  
LLENBOSCH  
TERN CAPE  
0

KREDITEUR NR.  
CREDITORS NO. 001516

KONTAK PERSOON / CONTACT PERSON  
MTRINETA WILLIAMS  
Requisition No. 1064903

RE LINE / ONLINE	VOORRAAD NR. / STOCK NO.	BESKRYWING / DESCRIPTION	POS NR. / VOTE NO.	HOEVEELHEID / QUANTITY	PRYSE SONDER BTW / PRICES WITHOUT VAT	BTW/VAT	TOTALE PRYS / TOTAL PRICE
		STB PD/06/15/19 SUPPLY AND FIT OF TYRES AS AND WHEN NEEDED	AN 1	166	98.70	19203.50	
				R	2504.80		

S / FOR: **STELLENBOSCH**  
Handwritten signature and date 11.11.2019  
HANTEKENSING SIGNATURE  
DEPARTEMENT DEPARTMENT

TOTAAL TOTAL  
19203.50



### P.O.D. / WORKSHEET 111114

Cust. Company Name: MUN. SOLID WASTE Date: 11/11/19  
Cust. Company Telephone: \_\_\_\_\_ Fax: \_\_\_\_\_  
Cust. Order No.: \_\_\_\_\_ Reg. / Fleet No.: CL 22049  
Cust. Contact: \_\_\_\_\_ Cell No.: \_\_\_\_\_  
Truck Km: \_\_\_\_\_ Time Arrived: \_\_\_\_\_ Time Completed: \_\_\_\_\_  
Location: BELTANA

Quantity	Description	Taken from Stock			Signature
		Qty	Tyre Size	Serial No.	
x	Call Out				
x	Demount & Fit	1	14x28	2ND TYRE	
x	Puncture Repair - Size	1			
x	Wheel Rotation				
x	Fit New Tyre				
x	Fit Retread				
x	Fit Tube				
	Km Travelled				
Tyre on : Size		Tyre on : Serial no.	Pos	Tyre off : Serial No.	

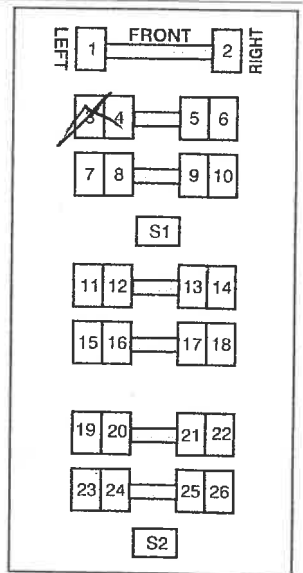

ALL MATERIALS USED REMAIN THE PROPERTY OF KILOTREADS UNTIL FULLY PAID FOR.

Job done by Service Driver - Name: MANIE ROUWIC Signature: \_\_\_\_\_

All repairs and work carried out - checked and accepted.  
To be re-checked by Client / Driver after 100km as well.

Customer Driver Name: LUYANDA MANA Signature: \_\_\_\_\_ Invoice No.: \_\_\_\_\_



Baillinka - 872 1236



Kilotreads Stellenbosch (Pty) Ltd  
182 Bird Street, Stellenbosch, , 7600

Tel: 021-8873115, Fax: 021-8832704  
Vat: 4060111210 , Reg No: 1981/002231/07

Invoice Date 15/11/2019

<p>To:</p> <p>Vat no: 4700102181</p> <p>Stellenbosch Munisipaliteit</p> <p>Trading As:</p> <p>P.O. Box 17</p> <p>Stellenbosch</p> <p>7599</p>	<p>Deliver To:</p> <p>Stellenbosch Munisipaliteit</p> <p>Trading As:</p> <p>The Magasyn Master</p> <p>Helshoogte</p> <p>Stellenbosch</p> <p>7599</p>
---	--

Account No	Invoice Date	Order Number	Representative	DEL/POD	Reg Number	Page
S.MUN001	15/11/2019	357798	542 S-H Mothibi (FSR)	CL 83465		1 of 1

Item Code	Description	Quantity	UnitPrice	Disc %	VatAmnt	Line Total
C0001	Call Out - Normal Time	1.00	200.00		30.00	200.00
P0009	Puncture Repair Tube - Tractor Rear	1.00	250.00		37.50	250.00

Hereby I certify that / Hiermee sertifiseer ek dat  
VOTE / POS NOMMER:

(a) Goods / Services identified on this invoice were received.  
Goedere / Diensle goeder/dienste is ontvang.

(b) As per attached order, all goods and services delivered are allocated to the specified  
budget vote. Goedere en dienste wat afgelewer is, is geaslooteer tot die spesifieerde  
begrotingsposisie en/of dienstelewerings.

(c) Adequate funds are available on the budget vote /  
Voldoende fondse is beskikbaar op die begrotingsposisie.  
Funding is provided in accordance with Category 8, 8C(1) policy /  
Ligging is verskaf in ooreenstemming met die Kategorie 8 en 8C(1) beleid.

*Maids*  
28/11/2019

*[Handwritten Signature]*

STELLENBOSCH MUNICIPALITY  
FINANCIAL SERVICES  
29 NOV 2019  
BANK OF BOTSWANA  
ACCOUNTS PAYABLE

POD 112723  
FITTERS PETROS/CASTRO  
FRANSCHOEK DIGGER  
12/11/2019

Subtotal (Exclusive)	450.00
Discount	
Vat	67.50
<b>Total</b>	<b>517.50</b>

Banking Details:  
First National Bank, Branch: 200610, Acc: 53750710536

EFT PAYMENTS ARE MORE SECURE AND WOULD BE APPRECIATED  
ACCOUNT TERMS: STRICTLY 30 DAYS FROM DATE OF STATEMENT AND CASH SALES  
STRICTLY CASH. INTEREST AT A RATE OF 20% PER ANNUM WILL BE CHARGED ON  
OVERDUE ACCOUNTS.

GOODS REMAIN THE PROPERTY OF KILOTREADS UNTIL PAID IN FULL AND WE  
RESERVE THE RIGHT OF REPOSSESSION



Print Name \_\_\_\_\_ Signature *[Handwritten Signature]* 21/11/19 Done



Stellenbosch

# AMPTELIKE BESTELLING OFFICIAL ORDER

Page 797  
17, STELLENBOSCH 7599  
021 808-8520  
021 808-8688

# Stellenbosch

MUNISIPALITEIT • UMASIPALA • MUNICIPALITY

BESTEL NR. / ORDER NO.

357798

DATUM / DATE

06/11/2019

OTREKERS STELLENBOSCH  
2 BIRD STREET  
STELLENBOSCH  
WESTERN CAPE  
7600

KREDITEUR NR.  
CREDITORS NO. 001516

KONTAK PERSOON / CONTACT PERSON

MIRENCIA WILLIAMS  
Requestion No. 1064903

SIE TONLINE	LYN	VOORRAAD NR. STOCK NO.	BESKRYWING / DESCRIPTION	POS NR. / VOTE NO.	HOEVEELHEID QUANTITY	PRYSE SONDER BTW PRICES WITHOUT VAT	BTW/VAT	TOTALE PRYS TOTAL PRICE
			STD FR/SML6/19 SUPPLY D FIT OF TYRES AS AND	AM 1 WHEN NEEDED R	16498	170	19203.50	
						2504.80		

AS / FOR: **STELLENBOSCH**  
HANDTEKENING SIGNATURE  
DEPARTEMENT DEPARTMENT

TOTAAL TOTAL  
19203.50



Our business keeps you moving

## P.O.D. / WORKSHEET

112723

PRL  STB

Cust. Company Name: Municipality Date: 12/11/19  
Cust. Company Telephone: \_\_\_\_\_ Fax: \_\_\_\_\_  
Cust. Order No.: \_\_\_\_\_ Reg. / Fleet No.: CC89465  
Cust. Contact: \_\_\_\_\_ Cell No.: 768  
Truck Km: \_\_\_\_\_ Time Arrived: \_\_\_\_\_ Time Completed: 07:30  
Location: Franschoek

Quantity	Description	Taken from Stock			Signature
		Qty	Tyre Size	Serial No.	
X	Call Out				
X	Demount & Fit				
X	Puncture Repair - Size				
X	Wheel Rotation				
X	Fit New Tyre				
X	Fit Retread				
X	Fit Tube				
	Km Travelled				
	Tyre on : Size	Tyre on : Serial no.	Pos	Tyre off : Serial No.	

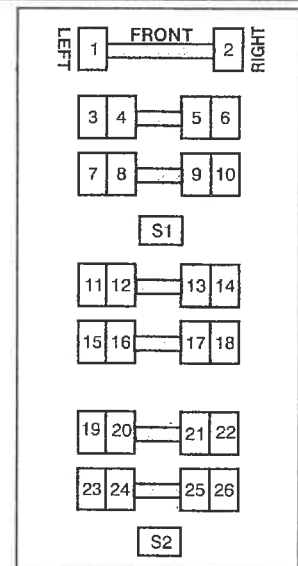

ALL MATERIALS USED REMAIN THE PROPERTY OF KILOTREADS UNTIL FULLY PAID FOR.

Job done by Service Driver - Name: Petero CAPHO Signature: \_\_\_\_\_

All repairs and work carried out -checked and accepted.  
To be re-checked by Client / Driver after 100km as well.

Customer Driver Name: \_\_\_\_\_ Signature: \_\_\_\_\_ Invoice No.: \_\_\_\_\_



N/C

Barlinka - 872 1236





Kilotreads Stellenbosch (Pty) Ltd  
182 Bird Street, Stellenbosch, , 7600

Tel: 021-8873115, Fax: 021-8832704  
Vat: 4060111210 , Reg No: 1981/002231/07

Invoice Date 18/11/2019

To:

Vat no: 4700102181  
Stellenbosch Munisipaliteit  
Trading As:  
P.O. Box 17  
Stellenbosch  
7599

Deliver To:  
Stellenbosch Munisipaliteit  
Trading As:  
The Magasyn Master  
Helshoogte  
Stellenbosch  
7599

Account No	Invoice Date	Order Number	Representative	DEL/POD	Reg Number	Page
S.MUN001	18/11/2019	357798	542 S-H Mthibi (FSR)	CL 83465		1 of 1

Item Code	Description	Quantity	UnitPrice	Disc %	VatAmnt	Line Total
C0001	Call Out - Normal Time	1.00	200.00		30.00	200.00
P0009	Puncture Repair Tube - Tractor Rear	1.00	250.00		37.50	250.00

Hereby I certify that / Hiermee sertifiseer ek dat  
VOTE / POS NOMMERS

(a) Goods / Services identified on this invoice was received.  
Goedere / Diensies geïdentifiseer op hierdie faktuur is ontvang.  
(b) As per attached order, all goods and services that are allocated to the specific budget vote, Goodere en diensies geïdentifiseer op die spesifieke begrotingsstemming word aan my- / ons gelever.  
(c) Accounts funds are available in the budget vote / Winkasrekening fondse beskikbaar op die begrotingsstemming.  
Expenditure / Uitgawe is in ooreenstemming met die begrotingsstemming / Uitgawe is in ooreenstemming met die begrotingsstemming.

*Maith*  
28/11/2019

POD 112778  
FITTERS PATRICK/MORGAN  
FRANSCHOEK DIGGER  
CL 83465  
OPERATOR PIETER  
R/R

STELLENBOSCH MUNICIPALITY  
FINANCIAL SERVICES  
29 NOV 2019  
EXPENSES  
ACCOUNTS PAYABLE

Subtotal (Exclusive)	450.00
Discount	
Vat	67.50
Total	517.50

Banking Details:  
First National Bank, Branch: 200610, Acc: 53750710536

EFT PAYMENTS ARE MORE SECURE AND WOULD BE APPRECIATED  
ACCOUNT TERMS: STRICTLY 30 DAYS FROM DATE OF STATEMENT AND CASH SALES  
STRICTLY CASH. INTEREST AT A RATE OF 20% PER ANNUM WILL BE CHARGED ON  
OVERDUE ACCOUNTS.

GOODS REMAIN THE PROPERTY OF KILOTREADS UNTIL PAID IN FULL AND WE  
RESERVE THE RIGHT OF REPOSSESSION

Print Name

Signature

*Maith* 21/11/19 DONE



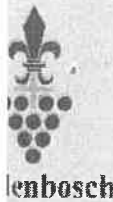

# AMPTELIKE BESTELLING OFFICIAL ORDER

Page 799

17, STELLENBOSCH 7599  
021 808-8520  
021 808-8686

# Stellenbosch

MUNISIPALITEIT • UMASIPALA • MUNICIPALITY

BESTEL NR. / ORDER NO.

357798

DATUM / DATE

06/11/2019

TYREADS STELLENBOSCH  
BIRD STREET  
LLENBOSCH  
TERN CAPE  
0

KREDITEUR NR.  
CREDITORS NO. 001516

KONTAK PERSOON / CONTACT PERSON

MIRENCIA WILLIAMS  
Registration No. 1064903

RE LINE / ONLINE	VOORRAAD NR. / STOCK NO.	BESKRYWING / DESCRIPTION	POS NR. / VOTE NO.	HOEVEELHEID / QUANTITY	PRYSE SONDER BTW / PRICES WITHOUT VAT	BTW/VAT	TOTALE PRYS / TOTAL PRICE
		STB FQ/SM16/19 SUPPLY AND FIT OF TYRES AS AND	AN 1	1	16698.70	19203.50	
			WHEN NEEDED	R	2504.80		

S/ FOR: **STELLENBOSCH**  
HANDTEKENING / SIGNATURE  
DEPARTEMENT / DEPARTMENT

TOTAAL TOTAL  
19203.50



## P.O.D. / WORKSHEET 112778 PRL STB

Cust. Company Name: Bellona Munisipaliteit 15/11/2019  
Cust. Company Telephone: 70 Fax: CL83465  
Cust. Order No.: 70 Reg. / Fleet No.: CL83465  
Cust. Contact: Jigger agterwiel Cell No.: 061/4181 Jigger  
Truck Km: Franschoek/Reservoir street Time Arrived: 9:45 Time Completed: 9:55  
Location: Franschoek/Reservoir street

Quantity	Description	Taken from Stock			Signature
		Qty	Tyre Size	Serial No.	
<input checked="" type="checkbox"/>	Call Out				
<input checked="" type="checkbox"/>	Demount & Fit		TYRE		
<input checked="" type="checkbox"/>	Puncture Repair - Size	1	16.9-28	Puncture Repair	
<input checked="" type="checkbox"/>	Wheel Rotation		GAITERS		
<input checked="" type="checkbox"/>	Fit New Tyre		BTS		
<input checked="" type="checkbox"/>	Fit Retread		BTS		
<input checked="" type="checkbox"/>	Fit Tube		BTS		
	Km Travelled				
	Tyre on : Size	Tyre on : Serial no.	Pos	Tyre off : Serial No.	

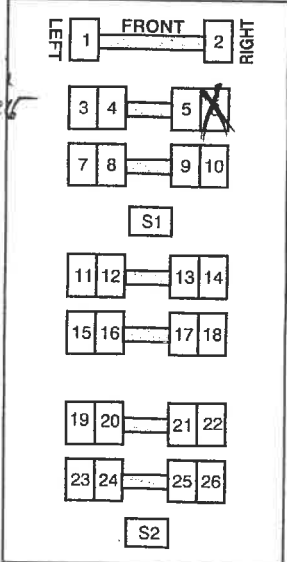

ALL MATERIALS USED REMAIN THE PROPERTY OF KILOTREADS UNTIL FULLY PAID FOR.

Job done by Service Driver - Name: Patrick Morgan Signature: [Signature]

All repairs and work carried out checked and accepted. To be re-checked by Client / Driver after 100km as well.

Customer Driver Name: Pieke Signature: [Signature] Invoice No.: \_\_\_\_\_



Borlinka - 872 1236



Kilotreads Stellenbosch (Pty) Ltd  
182 Bird Street, Stellenbosch, , 7600

Tel: 021-8873115, Fax: 021-8832704  
Vat: 4060111210 , Reg No: 1981/002231/07

Invoice Date 19/11/2019

To:  
Vat no: 4700102181  
Stellenbosch Munisipaliteit  
Trading As:  
P.O. Box 17  
Stellenbosch  
7599

Deliver To:  
Stellenbosch Munisipaliteit  
Trading As:  
The Magasyn Master  
Helshoogte  
Stellenbosch  
7599

Account No	Invoice Date	Order Number	Representative	DEL/POD	Reg Number	Page
S.MUN001	19/11/2019	357798	562 S-M Stander	CL 22049	CL 22049	1 of 1

Item Code	Description	Quantity	UnitPrice	Disc %	VatAmnt	Line Total
C0001	Call Out - Normal Time	1.00	200.00		30.00	200.00
P0009	Puncture Repair Tube - Tractor Rear	1.00	250.00		37.50	250.00

Hierby / Hierby / Hiermee sertifiseer ek dat  
VOIE / POS NOMMER:  
(a) Goods / Services provided on this invoice were received.  
Goedke / Dienste gelewer op hierdie / Hiermee sertifiseer ek dat  
(b) As per attached order, all goods and services received are allocated to the specific  
order no's. Geen goeder en dienste ontvangte toegewys op die gespesifiseerde  
bestelnommer / geen goeder en dienste ontvangte toegewys op die gespesifiseerde  
(c) Address / Adres is korrek en moet gebruik word /  
Vat no's / Vat nommer moet gebruik word op hierdie /  
Hiermee sertifiseer ek dat die goeder en dienste ontvangte  
Eenmalig / Hierby / Hiermee sertifiseer ek dat die goeder en dienste ontvangte  
Uitgewerkte / Hierby / Hiermee sertifiseer ek dat die goeder en dienste ontvangte

*J. J. J.*  
28/11/2019

STELLENBOSCH MUNISIPALITEIT  
FINANSIËLE DIENSTE  
29 NOV 2019  
REKENING  
ACCOUNTS PAYABLE

POD112750  
18/11/2019  
CL 22049  
TLB/DIGGER  
KLAPMUTS  
PETROS/CASTRO

Subtotal (Exclusive)	450.00
Discount	
Vat	67.50
Total	517.50

Banking Details:  
First National Bank, Branch: 200610, Acc: 53750710536

EFT PAYMENTS ARE MORE SECURE AND WOULD BE APPRECIATED  
ACCOUNT TERMS: STRICTLY 30 DAYS FROM DATE OF STATEMENT AND CASH SALES  
STRICTLY CASH. INTEREST AT A RATE OF 20% PER ANNUM WILL BE CHARGED ON  
OVERDUE ACCOUNTS.

GOODS REMAIN THE PROPERTY OF KILOTREADS UNTIL PAID IN FULL AND WE  
RESERVE THE RIGHT OF REPOSSESSION

Print Name

Signature

*[Signature]* 21/11/19 DOXIE





Stellenbosch

# AMPTELIKE BESTELLING OFFICIAL ORDER

Page 801  
STELLENBOSCH 7599  
021 808-8520  
021 808-8688

# Stellenbosch

MUNISIPALITEIT • UMASIPALA • MUNICIPALITY

BESTEL NR. / ORDER NO.  
357798

DATUM / DATE  
06/11/2019

OTRCADE STELLENBOSCH  
WIND STREET  
LLENBOSCH  
TERN CAPE  
0

KREDITEUR NR.  
CREDITORS NO. 601516

KONTAK PERSOON / CONTACT PERSON  
MIRENCIA WILLIAMS  
Requisition No. 1064903

RE LINE	VOORRAAD NR. STOCK NO.	BESKRYWING / DESCRIPTION	POS NR. / VOTE NO.	HOEVEELHEID QUANTITY	PRYSE SONDER BTW PRICES WITHOUT VAT	BTW/VAT	TOTALE PRYS TOTAL PRICE
		STB ER/SML6/19 SUPPLY D FIT OF TYRES AS AND	AN 1 WHEN NEEDED	1	16698.70 R	19203.50 2501.00	

S / FOR:  
STELLENBOSCH

Handwritten signature and date: 11.11.2019

TOTAAL TOTAL  
19203.50



Our business keeps you moving

## P.O.D. / WORKSHEET

112750

PRL  STB

Cust. Company Name: MUN Date: 18/11/19

Cust. Company Telephone: \_\_\_\_\_ Fax: \_\_\_\_\_

Cust. Order No.: \_\_\_\_\_ Reg. / Fleet No.: U22049

Cust. Contact: \_\_\_\_\_ Cell No.: 708

Truck Km: \_\_\_\_\_ Time Arrived: \_\_\_\_\_ Time Completed: 18:20

Location: KHAY NIITS

Quantity	Description	Taken from Stock			Signature
		Qty	Tyre Size	Serial No.	
X	Call Out				
X	Demount & Fit		TYRE		
X	Puncture Repair - Size		TUBE		
X	Wheel Rotation		GAITERS		
X	Fit New Tyre		BTS		
X	Fit Retread		BTS		
X	Fit Tube		BTS		
	Km Travelled				
	Tyre on : Size	Tyre on : Serial no.	Pos	Tyre off : Serial No.	

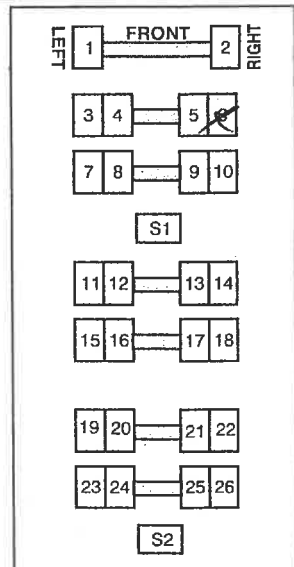

ALL MATERIALS USED REMAIN THE PROPERTY OF KILO TREADS UNTIL FULLY PAID FOR

Job done by Service Driver - Name: [Signature] Signature: [Signature]

All repairs and work carried out - checked and accepted.  
To be re-checked by Client / Driver after 100km as well.

Customer Driver Name: \_\_\_\_\_ Signature: \_\_\_\_\_ Invoice No.: \_\_\_\_\_



Barlinka - 872 1236



Kilotreads Stellenbosch (Pty) Ltd  
182 Bird Street, Stellenbosch, , 7600

Tel: 021-8873115, Fax: 021-8832704  
Vat: 4060111210 , Reg No: 1981/002231/07

Invoice Date 20/11/2019

To: Vat no: 4700102181 Stellenbosch Munisipaliteit Trading As: P.O. Box 17 Stellenbosch 7599	Deliver To: Stellenbosch Munisipaliteit Trading As: The Magasyn Master Helshoogte Stellenbosch 7599
--	---

Account No	Invoice Date	Order Number	Representative	DEL/POD	Reg Number	Page
S.MUN001	20/11/2019	357798	562 S-M Stander	CL83465	CL 83465	1 of 1

Item Code	Description	Quantity	UnitPrice	Disc %	VatAmnt	Line Total
C0001	Call Out - Normal Time	1.00	200.00		30.00	200.00
P0007	Puncture Repair Tube - Tractor Front	1.00	250.00		37.50	250.00

Handwritten signature and date stamp: 28/11/2019

Handwritten text: DONE 21/11/19

STELLENBOSCH MUNICIPALITY  
29 NOV 2019  
EXPENSES  
ACCOUNTS PAYABLE

POD112789  
19/11/2019  
ELB/MST DIGGER  
CL 834695  
FRANSCHOEK  
PATRICK/MORGAN

Subtotal (Exclusive)	450.00
Discount	
Vat	67.50
<b>Total</b>	<b>517.50</b>

Banking Details:  
First National Bank, Branch: 200610, Acc: 53750710536

EFT PAYMENTS ARE MORE SECURE AND WOULD BE APPRECIATED  
ACCOUNT TERMS: STRICTLY 30 DAYS FROM DATE OF STATEMENT AND CASH SALES  
STRICTLY CASH. INTEREST AT A RATE OF 20% PER ANNUM WILL BE CHARGED ON  
OVERDUE ACCOUNTS.

GOODS REMAIN THE PROPERTY OF KILOTREADS UNTIL PAID IN FULL AND WE  
RESERVE THE RIGHT OF REPOSSESSION

Print Name \_\_\_\_\_ Signature \_\_\_\_\_



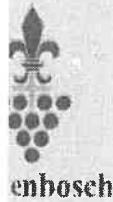

# AMPTELIKE BESTELLING OFFICIAL ORDER

Page 803  
17, STELLENBOSCH 7599  
021 808-8520  
021 808-8688

## Stellenbosch

MUNISIPALITEIT • UMASIPALA • MUNICIPALITY

BESTEL NR. / ORDER NO.  
357798

DATUM / DATE  
06/11/2019

OTREADS STELLENBOSCH  
WIND STREET  
LLENBOSCH  
TERN CAPE

KREDITEUR NR.  
CREDITORS NO. 001514

KONTAK PERSOON / CONTACT PERSON  
MIRENCIA WILLIAMS  
Requisition No. 1064903

RELYN ONLINE	VOORRAAD NR. STOCK NO.	BESKRYWING / DESCRIPTION	POS NR / VOTE NO.	HOEEVEELHEID QUANTITY	PRYSE SONDER BTW PRICES WITHOUT VAT	BTW/VAT	TOTALE PRYS TOTAL PRICE
		STE FR/SML6/19 SUPPLY D FIT OF TYRES AS AND	AN 1	1	16698.70	19203.50	
			WHEN NEEDED	R	2504.00		

S / FOR: **STELLENBOSCH**  
HANDTEKENING SIGNATURE  
DEPARTEMENT DEPARTMENT

TOTAAL TOTAL  
19203.50

deprinters.co.za



### P.O.D. / WORKSHEET 112789 PRL STB

Cust. Company Name: Beltana/Municipaliteit 19/11/2019  
Cust. Company Telephone: \_\_\_\_\_ Fax: \_\_\_\_\_  
Cust. Order No.: \_\_\_\_\_ Reg. / Fleet No.: EL83465  
Cust. Contact: Digger Voorwiel Cell No: ELB/MST Digger  
Truck Km: \_\_\_\_\_ Time Arrived: 8:15 Time Completed: 8:27  
Location: Frauschoek/Reservoir Street

Quantity	Description	Taken from Stock			Signature
		Qty	Tyre Size	Serial No.	
x	Call Out				
x	Demount & Fit		TYRE		
x	Puncture Repair - Size	1	TUBE	12.5/80-18	<u>puncture repair</u>
x	Wheel Rotation		GAITERS		
x	Fit New Tyre		BTS		
x	Fit Retread		BTS		
x	Fit Tube		BTS		
	Km Travelled				
	Tyre on : Size	Tyre on : Serial no.	Pos	Tyre off : Serial No.	

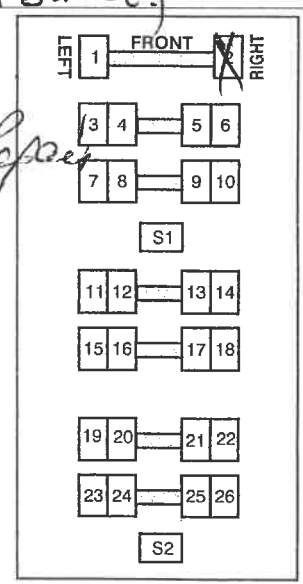

ALL MATERIALS USED REMAIN THE PROPERTY OF KILOTREADS UNTIL FULLY PAID FOR.

Job done by Service Driver - Name: Patrick Morgan Signature: [Signature]

All repairs and work carried out checked and accepted.  
To be re-checked by Client/Driver after 100km as well.

Customer Driver Name: [Signature] Signature: [Signature] Invoice No.: \_\_\_\_\_



Borlinka - 872 1236

Tax Invoice

SIN185816  
From:SSA140764.1



Kilotreads Stellenbosch (Pty) Ltd  
182 Bird Street, Stellenbosch, , 7600

Tel: 021-8873115, Fax: 021-8832704  
Vat: 4060111210 , Reg No: 1981/002231/07

Invoice Date 25/11/2019

To:

Vat no: 4700102181  
Stellenbosch Munisipaliteit  
Trading As:  
P.O. Box 17  
Stellenbosch  
7599

Deliver To:  
Stellenbosch Munisipaliteit  
Trading As:  
The Magasyn Master  
Helshoogte  
Stellenbosch  
7599

Account No	Invoice Date	Order Number	Representative	DEL/POD	Reg Number	Page
S.MUN001	25/11/2019	357798	562 S-M Stander	CL 83485	CL 83485	1 of 1

Item Code	Description	Quantity	UnitPrice	Disc %	VatAmnt	Line Total
C0001	Call Out - Normal Time	1.00	200.00		30.00	200.00
P0007	Puncture Repair Tube - Tractor Front	1.00	250.00		37.50	250.00

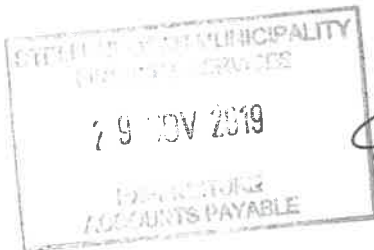

*[Handwritten signature]*

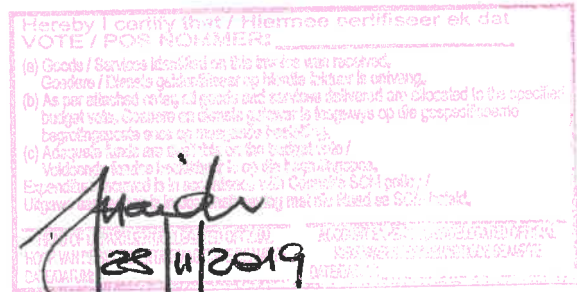

POD111166  
22/11/2019  
TLB  
CL 83485  
FRANSHOEK  
PETROS/CASTRO

Subtotal (Exclusive)	450.00
Discount	
Vat	67.50
Total	517.50

Banking Details:  
First National Bank, Branch: 200610, Acc: 53750710536

EFT PAYMENTS ARE MORE SECURE AND WOULD BE APPRECIATED  
ACCOUNT TERMS: STRICTLY 30 DAYS FROM DATE OF STATEMENT AND CASH SALES  
STRICTLY CASH. INTEREST AT A RATE OF 20% PER ANNUM WILL BE CHARGED ON  
OVERDUE ACCOUNTS.

GOODS REMAIN THE PROPERTY OF KILOTREADS UNTIL PAID IN FULL AND WE  
RESERVE THE RIGHT OF REPOSSESSION



Print Name

Signature

*[Handwritten signature]* 29/11/19 DONE.



AMPTELIKE BESTELLING  
OFFICIAL ORDER

17, STELLENBOSCH 7599  
021 808-8520  
021 808-8688

# Stellenbosch

MUNISIPALITEIT • UMASIPALA • MUNICIPALITY

BESTEL NR. / ORDER NO.  
357798

ORLANDS STELLENBOSCH  
BIRD STREET  
LLENBOSCH  
TERN CAPE  
0

KREDITEUR NR.  
CREDITORS NO. 001514

DATUM / DATE  
06/11/2019

KONTAK PERSOON / CONTACT PERSON  
MIRENSIA WILLIAMS  
Registration No. 1004903

LYN LINE	VOORRAAD NR. STOCK NO.	BESKRYWING / DESCRIPTION	POS NR / VOTE NO.	HOEVEELHEID QUANTITY	PRYSE SONDER BTW PRICES WITHOUT VAT	BTW/VAT	TOTALE PRYS TOTAL PRICE
		STB FORMERLY TY SUPPLY AND D FIT OF TYRES AS AND WHEN NEEDED	1	1.63	98.70	19203.50	50
				R	2507.80		

FOR: **STELLENBOSCH**  
HANDTEKENING  
SIGNATURE  
DEPARTEMENT  
DEPARTMENT

TOTAAL  
TOTAL  
19203.50



Our business keeps you moving

## P.O.D. / WORKSHEET 111186

PRL  STB

Cust. Company Name: Municipality Date: 22/11/19  
Cust. Company Telephone: \_\_\_\_\_ Fax: \_\_\_\_\_  
Cust. Order No.: \_\_\_\_\_ Reg. / Fleet No.: 203405  
Cust. Contact: \_\_\_\_\_ Cell No.: 708  
Truck Km: \_\_\_\_\_ Time Arrived: \_\_\_\_\_ Time Completed: 10:00  
Location: Park Road

Quantity	Description	Taken from Stock			Signature
		Qty	Tyre Size	Serial No.	
<input checked="" type="checkbox"/>	Call Out				
<input checked="" type="checkbox"/>	Demount & Fit				
<input checked="" type="checkbox"/>	Puncture Repair - Size		<u>12.5/107A</u>		
<input checked="" type="checkbox"/>	Wheel Rotation				
<input checked="" type="checkbox"/>	Fit New Tyre				
<input checked="" type="checkbox"/>	Fit Retread				
<input checked="" type="checkbox"/>	Fit Tube				
	Km Travelled				
	Tyre on : Size	Tyre on : Serial no.	Pos	Tyre off : Serial No.	

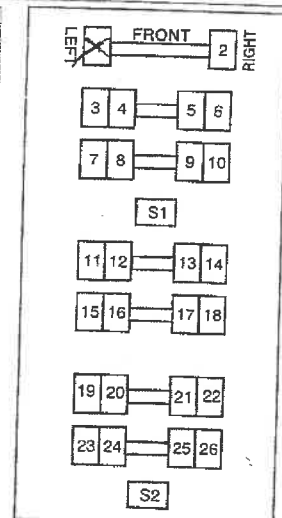

Barlinka - 872 1236

ALL MATERIALS USED REMAIN THE PROPERTY OF KILO TREADS UNTIL FULLY PAID FOR.

Job done by Service Driver - Name: Peter/Chris Signature: \_\_\_\_\_

All repairs and work carried out - checked and accepted.  
To be re-checked by Client / Driver after 100km as well.

Customer Driver Name: Peter Signature: \_\_\_\_\_



Invoice No.: \_\_\_\_\_



Tax Invoice

SIN185888  
From:SSA140800.1



Kilotreads Stellenbosch (Pty) Ltd  
182 Bird Street, Stellenbosch, , 7600

Tel: 021-8873115, Fax: 021-8832704  
Vat: 4060111210 , Reg No: 1981/002231/07

Invoice Date 26/11/2019

To:

Vat no: 4700102181  
Stellenbosch Munisipaliteit  
Trading As:  
P.O. Box 17  
Stellenbosch  
7599

Deliver To:  
Stellenbosch Munisipaliteit  
Trading As:  
The Magasyn Master  
Helshoogte  
Stellenbosch  
7599

Account No	Invoice Date	Order Number	Representative	DEL/POD	Reg Number	Page
S.MUN001	26/11/2019	357798	542 S-H Mothibi (FSR)	ELB/MST DIGGER	CL 22049	1 of 1

Item Code	Description	Quantity	UnitPrice	Disc %	VatAmnt	Line Total
C0001	Call Out - Normal Time	1.00	200.00		30.00	200.00
P0007	Puncture Repair Tube - Tractor Front	1.00	250.00		37.50	250.00



*[Handwritten signature]*

Hereby I certify that / Hiermee sertifiseer ek dat  
VOTE / POS NOKIEMER:

(a) Goods / Services listed on this invoice were received.  
Goedere / Diensle geleverde op hierdie faktuur is ontvang.  
(b) An per attached order, all goods and services referred are allocated to the specified budget vote. Goedere en dienste verwys na voorgesagde op die gespesifiseerde begrotingsposse was ontvang en geleverde.  
(c) Any goods listed are not held on the budget vote /  
Voldienste / diensle is nie gehou op die begrotingsposse.  
Expenditure / Uitgawe is nie toegestaan op die begrotingsposse.  
Uitgawe is nie toegestaan op die begrotingsposse.

*[Handwritten signature]*  
28/11/2019

POD 111258  
25/11/2019  
CL 22049  
ELB/MST DIGGER  
LOC:KLAPMUTS OORLAAI STASIE  
POS:RF  
OPERATOR:LUYANDA MANA  
FITTERS: PATRICK & MORGAN

Subtotal (Exclusive)	450.00
Discount	
Vat	67.50
Total	517.50

Banking Details:  
First National Bank, Branch: 200610, Acc: 53750710536

EFT PAYMENTS ARE MORE SECURE AND WOULD BE APPRECIATED  
ACCOUNT TERMS: STRICTLY 30 DAYS FROM DATE OF STATEMENT AND CASH SALES  
STRICTLY CASH. INTEREST AT A RATE OF 20% PER ANNUM WILL BE CHARGED ON  
OVERDUE ACCOUNTS.

GOODS REMAIN THE PROPERTY OF KILOTREADS UNTIL PAID IN FULL AND WE  
RESERVE THE RIGHT OF REPOSSESSION



Print Name \_\_\_\_\_ Signature *[Handwritten signature]*

27/11/19  
DONE



AMPTELIKE BESTELLING  
OFFICIAL ORDER

17. STELLENBOSCH 7599  
021 808-8520  
021 808-8686

# Stellenbosch

MUNISIPALITEIT • UMASIPALA • MUNICIPALITY

BESTEL NR. / ORDER NO.  
157798

DATUM / DATE  
06/11/2019

DIREKTORE STELLENBOSCH  
7 BIRD STREET  
STELLENBOSCH  
7600  
TEL: 021 808 8520

KREDITEUR NR.  
CREDITORS NO. 001514

KONTAK PERSOON / CONTACT PERSON  
MIRENCIA WILLIAMS  
Requisition No. 1064903

LEWY LINE	VOORRAAD NR. STOCK NO.	BESKRYWING / DESCRIPTION	POS NR / VOTENO.	HOEVEEHEID QUANTITY	PRYSSE SONDER B/W PRICES WITHOUT VAT	BTW/VAT	TOTALE PRYSSE TOTAL PRICE
		STS FR/CH16/19 SUPPLY D FIT OF TYRES AS AND	11	166	10.70	1920.50	50
		WHEN NEEDED	R		250.00		

11-11-2019  
HANDTEKENING  
SIGNATURE  
DEPARTMENT  
DEPARTMENT

TOTAAL  
TOTAL  
1920.50



## P.O.D. / WORKSHEET 111258

PRL  STB

Cust. Company Name: Munisipaliteit/Beltana Date: 25/11/2019

Cust. Company Telephone: By central stasie Fax:

Cust. Order No.: Reg. / Fleet No.: Cb 22049

Cust. Contact: Digger Voorwiel Cell No.: ECB/MST Digger

Truck Km: Time Arrived: 9:29 Time Completed: 10:03

Location: Klapmutspad

Quantity	Description	Taken from Stock			Signature
		Qty	Tyre Size	Serial No.	
<input checked="" type="checkbox"/>	Call Out				
<input checked="" type="checkbox"/>	Demount & Fit		TYRE		
<input checked="" type="checkbox"/>	Puncture Repair - Size		TUBE		
<input checked="" type="checkbox"/>	Wheel Rotation		GAITERS		
<input checked="" type="checkbox"/>	Fit New Tyre		BTS		
<input checked="" type="checkbox"/>	Fit Retread		BTS		
<input checked="" type="checkbox"/>	Fit Tube		BTS		
	Km Travelled				
	Tyre on : Size		Tyre on : Serial no.	Pos	Tyre off : Serial No.

1 12.5/18 - 18 structure repair  
(fit in No 3 and No 5 gaiters inside)

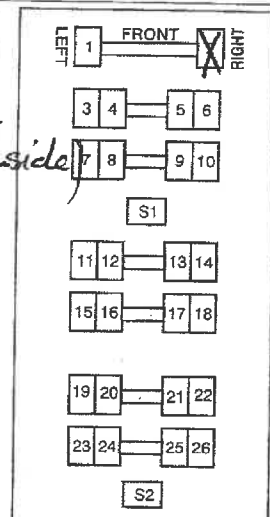

ALL MATERIALS USED REMAIN THE PROPERTY OF KILOTREADS UNTIL FULLY PAID FOR.

Job done by Service Driver - Name: Patrick Morgan Signature: [Signature]

All repairs and work carried out - checked and accepted.  
To be re-checked by Client / Driver after 100km as well.

Customer Driver Name: Luyanda Mawit Signature: [Signature]



Invoice No.: SSA140800

Borlino - 872 1236



Kilotreads Stellenbosch (Pty) Ltd  
182 Bird Street, Stellenbosch, , 7600

Tel: 021-8873115, Fax: 021-8832704  
Vat: 4060111210 , Reg No: 1981/002231/07

Invoice Date 15/11/2019

<p>To:</p> <p>Vat no: 4700102181</p> <p>Stellenbosch Munisipaliteit</p> <p>Trading As:</p> <p>P.O. Box 17</p> <p>Stellenbosch</p> <p>7599</p>	<p>Deliver To:</p> <p>Stellenbosch Munisipaliteit</p> <p>Trading As:</p> <p>The Magasyn Master</p> <p>Helshoogte</p> <p>Stellenbosch</p> <p>7599</p>
---	--

Account No	Invoice Date	Order Number	Representative	DEL/POD	Reg Number	Page
S.MUN001	15/11/2019	357798	542 S-H Mothibi (FSR)	CL 83463		1 of 1

Item Code	Description	Quantity	UnitPrice	Disc %	VatAmnt	Line Total
C0001	Call Out - Normal Time	1.00	200.00		30.00	200.00
P0009	Puncture Repair Tube - Tractor Rear	1.00	250.00		37.50	250.00

I hereby certify that / Hiermee sertifiseer ek dat  
VOTE / POS KOMMER:

(a) Goods / Services listed on this invoice to be received.  
Goedere / Dienste gelyk aan hierdie rekening is ontvang.

(b) As per attached order, all goods and services delivered are allocated to the specified budget code. Goedere en dienste gelyk aan hierdie rekening is toegesien op die spesifieke begrotingskode op die ooreenstemmende rekening.

(c) Amounts listed on this invoice to be paid.  
Veldwaaier bedrag wat betaal moet word op hierdie rekening.

Expansie / bedrag wat betaal moet word op hierdie rekening.  
Uitgawe / bedrag wat betaal moet word op hierdie rekening.

*Maids*  
28/11/2019

*[Handwritten signature]*

STELLENBOSCH MUNICIPALITY  
29 NOV 2019  
ACCOUNTS PAYABLE

POD 11105  
FRANCSHOEK DIGGER  
CL83463  
FITTERS MANIE/RONNIE  
8/11/2019  
R/R

Subtotal (Exclusive)	450.00
Discount	
Vat	67.50
Total	517.50

Banking Details:  
First National Bank, Branch: 200610, Acc: 53750710536

EFT PAYMENTS ARE MORE SECURE AND WOULD BE APPRECIATED  
ACCOUNT TERMS: STRICTLY 30 DAYS FROM DATE OF STATEMENT AND CASH SALES  
STRICTLY CASH. INTEREST AT A RATE OF 20% PER ANNUM WILL BE CHARGED ON  
OVERDUE ACCOUNTS.

GOODS REMAIN THE PROPERTY OF KILOTREADS UNTIL PAID IN FULL AND WE  
RESERVE THE RIGHT OF REPOSSESSION

Print Name \_\_\_\_\_ Signature *[Handwritten Signature]* 21/11/19 DONE



AMPTELIKE BESTELLING  
OFFICIAL ORDER

Page 809  
17, STELLENBOSCH 7599  
021 808-8520  
021 808-8688

# Stellenbosch

MUNISIPALITEIT • UMASIPALA • MUNICIPALITY

BESTEL NR. / ORDER NO.  
357798

DATUM / DATE  
06/11/2019

TREADS STELLENBOSCH  
STREET  
STELLENBOSCH  
SOUTH AFRICA

KREDITEUR NR.  
CREDITORS NO. 001516

KONTAK PERSOON / CONTACT PERSON  
MIRENCIA WILLIAMS  
Requisition No. 1064903

LYN / LINE	VOORRAAD NR. / STOCK NO.	BESKRYWING / DESCRIPTION	PGS NR. / VOTE NO.	HOEVEELHEID / QUANTITY	PRYSE SONDER BTW / PRICES WITHOUT VAT	BTW/VAT	TOTAAL PRYS / TOTAL PRICE
		STB FD/GMI6/19 SUPPLY D FIT OF TYRES AS AND	AN 1 WHEN NEEDED	1	14498.70 R 2504.80	19203.50	

FOR: **STELLENBOSCH**  
HANDTEKENING SIGNATURE  
DEPARTEMENT DEPARTMENT

TOTAAL TOTAL  
19203.50



P.O.D. / WORKSHEET 111105  PRL  STB  
Cust. Company Name: MUN. AREA CLEANING Date: 08/11/19  
Cust. Company Telephone: \_\_\_\_\_ Fax: \_\_\_\_\_  
Cust. Order No.: \_\_\_\_\_ Reg. / Fleet No.: CL83468  
Cust. Contact: \_\_\_\_\_ Cell No.: \_\_\_\_\_  
Truck Km: \_\_\_\_\_ Time Arrived: \_\_\_\_\_ Time Completed: \_\_\_\_\_  
Location: FRANSCATROCK

Quantity	Description	Taken from Stock			Signature
		Qty	Tyre Size	Serial No.	
x	Call Out				
x	Demount & Fit		TYRE		
x	Puncture Repair - Size	1	14x28		
x	Wheel Rotation		GAITERS		
x	Fit New Tyre		BTS		
x	Fit Retread		BTS		
x	Fit Tube		BTS		
	Km Travelled	425133426285			
	Tyre on : Size	Tyre on : Serial no.	Pos	Tyre off : Serial No.	

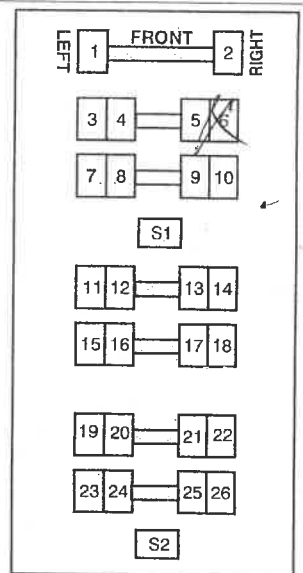

ALL MATERIALS USED REMAIN THE PROPERTY OF KILOTREADS UNTIL FULLY PAID FOR.

Job done by Service Driver - Name: Mami Rorve Signature: \_\_\_\_\_

All repairs and work carried out - checked and accepted.  
To be re-checked by Client / Driver after 100km as well.

Customer Driver Name: Ande Signature: \_\_\_\_\_ Invoice No.: \_\_\_\_\_



Barlinka - 872 1236



Kilotreads Stellenbosch (Pty) Ltd  
182 Bird Street, Stellenbosch, , 7600

Tel: 021-8873115, Fax: 021-8832704  
Vat: 4060111210 , Reg No: 1981/002231/07

Invoice Date 22/11/2019

To:  
Vat no: 4700102181  
Stellenbosch Munisipaliteit  
Trading As:  
P.O. Box 17  
Stellenbosch  
7599

Deliver To:  
Stellenbosch Munisipaliteit  
Trading As:  
The Magasyn Master  
Helshoogte  
Stellenbosch  
7599

Account No	Invoice Date	Order Number	Representative	DEL/POD	Reg Number	Page
S.MUN001	22/11/2019	357798	542 S-H Mothibi (FSR)	CL 22049		1 of 1

Item Code	Description	Quantity	UnitPrice	Disc %	VatAmnt	Line Total
C0001	Call Out - Normal Time	1.00	200.00		30.00	200.00
P0009	Puncture Repair Tube - Tractor Rear	1.00	250.00		37.50	250.00
P0009	Puncture Repair Tube - Tractor Front	1.00	250.00		37.50	250.00

*(Faint pink stamp with Afrikaans and English text regarding warranty and terms of sale)*

POD 11161  
KLAPMUTS OORLAAISTASIE  
CL 22049  
FITTERS PETROS/CASTRO  
21/11/2019

Subtotal (Exclusive)	700.00
Discount	
Vat	105.00
Total	805.00

Banking Details:  
First National Bank, Branch: 200610, Acc: 53750710536

EFT PAYMENTS ARE MORE SECURE AND WOULD BE APPRECIATED  
ACCOUNT TERMS: STRICTLY 30 DAYS FROM DATE OF STATEMENT AND CASH SALES  
STRICTLY CASH. INTEREST AT A RATE OF 20% PER ANNUM WILL BE CHARGED ON  
OVERDUE ACCOUNTS.

GOODS REMAIN THE PROPERTY OF KILOTREADS UNTIL PAID IN FULL AND WE  
RESERVE THE RIGHT OF REPOSSESSION

Print Name

Signature

*Handwritten signature and date: 4/12/19*  
**DONE**





mbosch

# AMPTELIKE BESTELLING OFFICIAL ORDER

STELLENBOSCH 7599  
021 808-8520  
021 808-8688

# Stellenbosch

MUNISIPALITEIT • UMASIPALA • MUNICIPALITY

BESTEL NR. / ORDER NO.

357798

DATUM / DATE

06/11/2019

KREDITEUR NR.  
CREDITORS NO. 001514

KONTAK PERSOON / CONTACT PERSON

MIRENCIA WILLIAMS  
Requisition No. 1064903

STREKKE STELLENBOSCH  
BIRD STREET  
STELLENBOSCH  
MIRN CAFE

LYN LINE	VOORRAAD NR. STOCK NO.	BESKRYWING / DESCRIPTION	POS NR. / VOTE NO	HOEVEELHEID QUANTITY	PRYSE SONDER BTW PRICES WITHOUT VAT	BTW/VAT	TOTALE PRYS TOTAL PRICE
		STB FD/SML6/19 SUPPLY D FIT OF TYRES AS AND	AN WHEN NEEDED	1 R	16698.70 2504.80	19203.50	

FOR: **STELLENBOSCH**  
HANDTEKENING  
SIGNATURE  
DEPARTEMENT  
DEPARTMENT

*[Handwritten Signature]*  
11.11.2019

TOTAAL  
TOTAL  
19203.50

dcmmrns.co.za



## P.O.D. / WORKSHEET

111161

PRL  STB

Cust. Company Name: Mun Date: 21/11/19  
 Cust. Company Telephone: \_\_\_\_\_ Fax: \_\_\_\_\_  
 Cust. Order No.: \_\_\_\_\_ Reg. / Fleet No.: U22049  
 Cust. Contact: \_\_\_\_\_ Cell No.: 7818992  
 Truck Km: \_\_\_\_\_ Time Arrived: 07:20 Time Completed: 08:59  
 Location: KIRK MITS

Quantity	Description	Taken from Stock		Signature
		Qty	Tyre Size	Serial No.
x	Call Out			
x	Demount & Fit		TYRE	
2x	Puncture Repair - Size		TUBE	
x	Wheel Rotation		GAITERS	
x	Fit New Tyre		BTS	
x	Fit Retread		BTS	
x	Fit Tube		BTS	
	Km Travelled			
	Tyre on : Size		Tyre on : Serial no.	Pos
				Tyre off : Serial No.

*[Handwritten notes in table: 12.5/20-18, 16.9-28, NO 5. FITTERS]*

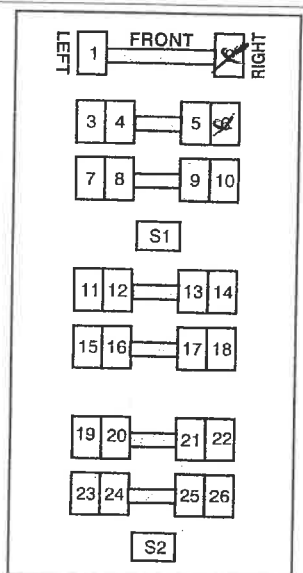

ALL MATERIALS USED REMAIN THE PROPERTY OF KILO TREADS UNTIL FULLY PAID FOR

Job done by Service Driver - Name: [Signature] Signature: [Signature]

All repairs and work carried out - checked and accepted.  
To be re-checked by Client / Driver after 100km as well.



Customer Driver Name: \_\_\_\_\_ Signature: \_\_\_\_\_ Invoice No.: \_\_\_\_\_

Barlinka - 872 1236



Kilotreads Stellenbosch (Pty) Ltd  
182 Bird Street, Stellenbosch, , 7600

Tel: 021-8873115, Fax: 021-8832704  
Vat: 4060111210 , Reg No: 1981/002231/07

Invoice Date 22/11/2019

To:  
Vat no: 4700102181  
Stellenbosch Munisipaliteit  
Trading As:  
P.O. Box 17  
Stellenbosch  
7599

Deliver To:  
Stellenbosch Munisipaliteit  
Trading As:  
The Magasyn Master  
Helshoogte  
Stellenbosch  
7599

Account No	Invoice Date	Order Number	Representative	DEL/POD	Reg Number	Page
S.MUN001	22/11/2019	357798	542 S-H Mothibi (FSR)	CL 22049		1 of 1

Item Code	Description	Quantity	UnitPrice	Disc %	VatAmnt	Line Total
C0001	Call Out - Normal Time	1.00	200.00		30.00	200.00
P0009	Puncture Repair Tube - Tractor FRONT	1.00	250.00		37.50	250.00

Herskryf / certifiseer dat / verklaar / bevestig dat  
VOTE / POS-NOMINATIE:

(a) Goede / Services identifiseer op die adres van die rekening.  
Goedere / Dienste geleverde op teende rekening is ontvang.  
(b) As per afrekenings verslag, alle uitgaves en ontvangste is verrekend tot die spesifiseerde bedrag tota. Goedere en dienste ontvangste is ontvang op die gespesifiseerde bedrag.  
(c) Alrekenings is afrekenend op die spesifiseerde bedrag.  
Wanneer goedere / dienste is ontvang, is die bedrag betaal.  
Expenditure received is in full, unless stated otherwise on the invoice.  
Uitgaves ontvangste is in volle bedrag ontvang op die spesifiseerde bedrag.

POD 11163  
KLAPMUTS OORLAAISTASIE  
CL 22049  
FITTEERS PETROS/CASTRO  
21/11/2019

Subtotal (Exclusive)	450.00
Discount	
Vat	67.50
Total	517.50

Banking Details:  
First National Bank, Branch: 200610, Acc: 53750710536

EFT PAYMENTS ARE MORE SECURE AND WOULD BE APPRECIATED  
ACCOUNT TERMS: STRICTLY 30 DAYS FROM DATE OF STATEMENT AND CASH SALES  
STRICTLY CASH. INTEREST AT A RATE OF 20% PER ANNUM WILL BE CHARGED ON  
OVERDUE ACCOUNTS.

GOODS REMAIN THE PROPERTY OF KILOTREADS UNTIL PAID IN FULL AND WE  
RESERVE THE RIGHT OF REPOSSESSION

Print Name

Signature

*[Handwritten Signature]* 4/12/19  
DON





# AMPTELIKE BESTELLING OFFICIAL ORDER

Page 813  
021 808-8520  
021 808-8688

# Stellenbosch

MUNISIPALITEIT • UMASIPALA • MUNICIPALITY

BESTEL NR. / ORDER NO.  
357799

DATUM / DATE  
06/11/2019

TREADS STELLENBOSCH  
BIRD STREET  
STELLENBOSCH  
TERN CAFE

KREDITEUR NR.  
CREDITORS NO. 001516

KONTAK PERSOON / CONTACT PERSON  
MIRENCIA WILLIAMS  
Requisition No. 1064903

LYN LINE	VOORRAAD NR. STOCK NO.	BESKRYWING / DESCRIPTION	POS NR / VOTE NO.	HOEVEELHEID QUANTITY	PRYSE SONDER BTW PRICES WITHOUT VAT	BTW/VAT	TOTALE PRYS TOTAL PRICE
		STB PD/SM16/19 SUPPLY D FIT OF TYRES AS AND	AN 1 WHEN NEEDED	164	R 2504.70	19203.50	

FOR: **STELLENBOSCH**  
HANDTEKENING SIGNATURE  
DEPARTEMENT DEPARTMENT

TOTAAL TOTAL  
19203.50

deprinte's.co.za

## P.O.D. / WORKSHEET 111163

PRL  STB

Cust. Company Name: MUN Date: 2/11/19  
Cust. Company Telephone: \_\_\_\_\_ Fax: \_\_\_\_\_  
Cust. Order No.: \_\_\_\_\_ Reg. / Fleet No.: CC 22049  
Cust. Contact: \_\_\_\_\_ Cell No.: 713 10 0000  
Truck Km: \_\_\_\_\_ Time Arrived: \_\_\_\_\_ Time Completed: \_\_\_\_\_  
Location: KIP MURS



Quantity	Description	Taken from Stock			Signature
		Qty	Tyre Size	Serial No.	
x	Call Out				
x	Demount & Fit		TYRE		
1 x	Puncture Repair - Size		TUBE		
x	Wheel Rotation		GAITERS		
x	Fit New Tyre		BTS		
x	Fit Retread		BTS		
x	Fit Tube		BTS		
	Km Travelled				
	Tyre on : Size		Tyre on : Serial no.	Pos	Tyre off : Serial No.

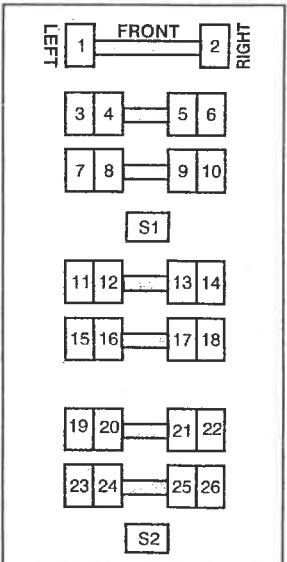

ALL MATERIALS USED REMAIN THE PROPERTY OF KILOTREADS UNTIL FULLY PAID FOR.

Job done by Service Driver - Name: Reddy Castro Signature: \_\_\_\_\_  
All repairs and work carried out - checked and accepted.  
To be re-checked by Client / Driver after 100km as well.



Barlinka - 872 1236

Customer Driver Name: \_\_\_\_\_ Signature: \_\_\_\_\_ Invoice No.: \_\_\_\_\_





Kilotreads Stellenbosch (Pty) Ltd  
182 Bird Street, Stellenbosch, , 7600

Tel: 021-8873115, Fax: 021-8832704  
Vat: 4060111210 , Reg No: 1981/002231/07

Invoice Date 27/11/2019

To:  
Vat no: 4700102181  
Stellenbosch Munisipaliteit  
Trading As:  
P.O. Box 17  
Stellenbosch  
7599

Deliver To:  
Stellenbosch Munisipaliteit  
Trading As:  
The Magasyn Master  
Helshoogte  
Stellenbosch  
7599

Account No	Invoice Date	Order Number	Representative	DEL/POD	Reg Number	Page
S.MUN001	27/11/2019	357798	542 S-H Mothibi (FSR)	ELB/MST DIGGER	CL 83465	1 of 1

Item Code	Description	Quantity	UnitPrice	Disc %	VatAmnt	Line Total
C0001	Call Out - Normal Time	1.00	200.00		30.00	200.00
P0007	Puncture Repair Tube - Tractor Front	1.00	250.00		37.50	250.00
P0009	Puncture Repair Tube - Tractor Rear	1.00	250.00		37.50	250.00

*(Handwritten notes in Afrikaans and English regarding warranty and terms of sale)*

POD 111263  
26/11/2019  
CL 83465  
ELB/MST DIGGER  
LOC:FRANSCHOEK  
OPERATOR:PIETER  
FITTERS:PATRICK&MORGAN

Subtotal (Exclusive)	700.00
Discount	
Vat	105.00
Total	805.00

Banking Details:  
First National Bank, Branch: 200610, Acc: 53750710536

EFT PAYMENTS ARE MORE SECURE AND WOULD BE APPRECIATED  
ACCOUNT TERMS: STRICTLY 30 DAYS FROM DATE OF STATEMENT AND CASH SALES  
STRICTLY CASH. INTEREST AT A RATE OF 20% PER ANNUM WILL BE CHARGED ON  
OVERDUE ACCOUNTS.

GOODS REMAIN THE PROPERTY OF KILOTREADS UNTIL PAID IN FULL AND WE  
RESERVE THE RIGHT OF REPOSSESSION

Print Name

Signature

*(Handwritten signature and date)*  
4/12/19  
DONQ





**AMPTELIKE BESTELLING  
OFFICIAL ORDER**

021 808-8520  
021 808-8688

**Stellenbosch**

MUNISIPALITEIT • UMASIPALA • MUNICIPALITY

**BESTEL NR. / ORDER NO.**  
357798

**DATUM / DATE**  
06/11/2019

OTREADS STELLENBOSCH  
BIRD STREET  
LLENBOSCH  
TERN CAPE

**KREDITEUR NR.  
CREDITORS NO.** 001516

**KONTAK PERSOON / CONTACT PERSON**  
MIRENCIA WILLIAMS  
Requisition No. 1064903

LINE	VOORRAAD NR. STOCK NO.	BESKRYWING / DESCRIPTION	POS NR. / VOTE NO.	HOEVEELHEID QUANTITY	PRYSE SONDER BTW PRICES WITHOUT VAT	BTW/VAT	TOTALE PRYS TOTAL PRICE
		STB FB/SML6/19 SUPPLY D FIT OF TYRES AS AND	AN 1 WHEN NEEDED	16698.70 R	2504.50	19203.50	

S / FOR: **STELLENBOSCH**

11.11.2019

HANDTEKENING  
SIGNATURE

DEPARTMENT  
DEPARTMENT

**TOTAAL  
TOTAL** 19203.50



**P.O.D. / WORKSHEET 111263**  PRL  STB

Cust. Company Name: Bellona/Munisipaliteit 26/11/2019

Cust. Company Telephone: \_\_\_\_\_ Fax: \_\_\_\_\_

Cust. Order No.: \_\_\_\_\_ Reg. / Fleet No.: CL83465

Cust. Contact: 2 Digger Voorwiel No: ELB/MST Digger

Truck Km: \_\_\_\_\_ Time Arrived: 10:45 Time Completed: 11:30

Location: Frauschoek

Quantity	Description	Taken from Stock			Signature
		Qty	Tyre Size	Serial No.	
x	Call Out				
x	Demount & Fit		TYRE		
x	Puncture Repair - Size	1	12.5/80R-18	puncture repair	
x	Wheel Rotation	2	12.5/80R-18	wheels put in	
x	Fit New Tyre		BTS		
x	Fit Retread	+1	12.5 MC OKO	put in Tyres	
x	Fit Tube		BTS		
	Km Travelled				
	Tyre on : Size		Tyre on : Serial no.	Pos	Tyre off : Serial No.

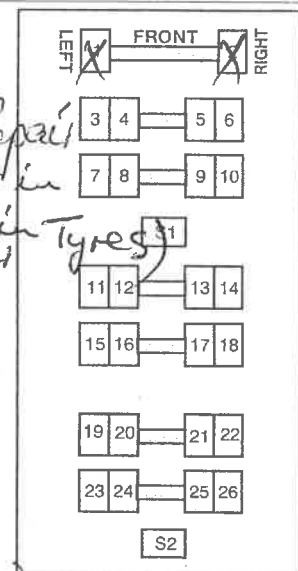

ALL MATERIALS USED REMAIN THE PROPERTY OF KILOTREADS UNTIL FULLY PAID FOR.

Job done by Service Driver - Name: Patrick Mosepo Signature: Rakana

All repairs and work carried out checked and accepted.  
To be re-checked by Client / Driver after 100km as well.

Customer Driver Name: Peter Signature: [Signature]



Invoice No.: SSA140828



Kilotreads Stellenbosch (Pty) Ltd  
182 Bird Street, Stellenbosch, , 7600

Tel: 021-8873115, Fax: 021-8832704  
Vat: 4060111210 , Reg No: 1981/002231/07

Invoice Date 28/11/2019

<p>To:</p> <p>Vat no: 4700102181</p> <p>Stellenbosch Munisipaliteit</p> <p>Trading As:</p> <p>P.O. Box 17</p> <p>Stellenbosch</p> <p>7599</p>	<p>Deliver To:</p> <p>Stellenbosch Munisipaliteit</p> <p>Trading As:</p> <p>The Magasyn Master</p> <p>Helshoogte</p> <p>Stellenbosch</p> <p>7599</p>
---	--

Account No	Invoice Date	Order Number	Representative	DEL/POD	Reg Number	Page
S.MUN001	28/11/2019	357798	542 S-H Mothibi (FSR)	ELB/MST	CL83465	1 of 1

Item Code	Description	Quantity	UnitPrice	Disc %	VatAmnt	Line Total
C0001	Call Out - Normal Time	1.00	200.00		30.00	200.00
P0007	Puncture Repair Tube - Tractor Front	1.00	250.00		37.50	250.00

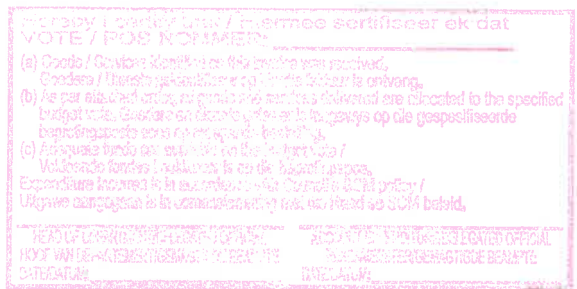

POD 111271  
27/11/2019  
CL 83465  
ELB /MST DIGGER  
POS:RF  
LOC:KLAPMUTS OORLAAI STASIE  
FITTERS:PATRICK&MORGAN

Subtotal (Exclusive)	450.00
Discount	
Vat	67.50
Total	517.50

Banking Details:  
First National Bank, Branch: 200610, Acc: 53750710536

EFT PAYMENTS ARE MORE SECURE AND WOULD BE APPRECIATED  
ACCOUNT TERMS: STRICTLY 30 DAYS FROM DATE OF STATEMENT AND CASH SALES  
STRICTLY CASH. INTEREST AT A RATE OF 20% PER ANNUM WILL BE CHARGED ON  
OVERDUE ACCOUNTS.

GOODS REMAIN THE PROPERTY OF KILOTREADS UNTIL PAID IN FULL AND WE  
RESERVE THE RIGHT OF REPOSSESSION

Print Name

Signature

*[Handwritten Signature]* 4/12/19  
DONE





Stellenbosch

# AMPTELIKE BESTELLING OFFICIAL ORDER

021 808-8520

021 808-8688

## Stellenbosch MUNISIPALITEIT • UMASIPALA • MUNICIPALITY

BESTEL NR. / ORDER NO.
357798

DATUM / DATE
06/11/2019

KREDITEUR NR. CREDITORS NO.
001514

KONTAK PERSOON / CONTACT PERSON
MIRENCHIA WILLIAMS
Requisition No. 1054903

OTREADS STELLENBOSCH  
1 BIRD STREET  
STELLENBOSCH  
WESTERN CAPE  
7600

LINE	VOORRAAD NR. STOCK NO.	BESKRYWING / DESCRIPTION	POS NR / VOTE NO.	HOEVEELHEID QUANTITY	PRYSE SONDER BTW PRICES WITHOUT VAT	BTW/VAT	TOTALE PRYS TOTAL PRICE
		STB FR/STML/19 SUPPLY D FIT OF TYRES AS AND	AN 1 WHEN NEEDED	1	16698.70	2504.80	19203.50

IS / FOR: **STELLENBOSCH**

11.11.2019

HANDTEKENING SIGNATURE

DEPARTEMENT DEPARTMENT

TOTAAL TOTAL

19203.50



Our business keeps you moving

### P.O.D. / WORKSHEET 111271 PRL STB

Cust. Company Name: Beltana/Munisipaliteit Date: 27/11/2019

Cust. Company Telephone: \_\_\_\_\_ Fax: \_\_\_\_\_

Cust. Order No.: \_\_\_\_\_ Reg. / Fleet No.: CB 8346S

Cust. Contact: Digger Voerwiel Cell No.: 06/4414895

Truck Km: \_\_\_\_\_ Time Arrived: 15:50 Time Completed: 16:42

Location: Klopwiel by Oorloaistad

Quantity	Description	Taken from Stock		Signature
		Qty	Tyre Size	Serial No.
X	Call Out			
X	Demount & Fit		TYRE	
X	Puncture Repair - Size	1	12.5/80R-18	Puncture Repair
X	Wheel Rotation		GAITERS	
X	Fit New Tyre		BTS	
X	Fit Retread		BTS	
X	Fit Tube		BTS	
	Km Travelled			
	Tyre on : Size		Tyre on : Serial no.	Pos
				Tyre off : Serial No.

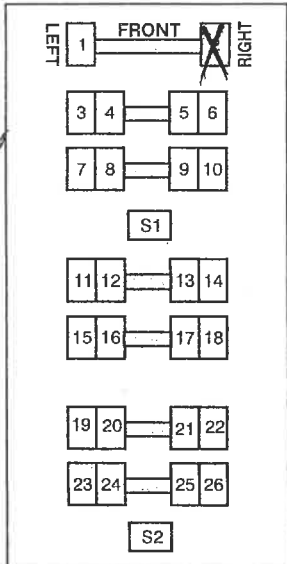

ALL MATERIALS USED REMAIN THE PROPERTY OF KILO TREADS UNTIL FULLY PAID FOR.

Job done by Service Driver - Name: Patrick Morgan Signature: Patrick Morgan

All repairs and work carried out - checked and accepted.  
To be re-checked by Client / Driver after 100km as well.

Customer Driver Name: \_\_\_\_\_ Signature: \_\_\_\_\_ Invoice No.: SSA140895



Barlinka - 872 1236



Kilotreads Stellenbosch (Pty) Ltd  
182 Bird Street, Stellenbosch, , 7600

Tel: 021-8873115, Fax: 021-8832704  
Vat: 4060111210 , Reg No: 1981/002231/07

Invoice Date 28/11/2019

To: Vat no: 4700102181 Stellenbosch Munisipaliteit Trading As: P.O. Box 17 Stellenbosch 7599	Deliver To: Stellenbosch Munisipaliteit Trading As: The Magasyn Master Helshoogte Stellenbosch 7599
--	---

Account No	Invoice Date	Order Number	Representative	DEL/POD	Reg Number	Page
S.MUN001	28/11/2019	357798	542 S-H Mothibi (FSR)	CL 27923	CL 27923	1 of 1

Item Code	Description	Quantity	UnitPrice	Disc %	VatAmnt	Line Total
F0003	Fitting with Sale - Truck Industrial	1.00	80.00		12.00	80.00

Heraby I certify that / Hiermee sertifiseer ek dat  
VOTE / POS NUMBER:

(a) Goods / Goedere beskryf op hierdie invoice moet word.  
Onder / Onder beskryfde goeder se faktuur is ontvang.

(b) As per attached order, all goods and services delivered are accounted to the specified  
budget code. Beside on order's copy or in copy of the goods/service  
beskryfde goeder se faktuur moet word.

(c) A separate fund can be used for the budget vote /  
Voorheen beskreë goeder kan in die faktuur gebruik word.  
Onderskryf funksie is in ooreenstemming met die SGM-reeks /  
Hierdie funksie is in ooreenstemming met die SGM-reeks.

POD 111211  
27/11/2019  
CL 27923  
COMPACTOR  
POS:9  
FITTER:PETER

Subtotal (Exclusive)	80.00
Discount	
Vat	12.00
Total	92.00

Banking Details:  
First National Bank, Branch: 200610, Acc: 53750710536

EFT PAYMENTS ARE MORE SECURE AND WOULD BE APPRECIATED  
ACCOUNT TERMS: STRICTLY 30 DAYS FROM DATE OF STATEMENT AND CASH SALES  
STRICTLY CASH. INTEREST AT A RATE OF 20% PER ANNUM WILL BE CHARGED ON  
OVERDUE ACCOUNTS.

GOODS REMAIN THE PROPERTY OF KILOTREADS UNTIL PAID IN FULL AND WE  
RESERVE THE RIGHT OF REPOSSESSION

Print Name \_\_\_\_\_ Signature  4/12/19  
DONALD





Stellenbosch

# AMPTELIKE BESTELLING OFFICIAL ORDER

021 808-8520  
021 808-8688

## Stellenbosch

MUNISIPALITEIT • UMASIPALA • MUNICIPALITY

BESTEL NR. / ORDER NO.  
257798

DATUM / DATE  
06/11/2019

TREADS STELLENBOSCH  
BIRD STREET  
STELLENBOSCH  
WESTERN CAPE  
7000

KREDITEUR NR.  
CREDITORS NO. 001516

KONTAK PERSOON / CONTACT PERSON  
MIRRENCTA WILLIAMS  
Requisition No. 1064903

ITEM / LINE	VOORRAAD NR. / STOCK NO.	BESKRYWING / DESCRIPTION	POS NR / VOTE NO.	HOEVEELHEID / QUANTITY	PRYSE SONDER BTW / PRICES WITHOUT VAT	BTW/VAT	TOTAAL PRYS / TOTAL PRICE
		STB FD/SR116/LP SUPPLY D FIT OF TYRES AS AND	AN 1 WHEN NEEDED	1	16698.70 R	2504.80	19203.50

S / FOR: STELLENBOSCH  
HANDTEKENING / SIGNATURE  
DEPARTEMENT / DEPARTMENT

TOTAAL TOTAL  
19203.50



### P.O.D. / WORKSHEET 111211 PRL STB

Cust. Company Name: MUN / SOLID WASTE Date: 27/10/19  
Cust. Company Telephone: \_\_\_\_\_ Fax: \_\_\_\_\_  
Cust. Order No.: \_\_\_\_\_ Reg. / Fleet No.: CL 27923  
Cust. Contact: \_\_\_\_\_ Cell No.: \_\_\_\_\_  
Truck Km: \_\_\_\_\_ Time Arrived: \_\_\_\_\_ Time Completed: \_\_\_\_\_  
Location: \_\_\_\_\_

Quantity	Description	Taken from Stock			Signature
		Qty	Tyre Size	Serial No.	
1	x Demount & Fit				
	x Puncture Repair - Size	TYRE	1	x 315/80R22.5 (OWN TYRE)	
	x Wheel Rotation	GAITERS			
	x Fit New Tyre	BTS			
	x Fit Retread	BTS			
	x Fit Tube	BTS			
	Km Travelled				
	Tyre on : Size	Tyre on : Serial no.	Pos	Tyre off : Serial No.	

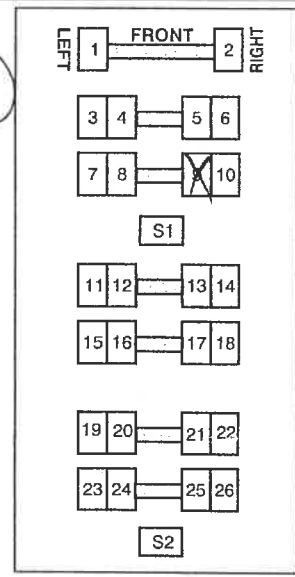

ALL MATERIALS USED REMAIN THE PROPERTY OF KILOTREADS UNTIL FULLY PAID FOR.  
Job done by Service Driver - Name: PETER Signature: \_\_\_\_\_

All repairs and work carried out - checked and accepted.  
To be re-checked by Client / Driver after 100km as well.  
Customer Driver Name: AAZ Signature: \_\_\_\_\_



Barlinka - 872 1236

Invoice No.: SSA140898



Kilotreads Stellenbosch (Pty) Ltd  
182 Bird Street, Stellenbosch, , 7600

Tel: 021-8873115, Fax: 021-8832704  
Vat: 4060111210 , Reg No: 1981/002231/07

Invoice Date 29/11/2019

To:  
Vat no: 4700102181  
Stellenbosch Munisipaliteit  
Trading As:  
P.O. Box 17  
Stellenbosch  
7599

Deliver To:  
Stellenbosch Munisipaliteit  
Trading As:  
The Magasyn Master  
Helshoogte  
Stellenbosch  
7599

Account No	Invoice Date	Order Number	Representative	DEL/POD	Reg Number	Page
S.MUN001	29/11/2019	357798	542 S-H Mothibi (FSR)	CL 83465	CL 83465	1 of 1

Item Code	Description	Quantity	UnitPrice	Disc %	VatAmnt	Line Total
C0001	Call Out - Normal Time	1.00	200.00		30.00	200.00
P0009	Puncture Repair Tube - Tractor Rear	1.00	250.00		37.50	250.00
P0007	Puncture Repair Tube - Tractor Front	1.00	250.00		37.50	250.00

Hereby I certify that / Hiermee sertifiseer ek dat  
VOTE / POS MOUWENS

(a) Goods / Services identified on this invoice are accurate.  
Goedere / Dienste geïdentifiseer op hierdie faktuur is akkuraat.

(b) As per attached copy of goods and services invoice we allocated to the specific  
budget code. Goodies en dienste wat op hierdie faktuur is geïdentifiseer is toegeken op die spesifieke  
begrotingskode wat op hierdie faktuur is.

(c) Any goods found are available for sale in the country.  
Waarheen die goeder is beskikbaar vir verkoop in die land.

Exp. and/or insured in the event of loss. Die goeder is oorsien /  
Uitgewas aangegewas in die geval van verlies of skade.

TRAC OF LOGISTICS (Pty) Ltd  
RYS WAREHOUSE (Pty) Ltd  
C/O TRAC

POD 111277  
28/11/2019  
CL 83465  
ELB/MST DIGGER  
LOC:SIMONDIUM GARAGE  
POS:LF & LR  
OPERATOR:PIETER  
EITERS-PATRICK&MORGAN

Subtotal (Exclusive)	700.00
Discount	
Vat	105.00
Total	805.00

Banking Details:  
First National Bank, Branch: 200610, Acc: 53750710536

EFT PAYMENTS ARE MORE SECURE AND WOULD BE APPRECIATED  
ACCOUNT TERMS: STRICTLY 30 DAYS FROM DATE OF STATEMENT AND CASH SALES  
STRICTLY CASH. INTEREST AT A RATE OF 20% PER ANNUM WILL BE CHARGED ON  
OVERDUE ACCOUNTS.

GOODS REMAIN THE PROPERTY OF KILOTREADS UNTIL PAID IN FULL AND WE  
RESERVE THE RIGHT OF REPOSSESSION

Print Name

Signature

*[Handwritten Signature]* 4/12/19  
DONE





Stellenbosch

# AMPTELIKE BESTELLING OFFICIAL ORDER

STELLENBOSCH 7599  
021 808-8520  
021 808-8688

# Stellenbosch

MUNISIPALITEIT • UMASIPALA • MUNICIPALITY

BESTEL NR. / ORDER NO.

357798

DATUM / DATE

06/11/2019

10 TREADS STELLENBOSCH  
1 BIRD STREET  
STELLENBOSCH  
WESTERN CAPE  
7599

KREDITEUR NR.  
CREDITORS NO. 001516

KONTAK PERSOON / CONTACT PERSON

MIRENCIA WILLIAMS  
Requisition No. 1064903

RE LINE / ONLINE	VOORRAAD NR. / STOCK NO.	BESKRYWING / DESCRIPTION	POS NR. / VOTE NO.	HOEVEELHEID / QUANTITY	PRYSE SONDER BTW / PRICES WITHOUT VAT	BTW/VAT	TOTALE PRYS / TOTAL PRICE
		STB PR/SML6/19 SUPPLY D FIT OF TYRES AS AND	AN 1 WHEN NEEDED	1	16698.70 R 2507.50	19203.50	

FOR: STELLENBOSCH  
HANDTEKENING SIGNATURE  
DEPARTEMENT DEPARTMENT

TOTAAL TOTAL  
19203.50



## P.O.D. / WORKSHEET 111277 PRL STB

Cust. Company Name: Beltang Munisipaliteit 28/11/2019  
Cust. Company Telephone: \_\_\_\_\_ Fax: \_\_\_\_\_  
Cust. Order No.: \_\_\_\_\_ Reg. / Fleet No.: CB 83465  
Cust. Contact: Digger voor en agter Fill No.: ELB/M/ST Digger  
Truck Km: \_\_\_\_\_ Time Arrived: 12:52 Time Completed: 13:15  
Location: Franschoek pad

Quantity	Description	Taken from Stock			Signature
		Qty	Tyre Size	Serial No.	
X	Call Out				
X	Demount & Fit		TYRE		
X	Puncture Repair - Size		TUBE		
X	Wheel Rotation		GAITERS		
X	Fit New Tyre		BTS		
X	Fit Retread		BTS		
X	Fit Tube		BTS		
	Km Travelled				
	Tyre on : Size		Tyre on : Serial no.	Pos	Tyre off : Serial No.

1 12.5/80-18 Puncture Repair  
(Put in No 4 gater inside)  
+1 16.9-28 Puncture Repair Aut.  
(Long plug in tyre.)

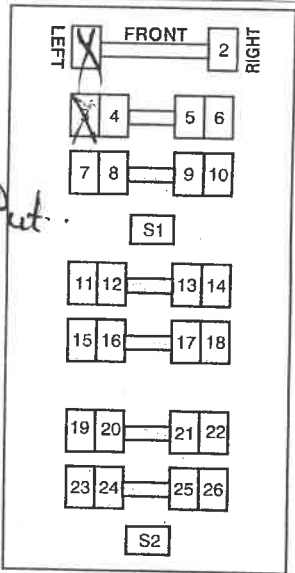

ALL MATERIALS USED REMAIN THE PROPERTY OF KILO TREADS UNTIL FULLY PAID FOR.

Job done by Service Driver - Name: Patrick Morgan Signature: Patrick Morgan

All repairs and work carried out - checked and accepted.  
To be re-checked by Client / Driver after 100km as well.

Customer Driver Name: [Signature] Signature: [Signature]



Invoice No.: SSA140938





Kilotreads Stellenbosch (Pty) Ltd  
182 Bird Street, Stellenbosch, , 7600

Tel: 021-8873115, Fax: 021-8832704  
Vat: 4060111210 , Reg No: 1981/002231/07

Invoice Date 29/11/2019

To:  
Vat no: 4700102181  
Stellenbosch Munisipaliteit  
Trading As:  
P.O. Box 17  
Stellenbosch  
7599

Deliver To:  
Stellenbosch Munisipaliteit  
Trading As:  
The Magasyn Master  
Helshoogte  
Stellenbosch  
7599

Account No	Invoice Date	Order Number	Representative	DEL/POD	Reg Number	Page
S.MUN001	29/11/2019	357798	542 S-H Mothibi (FSR)	CL 81470	ELB/MST	1 of 1

Item Code	Description	Quantity	UnitPrice	Disc %	VatAmnt	Line Total
C0001	Call Out - Normal Time	1.00	200.00		30.00	200.00
P0007	Puncture Repair Tube - Tractor Front	1.00	250.00		37.50	250.00

I hereby certify that / Hiermee swaakseer ek dat  
VOTE / POS NOKMER: \_\_\_\_\_

(a) Goods / Services are / is / on this invoice were received.  
Goedere / Diensle / dienste is / is / op hierdie faktuur is ontvang.

(b) As per invoice's / as per invoice's and invoice's conditions and conditions in the specified  
terms of sale. Ons is / ons is / op hierdie faktuur is ontvang op alle voorwaardes  
in die spesifieke terme van verkoop.

(c) I accept / I accept / I accept on the invoice /  
Ek aanvaar hierdie / ek aanvaar hierdie / ek aanvaar hierdie faktuur.

I understand / I understand / I understand the terms of the invoice /  
Ek verstaan / ek verstaan / ek verstaan die terme van die faktuur.

My payment / My payment / My payment is / is / on the invoice /  
My betaling / my betaling / my betaling is / is / op hierdie faktuur.

POD 111273  
ELB/MST DIGGER  
POS:LF  
LOC:BELTANA  
OPERATOR:NICHOLAS  
FITTERS:PATRICK&MORGAN  
CL 81470

Subtotal (Exclusive)	450.00
Discount	
Vat	67.50
Total	517.50

Banking Details:  
First National Bank, Branch: 200610, Acc: 53750710536

EFT PAYMENTS ARE MORE SECURE AND WOULD BE APPRECIATED  
ACCOUNT TERMS: STRICTLY 30 DAYS FROM DATE OF STATEMENT AND CASH SALES  
STRICTLY CASH. INTEREST AT A RATE OF 20% PER ANNUM WILL BE CHARGED ON  
OVERDUE ACCOUNTS.

GOODS REMAIN THE PROPERTY OF KILOTREADS UNTIL PAID IN FULL AND WE  
RESERVE THE RIGHT OF REPOSSESSION

Print Name

Signature

*[Handwritten Signature]* 4/2/19  
DONALD



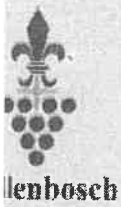

AMPTELIKE BESTELLING  
OFFICIAL ORDER

STELLENBOSCH 7599  
☎ 021 808-8520  
☎ 021 808-8688

# Stellenbosch

MUNISIPALITEIT • UMASIPALA • MUNICIPALITY

BESTEL NR. / ORDER NO.  
357798

DATUM / DATE  
06/11/2019

KILO TREADS STELLENBOSCH  
2 BIRD STREET  
STELLENBOSCH  
WESTERN CAPE  
7599

KREDITEUR NR.  
CREDITORS NO. 001516

KONTAK PERSOON / CONTACT PERSON  
MIRENCIA WILLIAMS  
Requisition No. 1064903

POS NR. / VOTE NO.	MOEVEELHEID / QUANTITY	PRYSE SONDER BTW / PRICES WITHOUT VAT	BTW/VAT	TOTALE PRYS / TOTAL PRICE
AN 1	1	16698.70	19203.50	
R		2504.80		

S / FOR: **STELLENBOSCH**  
 HANDTEKENING SIGNATURE  
 DEPARTEMENT DEPARTMENT

TOTAAL TOTAL  
19203.50



## P.O.D. / WORKSHEET 111273

Cust. Company Name: Beltana / Munisipaliteit  PRL  STB  
 Cust. Company Telephone: 3/waste Fax:  
 Cust. Order No.: CL81470 Reg. / Fleet No.:  
 Cust. Contact: Digger Voorwiel Cell No.: ELB/MST Digger  
 Truck Km: 8:14 Time Arrived: 8:14 Time Completed:  
 Location: Holshoogte pad.

Quantity	Description	Taken from Stock	Signature
		Qty Tyre Size Serial No.	
x	Call Out		
x	Demount & Fit		
x	Puncture Repair - Size	1 12.5/80-18	structure repair
x	Wheel Rotation		
x	Fit New Tyre		
x	Fit Retread		
x	Fit Tube		
	Km Travelled		
	Tyre on : Size	Tyre on : Serial no. Pos	Tyre off : Serial No.

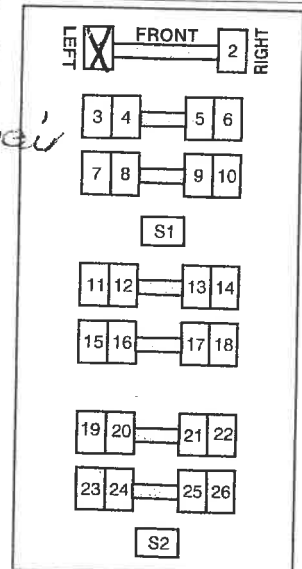

ALL MATERIALS USED REMAIN THE PROPERTY OF KILO TREADS UNTIL FULLY PAID FOR.

Job done by Service Driver - Name: Patrick Morgan Signature: [Signature]

All repairs and work carried out - checked and accepted.  
To be re-checked by Client / Driver after 100km as well.

Customer Driver Name: Nicholas Signature: [Signature]

Invoice No.:



Barlinka - 872 1236



Kilotreads Stellenbosch (Pty) Ltd  
182 Bird Street, Stellenbosch, , 7600

Tel: 021-8873115, Fax: 021-8832704  
Vat: 4060111210 , Reg No: 1981/002231/07

Invoice Date 30/11/2019

To:  
Vat no: 4700102181  
Stellenbosch Munisipaliteit  
Trading As:  
P.O. Box 17  
Stellenbosch  
7599

Deliver To:  
Stellenbosch Munisipaliteit  
Trading As:  
The Magasyn Master  
Helshoogte  
Stellenbosch  
7599

Account No	Invoice Date	Order Number	Representative	DEL/POD	Reg Number	Page
S.MUN001	30/11/2019	357798	542 S-H Mothibi (FSR)	CL 83465	CL 83465	1 of 1

Item Code	Description	Quantity	UnitPrice	Disc %	VatAmnt	Line Total
C0001	Call Out - Normal Time	1.00	200.00		30.00	200.00
P0007	Puncture Repair Tube - Tractor Front	1.00	250.00		37.50	250.00

NOTE / POS / REPOSSESSOR

(a) Goods / Services identified in this invoice are excluded from the VAT / POS / REPOSSESSOR scheme.

(b) As per attached note, all goods / services identified are excluded to the specified VAT / POS / REPOSSESSOR scheme. All payments on the goods / services identified are excluded to the specified VAT / POS / REPOSSESSOR scheme.

(c) All goods / services are excluded to the VAT / POS / REPOSSESSOR scheme. All payments on the goods / services identified are excluded to the specified VAT / POS / REPOSSESSOR scheme.

POD 111282  
29/11/2019  
CL 83465  
ELB/MST DIGGER  
POS:LF  
LOC:FRANSCHOEK  
OPERATOR:PIETER  
EITERS:PATRICK&MORGAN

Subtotal (Exclusive)	450.00
Discount	
Vat	67.50
Total	517.50

Banking Details:  
First National Bank, Branch: 200610, Acc: 53750710536

EFT PAYMENTS ARE MORE SECURE AND WOULD BE APPRECIATED  
ACCOUNT TERMS: STRICTLY 30 DAYS FROM DATE OF STATEMENT AND CASH SALES  
STRICTLY CASH. INTEREST AT A RATE OF 20% PER ANNUM WILL BE CHARGED ON  
OVERDUE ACCOUNTS.

GOODS REMAIN THE PROPERTY OF KILOTREADS UNTIL PAID IN FULL AND WE  
RESERVE THE RIGHT OF REPOSSESSION

Print Name \_\_\_\_\_ Signature *[Signature]* 4/12/19  
DONE





AMPTELIKE BESTELLING  
OFFICIAL ORDER

# Stellenbosch

MUNISIPALITEIT • UMASIPALA • MUNICIPALITY

BESTEL NR. / ORDER NO.  
357798

DATUM / DATE  
06/11/2019

OTREADS STELLENBOSCH  
17RD STREET  
STELLENBOSCH  
WESTERN CAPE  
7600

KREDITEUR NR.  
CREDITORS NO. 001516

KONTAK PERSOON / CONTACT PERSON  
PATRENCIA WILLIAMS  
Requisition No. 1064903

LINE	VOORRAAD NR. STOCK NO.	BESKRYWING / DESCRIPTION	POS NR. / VOTE NO.	HOEVEELHEID QUANTITY	PRYSE SONDER BTW PRICES WITHOUT VAT	BTW/VAT	TOTALE PRYS TOTAL PRICE
		STB FR/SML6/19 SUPPLY D FIT OF TYRES AS AND	AN 1 WHEN NEEDED	166	98.70	19203.50	
				R	2504.80		

FOR: STELLENBOSCH  
HANDTEKENING SIGNATURE  
DEPARTEMENT DEPARTMENT

TOTAAL TOTAL  
19203.50



P.O.D. / WORKSHEET 111282  PRL  STB  
Cust. Company Name: Beltana/Munisipaliteit 29/11/2019  
Cust. Company Telephone: \_\_\_\_\_ Fax: \_\_\_\_\_  
Cust. Order No.: \_\_\_\_\_ Reg. / Fleet No.: CU83465  
Cust. Contact: Digger Kowiel Cell No: ECB/WST Diggerloader  
Truck Km: \_\_\_\_\_ Time Arrived: 11:10 Time Completed: 11:45  
Location: Franschoek

Quantity	Description	Taken from Stock			Signature
		Qty	Tyre Size	Serial No.	
x	Call Out				
x	Demount & Fit		TYRE		
x	Puncture Repair - Size	1	12.5/80-18		
x	Wheel Rotation		GAITERS		
x	Fit New Tyre		BTS		
x	Fit Retread		BTS		
x	Fit Tube		BTS		
	Km Travelled				
	Tyre on : Size		Tyre on : Serial no.	Pos	Tyre off : Serial No.

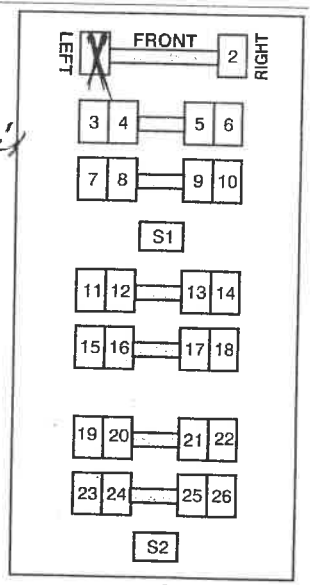

ALL MATERIALS USED REMAIN THE PROPERTY OF KILOTREADS UNTIL FULLY PAID FOR.

Job done by Service Driver - Name: Shrick Morgan Signature: [Signature]

All repairs and work carried out - checked and accepted.  
To be re-checked by Client/Driver after 100km as well.

Customer Driver Name: Frans Signature: [Signature]

**DUNLOP**  
Invoice No.: SSA140969

Tax Invoice



Kilotreads Stellenbosch (Pty) Ltd  
182 Bird Street, Stellenbosch, , 7600

Tel: 021-8873115, Fax: 021-8832704  
Vat: 4060111210 , Reg No: 1981/002231/07

Invoice Date 30/11/2019

To:

Vat no: 4700102181  
Stellenbosch Munisipaliteit  
Trading As:  
P.O. Box 17  
Stellenbosch  
7599

Deliver To:  
Stellenbosch Munisipaliteit  
Trading As:  
The Magasyn Master  
Helshoogte  
Stellenbosch  
7599

Account No	Invoice Date	Order Number	Representative	DEL/POD	Reg Number	Page
S.MUN001	30/11/2019	357798	542 S-H Mothibi (FSR)	CL22049	CL 22049	1 of 1

Item Code	Description	Quantity	UnitPrice	Disc %	VatAmnt	Line Total
C0001	Call Out - Normal Time	1.00	200.00		30.00	200.00
P0007	Puncture Repair Tube - Tractor Front	1.00	250.00		37.50	250.00

WATERSKOPPELINGSKONTOREK  
WATERSKOPPELINGSKONTOREK  
(a) WATERSKOPPELINGSKONTOREK...  
(b) WATERSKOPPELINGSKONTOREK...  
(c) WATERSKOPPELINGSKONTOREK...  
WATERSKOPPELINGSKONTOREK

POD 111197  
29/11/2019  
TLB LOADER  
CL 22049  
POS:RF  
LOC:KLAPMUTS OORLAAI STASIE  
FITTERS:PETROS&CASTRO

Subtotal (Exclusive)	450.00
Discount	
Vat	67.50
Total	517.50

Banking Details:  
First National Bank, Branch: 200610, Acc: 53750710536

EFT PAYMENTS ARE MORE SECURE AND WOULD BE APPRECIATED  
ACCOUNT TERMS: STRICTLY 30 DAYS FROM DATE OF STATEMENT AND CASH SALES  
STRICTLY CASH. INTEREST AT A RATE OF 20% PER ANNUM WILL BE CHARGED ON  
OVERDUE ACCOUNTS.

GOODS REMAIN THE PROPERTY OF KILOTREADS UNTIL PAID IN FULL AND WE  
RESERVE THE RIGHT OF REPOSSESSION

Print Name \_\_\_\_\_ Signature \_\_\_\_\_

4/12/19  
DONE



12.1.2	<b>CONSIDERATION OF EXPENDITURE INCURRED RELATING TO SERVICES RENDERED BY SIYAYA TYRES</b>
--------	--

Collaborator No:

IDP KPA Ref No:

Good Governance

Meeting Date:

05 November 2020 & 25 November 2020

**1. SUBJECT: CONSIDERATION OF EXPENDITURE INCURRED RELATING TO SERVICES RENDERED BY SIYAYA TYRES**

**2. PURPOSE OF REPORT**

To provide information regarding the expenditure incurred for investigation by MPAC and to be recommended for consideration by Council to ratify the expenditure in terms of the MFMA Section 32 (2). The expenditure with regard to the procurement of services for the supply, delivery, repair and fitment of tyres on various vehicles for Waste Management during the festive period in December 2019 is regarded as irregular because it breached the procurement process.

**3. DELEGATED AUTHORITY**

Council

**4. EXECUTIVE SUMMARY**

During the festive season of 2019, the period 24 December 2019 to 14 January 2020, Waste Management Services was required to render an essential service. A very important component of the waste management service is the transfer of all waste collected in the WC024, to Vissershok Private landfill in Cape Town. The transferring of waste from the Municipality to a landfill needs to be conducted without any interruption. The transferring of waste is reliant on a digger loader to load waste and the digger loader is prone to tyre punctures because of the sharp objects in the waste.

The former Foreman: Disposal from the Waste Management Department was responsible to ensure that the transfer station is operational had he required the services of a tyre company to repair and/or replace tyres. He requested the approval from the former Senior Manager: Mr Saliem Haider, (acting Director: Infrastructure Services at the time), to use the services of Siyaya Tyres to do repairs on the tyres. According to the former Foreman, Siyaya Tyres was the only company available during this time, as other companies had closed for the festive season. According to the then Senior Manager, a once off permission was granted, however the former Foreman interpreted the approval as on-going approval until a service provider had been appointed. The services of Siyaya Tyres were immediately terminated once this information came to light and a FQ process was initiated.

**5. RECOMMENDATION**

For MPAC consideration

**6. DISCUSSION**

The Solid Waste Management Department requires an external service provider to supply, deliver, repair and fit tyres on various vehicles utilised by this department. Waste collection and transport thereof remains a core functional activity for continued service delivery, and it is thus essential that the fleet is fitted with tyres fit and legally compliant to render the service to the public.

The procurement of a service provider was usually done via an FQ process. During the festive season of December 2019 no service provider had been appointed. The official in charge of the waste transfer station urgently needed tyre repairs to be done to ensure incoming waste was moved to Vissershok Waste Disposal facility.

The intent was in good faith as it was not on purpose, and in the interest of continued service delivery.

While the process was admittedly flawed, it is agreed that there was no *male fide*, personal gain or loss for Council, and it is requested that consideration be given to certify the expenditure as irrecoverable and that it be written off.

As recommended in similar recent instances, the need is recognised for improvement and correct procedures in general, with the need for a training program for all level of managers undertaking financial transactions on behalf of Council to be trained or retrained. It is especially important for staff to be informed of correct procedures and the implications of latest financial circulars, changes to policy, etc. The administration has requested the drafting of the necessary SOP's, which will also assist in removing the risk of a recurrence.

#### **7. FINANCIAL IMPLICATIONS**

Provision has been made from 20190703005940 in the 2019/20 budget for the amount of R 70 270.22 (VAT Incl.) (VAT incl.).

#### **8. LEGAL IMPLICATIONS**

The recommendations in this report comply with Council's policies and all applicable legislation

Supply Chain Management Policy, 4.36.1a (i)

Supply Chain Management Policy, 4.36.b

Supply Chain Regulation 36(1)

MFMA Section 32(2)

#### **9. RISK IMPLICATIONS**

All intent was in good faith, the breach can be attributed to the initial planning processes and the lack of capacity with regard to ensuring required financial compliances are adhered to.

#### **10. CONCLUSION**

It is acknowledged that there were minor breaches of the procurement processes. If the process was followed correctly however, the outcome and cost would have been identical. Council incurred no loss during this process and there was no intentional disregard of Council's procurement processes. It is therefore requested that the expenditure be written off because the services were rendered.

#### **11. COMMENTS FROM THE MUNICIPAL MANAGER**

Note the comments from the department, however in circumstances like the above; a deviation would have been the appropriate mechanism. Clear training to be given to this section as it is a recurring issue with regard to procedure not being followed. Counselling sessions to be arranged with relevant officials. Standard Operating Procedures to be workshopped with this section. Department should consider a tender dealing with tyres and repairs to prevent this as it is a recurring service. Municipality received the service and suffered no loss.

**12. COMMENTS FROM SUPPLY CHAIN MANAGER**

Supply Chain Management take note and will again communicate the SCM governance and compliance framework to all user departments

**MPAC MEETING: 2020-11-05: ITEM 5.2**

MPAC took note of the circumstances and facts as provided in the report, as well as the input from administration. MPAC is particularly pleased to note that Standard Operating Procedures are diligently being applied.

**RECOMMENDATIONS FROM MPAC TO COUNCIL: 2020-11-05: ITEM 5.2**

- (a) that Council certifies the irregular expenditure to the amount of R70 270,22 (excluding VAT) as irrecoverable; and
- (b) that Council writes off the irregular expenditure as irrecoverable in terms of the MFMA Section 32(2).

**ANNEXURE**

Annexure A: Invoices

**FOR FURTHER DETAILS CONTACT:**

<b>NAME</b>	Deon Louw
<b>POSITION</b>	<i>Director: Infrastructure Services</i>
<b>DIRECTORATE</b>	<i>Infrastructure Services</i>
<b>CONTACT NUMBERS</b>	<i>021 808 8213</i>
<b>E-MAIL ADDRESS</b>	<i><u><a href="mailto:Deon.louw@stellenbosch.gov.za">Deon.louw@stellenbosch.gov.za</a></u></i>
<b>REPORT DATE</b>	<i>15 October 2020</i>



# **ANNEXURE A**



**MEMO**  
**DEPARTMENT OF INFRASTRUCTURE SERVICES**  
**DEPARTEMENT VAN INFRASTRUKTUURDIENSTE**

**TO:** Chief Financial Officer  
Kevin Carolus

**FROM:** Acting Snr Manager: Waste Management  
Clayton Hendricks

**DATE:** 13 May 2020

**SUBJECT:** APPROVAL OF PAYMENT: SIYAYA TYRES – REPAIR TYRE PUNCTURES AS AND WHEN REQUIRED

---

**PURPOSE**

To obtain approval to process the payment of the outstanding invoices for Siyaya Tyres.

**BACKGROUND**

The official in charge of the Klapmuts Waste transfer Station was negligent and allowed the fitment and repair of tyres without an official order number. The services of Siyaya (Pty) Ltd were immediately terminated once this information came to light and a FQ process was initiated.

**RECOMMENDATION**

That approval is granted to pay the outstanding invoices to the value of R70 270.22 (VAT incl).

Clayton Hendricks

Acting Senior Manager: Waste Management

Date: 21/05/2020

Supported / ~~Not supported~~



---

Deon Louw

Director: Infrastructure Services

Date: 25/5/2020

Approved / Not approved

---

Kevin Carolus

Chief Financial Officer: Finance

Date:

# Statement

**SIYAYA TYRES**  
 135-139 Commercial Road  
 Sidwell  
 Port Elizabeth  
 6000

<b>Telephone</b>	041 - 453 2198
<b>Fax</b>	041 - 451 2678
<b>Date</b>	31/03/2020
<b>Amount Due</b>	<b>70,270.22</b>

**STELLMUN001**  
**Stellenbosch Munisipaliteit**  
 P O Box 17  
 Stellenbosch

Current

7599

<u>Date</u>	<u>Reference</u>	<u>Description</u>	<u>Allocated To</u>	<u>Debit</u>	<u>Credit</u>	<u>Balance</u>
01/02/2020		Balance Brought Forward		9,327.23		9,327.23
13/03/2020	INV309 ✓	Invoice		1,439.16		10,766.39
13/03/2020	INV310 ✓	Invoice		1,215.20		11,981.59
13/03/2020	INV311 ✓	Invoice		1,439.16		13,420.75
13/03/2020	INV312 ✓	Invoice		1,728.55		15,149.30
13/03/2020	INV313 ✓	Invoice		1,965.67		17,114.97
13/03/2020	INV314 ✓	Invoice		984.02		18,098.99
13/03/2020	INV315 ✓	Invoice		1,372.88		19,471.87
13/03/2020	INV316 ✓	Invoice		1,439.16		20,911.03
13/03/2020	INV317 ✓	Invoice		1,439.16		22,350.19
13/03/2020	INV318 ✓	Invoice		1,998.87		24,349.06
13/03/2020	INV319 ✓	Invoice		1,299.39		25,648.45
13/03/2020	INV320 ✓	Invoice		746.90		26,395.35
13/03/2020	INV321 ✓	Invoice		1,256.70		27,652.05
13/03/2020	INV322 ✓	Invoice				29,821.64

<b>180 Days</b>	<b>150 Days</b>	<b>120 Days</b>	<b>90 Days</b>	<b>60 Days</b>	<b>30 Days</b>	<b>Current</b>	<b>Amount Due</b>
(0.02)	0.00	0.00	1,480.63	0.00	0.00	68,789.61	<b>70,270.22</b>

**STELLMUN001**  
**Stellenbosch Munisipaliteit**  
 P O Box 17  
 Stellenbosch

**SIYAYA TYRES**  
 Sidwell

7599

<b>180 Days</b>	<b>150 Days</b>	<b>120 Days</b>	<b>90 Days</b>	<b>60 Days</b>	<b>30 Days</b>	<b>Current</b>	<b>Amount Due</b>
(0.02)	0.00	0.00	1,480.63	0.00	0.00	68,789.61	<b>70,270.22</b>

# Statement

**SIYAYA TYRES**

135-139 Commercial Road  
Sidwell  
Port Elizabeth  
6000

**Telephone**

041 - 453 2198

**Fax**

041 - 451 2678

**Date**

31/03/2020

**Amount Due****70,270.22****STELLMUN001****Stellenbosch Munisipaliteit**

P O Box 17  
Stellenbosch

Current

7599

<u>Date</u>	<u>Reference</u>	<u>Description</u>	<u>Allocated To</u>	<u>Debit</u>	<u>Credit</u>	<u>Balance</u>
		Brought forward from previous page				48,493.08
16/03/2020	INV336 ✓	Invoice		1,517.52		47,841.01
16/03/2020	INV337 ✓	Invoice		924.74		48,765.75
16/03/2020	INV338 ✓	Invoice		2,110.30		50,876.05
16/03/2020	INV339 ✓	Invoice		4,125.77		55,001.82
30/03/2020	INV343	Invoice		11,557.51		66,559.33
30/03/2020	INV344 ✓	Invoice		11,557.51		78,116.84
11/02/2020	BS842/11/02	PMT - THANK YOU - 298/300/301/302			5,418.58	72,698.26
12/03/2020	BS855/12/03	PMT - THANK YOU - 287/288/299			6,568.04	66,130.22
12/03/2020	JNL279	JD-INCORRECT ACC FOR CRN		4,140.00		70,270.22

180 Days	150 Days	120 Days	90 Days	60 Days	30 Days	Current	Amount Due
(0.02)	0.00	0.00	1,480.63	0.00	0.00	68,789.61	<b>70,270.22</b>

**STELLMUN001****Stellenbosch Munisipaliteit**

P O Box 17  
Stellenbosch

**SIYAYA TYRES**

Sidwell

7599

180 Days	150 Days	120 Days	90 Days	60 Days	30 Days	Current	Amount Due
(0.02)	0.00	0.00	1,480.63	0.00	0.00	68,789.61	<b>70,270.22</b>

## Tax Invoice

## SIYAYA TYRES

135-139 Commercial Road  
Sidwell  
Port Elizabeth

Tax Registration **4710176308**  
Telephone **041 - 453 2198**  
Fax **041 - 451 2678**

To:

STELLMUN001

Stellenbosch Munisipaliteit

P O Box 17  
Stellenbosch  
7599

Tax Registration **4700102181**

Account	Date	Order No	Delivery Note	Our Reference
STELLMUN001	13/03/2020			INV321

Item Code	Item Description	Quantity	Unit	Price (Ex)	Disc %	Tax	Total (Incl)
CC/OUT	CALL OUT FEE	1.00		392.00		58.80	450.80
FITTED	FITTED / STRIP	1.00		206.19		30.93	237.12
PUN/TRAC	P/REPAIRS TRAC Rear 24' to 38'	1.00		206.19		30.93	237.12
TRAV	TRAVEL COST PER KM	40.00		7.21		43.26	331.66

DONE BY SAFETY GRIP  
KLAPMUTS  
CL 83193  
27/12/19  
POS 3

Received by \_\_\_\_\_  
Date \_\_\_\_\_  
Signed \_\_\_\_\_

Total (Excl) 1,092.78  
Tax 163.92  
**Total 1,256.70**  
Discount 0.00  
**Total (Incl) 1,256.70**

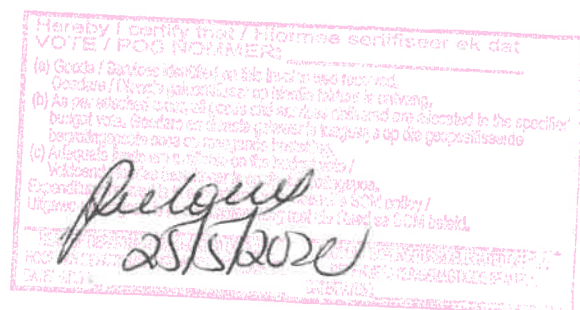
# Tax Invoice

**SIYAYA TYRES**  
 135-139 Commercial Road  
 Sidwell  
 Port Elizabeth

Tax Registration **4710176308**  
 Telephone **041 - 453 2198**  
 Fax **041 - 451 2678**

**To:**  
**STELLMUN001**  
**Stellenbosch Munisipaliteit**  
 P O Box 17  
 Stellenbosch  
 7599

Tax Registration **4700102181**

Account	Date	Order No	Delivery Note	Our Reference
STELLMUN001	13/03/2020			INV309

Item Code	Item Description	Quantity	Unit	Price (Ex)	Disc %	Tax	Total (Incl)
TRAV	TRAVEL COST PER KM	54.00		7.22		58.48	448.36
CC/OUT	CALL OUT FEE	1.00		397.65		59.65	457.30
FITTED	FITTED / STRIP	1.00		206.18		30.93	237.11
PUN/TRAC	P/REPAIRS TRAC Rear 24' to 38'	1.00		257.73		38.66	296.39

DONE BY SAFETYGRRIP  
 KLAPMUTS  
 CL 22049  
 28/12/19  
 POS 2

Total (Excl)	1,251.44
Tax	187.72
<b>Total</b>	<b>1,439.16</b>
Discount	0.00
<b>Total (Incl)</b>	<b>1,439.16</b>

Received by \_\_\_\_\_  
 Date \_\_\_\_\_  
 Signed \_\_\_\_\_

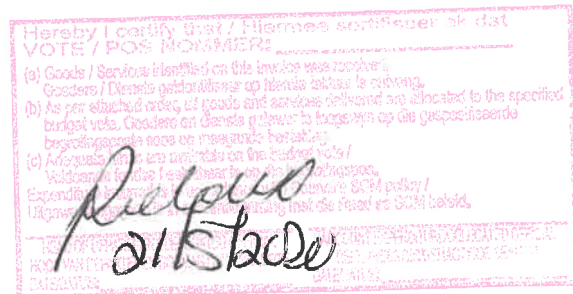

# Tax Invoice

**SIYAYA TYRES**  
 135-139 Commercial Road  
 Sidwell  
 Port Elizabeth

Tax Registration **4710176308**  
 Telephone **041 - 453 2198**  
 Fax **041 - 451 2678**

To:  
**STELLMUN001**  
**Stellenbosch Munisipaliteit**  
 P O Box 17  
 Stellenbosch  
 7599

Tax Registration **4700102181**

Account	Date	Order No	Delivery Note	Our Reference
STELLMUN001	13/03/2020			INV310

Item Code	Item Description	Quantity	Unit	Price (Ex)	Disc %	Tax	Total (Incl)
CC/OUT	CALL OUT FEE	1.00		391.75		58.76	450.51
TRAV	TRAVEL COST PER KM	30.00		7.22		32.49	249.09
FITTED	FITTED / STRIP	1.00		206.19		30.93	237.12
PUN/TRAC	P/REPAIRS TRAC Rear 24' to 38'	1.00		242.16		36.32	278.48

DONE BY SAFETY GRIP  
 KLAPMUTS  
 27/12/19  
 CL 81470  
 POS 2

Total (Excl)	1,056.70
Tax	158.50
<b>Total</b>	<b>1,215.20</b>
Discount	0.00
<b>Total (Incl)</b>	<b>1,215.20</b>

Received by \_\_\_\_\_  
 Date \_\_\_\_\_  
 Signed \_\_\_\_\_

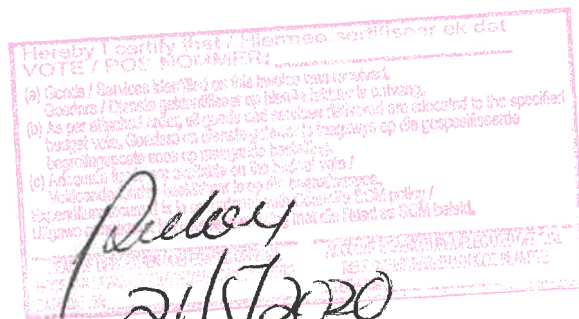



# Tax Invoice

**SIYAYA TYRES**  
 135-139 Commercial Road  
 Sidwell  
 Port Elizabeth

Tax Registration **4710176308**  
 Telephone **041 - 453 2198**  
 Fax **041 - 451 2678**

To:  
**STELLMUN001**  
**Stellenbosch Munisipaliteit**  
 P O Box 17  
 Stellenbosch  
 7599

Tax Registration **4700102181**

Account	Date	Order No	Delivery Note	Our Reference
STELLMUN001	13/03/2020			INV311

Item Code	Item Description	Quantity	Unit	Price (Ex)	Disc %	Tax	Total (Incl)
CC/OUT	CALL OUT FEE	1.00		397.65		59.65	457.30
TRAV	TRAVEL COST PER KM	54.00		7.22		58.48	448.36
FITTED	FITTED / STRIP	1.00		206.18		30.93	237.11
PUN/TRAC	P/REPAIRS TRAC Rear 24' to 38'	1.00		257.73		38.66	296.39

DONE BY SAFETY GRIP  
 KLAPMUTS  
 CL 22049  
 28/12/19  
 POS 2

Total (Excl)	1,251.44
Tax	187.72
<b>Total</b>	<b>1,439.16</b>
Discount	0.00
<b>Total (Incl)</b>	<b>1,439.16</b>

Received by \_\_\_\_\_  
 Date \_\_\_\_\_  
 Signed \_\_\_\_\_

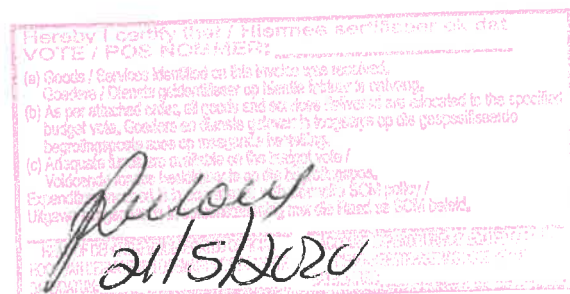
# Tax Invoice

**SIYAYA TYRES**  
 135-139 Commercial Road  
 Sidwell  
 Port Elizabeth

Tax Registration **4710176308**  
 Telephone **041 - 453 2198**  
 Fax **041 - 451 2678**

To:  
**STELLMUN001**  
**Stellenbosch Munisipaliteit**  
 P O Box 17  
 Stellenbosch  
 7599

Tax Registration **4700102181**

Account	Date	Order No	Delivery Note	Our Reference
STELLMUN001	13/03/2020			INV312

Item Code	Item Description	Quantity	Unit	Price (Ex)	Disc %	Tax	Total (Incl)
CC/OUT	CALL OUT FEE	1.00		397.65		59.65	457.30
TRAV	TRAVEL COST PER KM	54.00		7.21		58.40	447.74
FITTED	FITTED / STRIP	1.00		206.18		30.93	237.11
PUN/TRAC	P/REPAIRS TRAC Rear 24' to 38'	2.00		254.97		76.49	586.43

DONE BY SAFETY GRIP  
 KLAPMUTS  
 31/12/19  
 CL 22049  
 POS 1

Total (Excl)	1,503.11
Tax	225.47
<b>Total</b>	<b>1,728.58</b>
Discount	0.00
<b>Total (Incl)</b>	<b>1,728.55</b>

Received by \_\_\_\_\_  
 Date \_\_\_\_\_  
 Signed \_\_\_\_\_



Hereby I certify that / Hiermee verklaar ek dat  
**VOTE / POS BOMMER:**

(a) Goods / Services listed on this invoice was received.  
 Goedere / Dienste gelyktydig op hierdie faktuur is ontvang.

(b) As per attached order, all goods and services received are allocated to the specified budget vote. Cosiens en dienste gelyktydig op hierdie faktuur is op die gespesifiseerde begrotingsposisie teen op teëwagte teëvalle.

(c) Adequate funds are made available for budget vote /  
 voldoende finansiële beskikbaarheid is gemaak vir die begrotingsposisie.  
 Ekspenditoure hierop is in ooreenstemming met die gespesifiseerde begrotingsposisie.  
 Uitgawes word gemaak op ooreenstemming met die gespesifiseerde begrotingsposisie.

READY TO PARTNER WITH YOU  
 HOOP OM SAAM TE WERK  
 DATUM: 13/03/2020

# Tax Invoice

**SIYAYA TYRES**  
 135-139 Commercial Road  
 Sidwell  
 Port Elizabeth

Tax Registration **4710176308**  
 Telephone **041 - 453 2198**  
 Fax **041 - 451 2678**

To:  
**STELLMUN001**  
**Stellenbosch Munisipaliteit**  
 P O Box 17  
 Stellenbosch  
 7599

Tax Registration **4700102181**

Account	Date	Order No	Delivery Note	Our Reference
STELLMUN001	13/03/2020			INV313

Item Code	Item Description	Quantity	Unit	Price (Ex)	Disc %	Tax	Total (Incl)
CC/OUT	CALL OUT FEE	1.00		397.66		59.65	457.31
TRAV	TRAVEL COST PER KM	54.00		7.22		58.48	448.36
FITTED	FITTED / STRIP	2.00		206.18		61.85	474.21
PUN/TRAC	P/REPAIRS TRAC Rear 24' to 38'	2.00		254.69		76.41	585.79

DONE BY SAFETYGRIP  
 KLAPMUTS  
 30/12/19  
 CL 22049  
 POS 2

Total (Excl)	1,709.28
Tax	256.39
<b>Total</b>	<b>1,965.67</b>
Discount	0.00
<b>Total (Incl)</b>	<b>1,965.67</b>

Received by \_\_\_\_\_  
 Date \_\_\_\_\_  
 Signed \_\_\_\_\_

Handy / certifikat / nimmee seertifikaat op dat  
**VOTE / POS NUMMER:** \_\_\_\_\_

(a) Goods / Services identified on this invoice was received.  
 Goedere / Diensse geïdentifiseer op hierdie faktuur is ontvang.

(b) As per attached return, all goods and services rendered are allocated to the specified  
 budget vote, allocated on demand, unless in budgetary or the respective  
 budgetary control area or otherwise stated.

(c) Adequately (a) and (b) on the budget vote /  
 Voltoes (a) en (b) op die begrotingpost.

Expenditure / uitgawes is volgens die begrotingpost /  
 Uitgawes is volgens die begrotingpost.

13/03/2020

# Tax Invoice

**SIYAYA TYRES**  
 135-139 Commercial Road  
 Sidwell  
 Port Elizabeth

Tax Registration **4710176308**  
 Telephone **041 - 453 2198**  
 Fax **041 - 451 2678**

**To:**  
**STELLMUN001**  
**Stellenbosch Munisipaliteit**  
 P O Box 17  
 Stellenbosch  
 7599

Tax Registration **4700102181**

Account	Date	Order No	Delivery Note	Our Reference
STELLMUN001	13/03/2020			INV314

Item Code	Item Description	Quantity	Unit	Price (Ex)	Disc %	Tax	Total (Incl)
CC/OUT	CALL OUT FEE	1.00		397.65		59.65	457.30
FITTED	FITTED / STRIP	1.00		206.19		30.93	237.12
PUN/TRAC	P/REPAIRS TRAC Rear 24' to 38'	1.00		251.83		37.77	289.60

DONE BY SAFETYGRIP  
 KLAPMUTS  
 31/12/19  
 CL 81470  
 POS 1

Total (Excl)	855.67
Tax	128.35
<b>Total</b>	<b>984.02</b>
Discount	0.00
<b>Total (Incl)</b>	<b>984.02</b>

Received by \_\_\_\_\_

Date \_\_\_\_\_

Signed \_\_\_\_\_

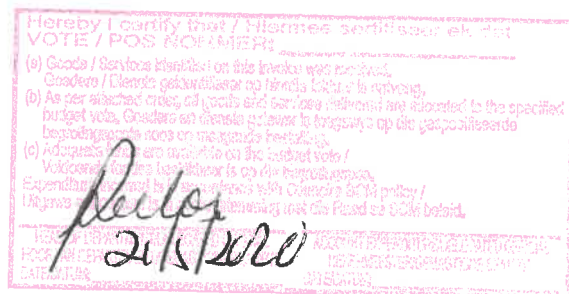
## Tax Invoice

**SIYAYA TYRES**  
135-139 Commercial Road  
Sidwell  
Port Elizabeth

Tax Registration **4710176308**  
Telephone **041 - 453 2198**  
Fax **041 - 451 2678**

To:  
**STELLMUN001**  
**Stellenbosch Munisipaliteit**  
P O Box 17  
Stellenbosch  
7599

Tax Registration **4700102181**

Account	Date	Order No	Delivery Note	Our Reference
STELLMUN001	13/03/2020			INV315

Item Code	Item Description	Quantity	Unit	Price (Ex)	Disc %	Tax	Total (Incl)
CC/OUT	CALL OUT FEE	1.00		392.10		58.82	450.92
FITTED	FITTED / STRIP	1.00		206.18		30.93	237.11
PUN/TR	P/REPAIRS TRAC Front 16' to 18	1.00		206.18		30.93	237.11
TRAV	TRAVEL COST PER KM	54.00		7.21		58.40	447.74

DONE BY SAFETY GRIP  
KLAPMUTS  
SL 81470  
2/1/20  
POS 1

Total (Excl)	1,193.80
Tax	179.08
<b>Total</b>	<b>1,372.88</b>
Discount	0.00
<b>Total (Incl)</b>	<b>1,372.88</b>

Received by \_\_\_\_\_

Date \_\_\_\_\_

Signed \_\_\_\_\_

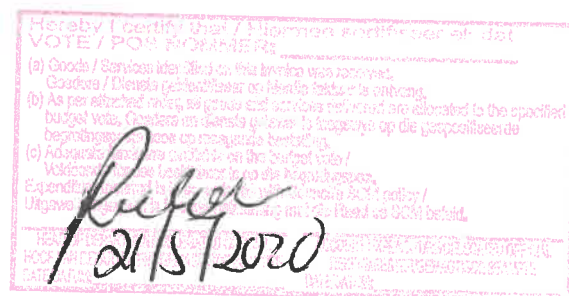
# Tax Invoice

**SIYAYA TYRES**  
 135-139 Commercial Road  
 Sidwell  
 Port Elizabeth

Tax Registration **4710176308**  
 Telephone **041 - 453 2198**  
 Fax **041 - 451 2678**

To:  
**STELLMUN001**  
**Stellenbosch Munisipaliteit**  
 P O Box 17  
 Stellenbosch  
 7599

Tax Registration **4700102181**

Account	Date	Order No	Delivery Note	Our Reference
STELLMUN001	13/03/2020			INV316

Item Code	Item Description	Quantity	Unit	Price (Ex)	Disc %	Tax	Total (Incl)
CC/OUT	CALL OUT FEE	1.00		397.65		59.65	457.30
TRAV	TRAVEL COST PER KM	54.00		7.22		58.48	448.36
FITTED	FITTED / STRIP	1.00		206.18		30.93	237.11
PUN/TRAC	P/REPAIRS TRAC Rear 24' to 38'	1.00		257.73		38.66	296.39

DONE BY SAFETY GRIP  
 KLAPMUTS  
 28/12/19  
 CL 81470  
 POS 1

Total (Excl)	1,251.44
Tax	187.72
<b>Total</b>	<b>1,439.16</b>
Discount	0.00
<b>Total (Incl)</b>	<b>1,439.16</b>

Received by \_\_\_\_\_  
 Date \_\_\_\_\_  
 Signed \_\_\_\_\_



Hereby I certify that / Hiermee verklaar ek dat  
**VOTE / POS NOUMER:**

(a) Goods / Services identified on this invoice were received.  
 Goedere / dienste geïdentifiseer op hierdie faktuur is ontvang.

(b) As per attached order and goods and services delivered are allocated to the specified budget vote, Condition Grants gateway to manage op die spesifiseerde begrotingskode nou op te teken, verhandel.

(c) Adequate funds are available on the budget vote / voldoende finansiële beskikbaar is op die begrotingskode.

Expenditure incurred by the Company is in accordance with the relevant financial regulations.  
 Uitgawe gemaak deur die Maatskappij is in ooreenstemming met die relevante finansiële regulasies.

HEAD OFFICE: 135-139 COMMERCIAL ROAD, SIDWELL, PORT ELIZABETH, 6001  
 BRANCH OFFICE: 135-139 COMMERCIAL ROAD, SIDWELL, PORT ELIZABETH, 6001

*perfor*  
 24/5/2020

# Tax Invoice

**SIYAYA TYRES**  
 135-139 Commercial Road  
 Sidwell  
 Port Elizabeth

Tax Registration **4710176308**  
 Telephone **041 - 453 2198**  
 Fax **041 - 451 2678**

To:  
**STELLMUN001**  
**Stellenbosch Munisipaliteit**  
 P O Box 17  
 Stellenbosch  
 7599

Tax Registration **4700102181**

Account	Date	Order No	Delivery Note	Our Reference
STELLMUN001	13/03/2020			INV317

Item Code	Item Description	Quantity	Unit	Price (Ex)	Disc %	Tax	Total (Incl)
CC/OUT	CALL OUT FEE	1.00		397.65		59.65	457.30
TRAV	TRAVEL COST PER KM	54.00		7.22		58.48	448.36
FITTED	FITTED / STRIP	1.00		206.18		30.93	237.11
PUN/TRAC	P/REPAIRS TRAC Rear 24' to 38'	1.00		257.73		38.66	296.39

DONE BY SAFETY GRIP  
 KLAPMUTS  
 CL 81470  
 POS 1  
 27/12/19

Total (Excl)	1,251.44
Tax	187.72
<b>Total</b>	<b>1,439.16</b>
Discount	0.00
<b>Total (Incl)</b>	<b>1,439.16</b>

Received by \_\_\_\_\_  
 Date \_\_\_\_\_  
 Signed \_\_\_\_\_



Hereby I certify that / Hiermee sertifiseer ek dat  
 VOTE / POS NUMBER: \_\_\_\_\_

(a) Goods / Services identified on this invoice were received.  
 Goedere / Diensies geïdentifiseer op hierdie faktuur is ontvang.

(b) As per attached order, all goods and services rendered are allocated to the specified budget vote. / Soos vermeld op die ooreenkomstige bestel, is alle goeder en dienste geïdentifiseer op die spesifiseerde begrotingsstemming.

(c) Adequately supported by the budget vote / Voldoende ondersteun deur die begrotingsstemming.

Expenses incurred in accordance with Council's SCM policy / Uitgawes gemaak in ooreenstemming met die Raad se SOG se beleid.

**21/3/2020**

TEKST: 20200313 12:58:21  
 HOOFKANTOR: 135-139 COMMERCIAL ROAD, SIDWELL, PORT ELIZABETH, 6001  
 E-MAIL: info@siyaya.co.za

## Tax Invoice

## SIYAYA TYRES

135-139 Commercial Road  
Sidwell  
Port Elizabeth

To:

STELLMUN001

Stellenbosch Munisipaliteit

P O Box 17

Stellenbosch

7599

Tax Registration 4710176308

Telephone 041 - 453 2198

Fax 041 - 451 2678

Tax Registration 4700102181

Account	Date	Order No	Delivery Note	Our Reference
STELLMUN001	13/03/2020			INV318

Item Code	Item Description	Quantity	Unit	Price (Ex)	Disc %	Tax	Total (Incl)
CC/OUT	CALL OUT FEE	1.00		395.99		59.40	455.39
FITTED	FITTED / STRIP	2.00		206.18		61.85	474.21
PUN/TRAC	P/REPAIRS TRAC Rear 24' to 38'	2.00		255.52		76.66	587.70
TRAV	TRAVEL COST PER KM	58.00		7.22		62.81	481.57

DONE BY SAFETYGRIP  
KLAPMUTS  
CL 22049 EN CL 81470  
26/12/19  
POS 2 EN 3

Total (Excl)	1,738.15
Tax	260.72
<b>Total</b>	<b>1,998.87</b>
Discount	0.00
<b>Total (Incl)</b>	<b>1,998.87</b>

Received by .....

Date .....

Signed .....



Hereby I certify that / Hiermee sertifiseer ek dat  
VOTE / POS NOMMER: .....

(a) Goods / Services identified on this invoice was received,  
Goedse / Diensse geïdentifiseer op hierdie / diensse is ontvang.

(b) As per attached order, all goods and services (if any) issued are allocated to the specified  
budget vote. Goedere en diensse (indien van toepassing) is toegewys op die gespesifiseerde  
begrotingspos op die ooreenstemmende bestel.

(c) All goods and services are available on the budget vote!  
Alle goedere en diensse is beskikbaar op die begrotingspos.

Evendings / diensse wat nie beskikbaar is op die begrotingspos,  
Uitsendinge / diensse wat nie beskikbaar is op die begrotingspos, moet as 'n aparte rekening  
Uitsendinge / diensse wat nie beskikbaar is op die begrotingspos, moet as 'n aparte rekening  
Uitsendinge / diensse wat nie beskikbaar is op die begrotingspos, moet as 'n aparte rekening

*Paulou*  
20/3/2020

MANAGEMENT INCHARGE / VERANTWORDELIJKE BEHEERDER  
MANAGEMENT INCHARGE / VERANTWORDELIJKE BEHEERDER  
MANAGEMENT INCHARGE / VERANTWORDELIJKE BEHEERDER



## Tax Invoice

**SIYAYA TYRES**  
135-139 Commercial Road  
Sidwell  
Port Elizabeth

Tax Registration **4710176308**  
Telephone **041 - 453 2198**  
Fax **041 - 451 2678**

To:  
**STELLMUN001**  
**Stellenbosch Munisipaliteit**  
P O Box 17  
Stellenbosch  
7599

Tax Registration **4700102181**

Account	Date	Order No	Delivery Note	Our Reference
STELLMUN001	13/03/2020			INV319

Item Code	Item Description	Quantity	Unit	Price (Ex)	Disc %	Tax	Total (Incl)
CC/OUT	CALL OUT FEE	1.00		396.00		59.40	455.40
FITTED	FITTED / STRIP	1.00		206.18		30.93	237.11
TRAV	TRAVEL COST PER KM	38.00		7.21		41.10	315.08
PUN/TRAC	P/REPAIRS TRAC Rear 24' to 38'	1.00		253.74		38.06	291.80

DONE BY SAFETY GRIP  
KLAPMUTS  
CL 81470  
POS 1  
28/12/19

Total (Excl)	1,129.90
Tax	169.49
<b>Total</b>	<b>1,299.39</b>
Discount	0.00
<b>Total (Incl)</b>	<b>1,299.39</b>

Received by .....

Date .....

Signed .....



Hereby I certify that / Hiermee sertifiseer ek dat  
VOTE / POS NOLMERS:

(a) Goods / Services listed on this invoice was received.  
Goedere / Dienste gelyktydig op hierdie faktuur is ontvang.

(b) As per attached copy of goods and services delivered are allocated to the specified budget vote. Goedere en dienste gelyktydig is toegewys op die gespesifiseerde begrotingsstemme en versprei beskikbaar.

(c) Adequate funds available on the credit note /  
Wettigende fondse beskikbaar op die betaalnota.  
Expenditure incurred in accordance with Council's SCM policy /  
Uitgawe aanvaar in ooreenstemming met die Raad se G&S beleid.

HEADING: 2015/2020

# Tax Invoice

**SIYAYA TYRES**  
 135-139 Commercial Road  
 Sidwell  
 Port Elizabeth

Tax Registration **4710176308**  
 Telephone **041 - 453 2198**  
 Fax **041 - 451 2678**

To:  
**STELLMUN001**  
**Stellenbosch Munisipaliteit**  
 P O Box 17  
 Stellenbosch  
 7599

Tax Registration **4700102181**

Account	Date	Order No	Delivery Note	Our Reference
STELLMUN001	13/03/2020			INV320

Item Code	Item Description	Quantity	Unit	Price (Ex)	Disc %	Tax	Total (Incl)
CC/OUT	CALL OUT FEE	1.00		396.00		59.40	455.40
FITTED	FITTED / STRIP	1.00		253.50		38.03	291.53

DONE BY SAFETY GRIP  
 KLAPMUTS  
 27/12/19  
 CL 22049  
 POS 1

Total (Excl)	649.50
Tax	97.43
<b>Total</b>	<b>746.93</b>
Discount	0.00
<b>Total (Incl)</b>	<b>746.90</b>

Received by \_\_\_\_\_

Date \_\_\_\_\_

Signed \_\_\_\_\_



Hereby I certify that / Hiermee sertifiseer ek dat  
**VOTE / POE NOMMERS**

(a) Goods / Services identified on this invoice was received.  
 Goedere / Diens gelewer op hierdie faktuur is ontvang.

(b) All per attached order, bill of material and so on above referred are allocated to the specified  
 buigsel volke, Bestelre of, diensre of, diensre of, diensre op die gespesifiseerde  
 bestelre.

(c) All goods / services identified on this invoice were /  
 volke was gelewer op hierdie faktuur.

Expenditure incurred in connection with the above referred to is /  
 Uitgawe wat in verband met die hierboven genoemde is / word op SOU's betaal.

*Rulow*  
 21/3/2020

# Tax Invoice

**SIYAYA TYRES**  
 135-139 Commercial Road  
 Sidwell  
 Port Elizabeth

Tax Registration **4710176308**  
 Telephone **041 - 453 2198**  
 Fax **041 - 451 2678**

**To:**  
**STELLMUN001**  
**Stellenbosch Munisipaliteit**  
 P O Box 17  
 Stellenbosch  
 7599

Tax Registration **4700102181**

Account	Date	Order No	Delivery Note	Our Reference
STELLMUN001	13/03/2020			INV322

Item Code	Item Description	Quantity	Unit	Price (Ex)	Disc %	Tax	Total (Incl)
CC/OUT	CALL OUT FEE	1.00		515.48		77.32	592.80
FITTED	FITTED / STRIP	2.00		206.18		61.85	474.21
PUN/TRAC	P/REPAIRS TRAC Rear 24' to 38'	2.00		257.65		77.30	592.60
STEEL VALVE	STEEL VALVE	1.00		154.66		23.20	177.86
TRAV	TRAVEL COST PER KM	40.00		7.22		43.32	332.12

DONE BY SAFETY GRIP  
 KLAPMUTS  
 4/1/20  
 CL 22049  
 POS 3 EN 4

Total (Excl)	1,886.60
Tax	282.99
<b>Total</b>	<b>2,169.59</b>
Discount	0.00
<b>Total (Incl)</b>	<b>2,169.59</b>

Received by \_\_\_\_\_  
 Date \_\_\_\_\_  
 Signed \_\_\_\_\_



Handwritten signature: *Peter*  
 Date: *20/3/2020*

Stamp: VOTE / POS NOV 1997  
 (a) Goeie / Goeie identifiseer op die faktuur wat ontvang.  
 Goeie / Goeie identifiseer wat kind: faktuur is uitgereik.  
 (b) As per etablisering, faktuur moet word gebruik en oorgedra tot die spesifieke  
 buro / afdeling, Goeie as 'n faktuur kan nie in die gelyke op die gelyke  
 boeke / gelyke as op die faktuur / faktuur.  
 (c) Faktuur moet gebruik word op die faktuur / faktuur.  
 Verduidelik die faktuur op die faktuur / faktuur.  
 Uitgewe as 'n faktuur / faktuur op die faktuur / faktuur.

# Tax Invoice

**SIYAYA TYRES**  
 135-139 Commercial Road  
 Sidwell  
 Port Elizabeth

To:  
**STELLMUN001**  
**Stellenbosch Munisipaliteit**  
 P O Box 17  
 Stellenbosch  
 7599

Tax Registration **4710176308**  
 Telephone **041 - 453 2198**  
 Fax **041 - 451 2678**

Tax Registration **4700102181**

Account	Date	Order No	Delivery Note	Our Reference
STELLMUN001	13/03/2020			INV323

Item Code	Item Description	Quantity	Unit	Price (Ex)	Disc %	Tax	Total (Incl)
CC/OUT	CALL OUT FEE	1.00		391.63		58.74	450.37
FITTED	FITTED / STRIP	2.00		206.18		61.85	474.21
PUN/TRAC	P/REPAIRS TRAC Rear 24' to 38'	2.00		257.73		77.32	592.78
TRAV	TRAVEL COST PER KM	39.00		7.22		42.24	323.82

DONE BY SAFETY GRIP  
 KLAPMUTS  
 CL 81470 EN CL 22049  
 POS 1 EN 2  
 24/12/19

Total (Excl)	1,601.03
Tax	240.15
<b>Total</b>	<b>1,841.18</b>
Discount	0.00
<b>Total (Incl)</b>	<b>1,841.18</b>

Received by \_\_\_\_\_  
 Date \_\_\_\_\_  
 Signed \_\_\_\_\_



Hereby I certify that / Hiermee sertifiseer ek dat  
**VOTE / POS NOUMBER:** \_\_\_\_\_

(a) Goods / Services included on this invoice was received.  
 Goedere / Dienske gelewer is op die spesifieke datum en tydsyde.  
 (b) As per attached invoice all goods and services included are allocated to the specific  
 budget vote. Coördinerende Beampte is aangewys op die goedgekeurde  
 begrotingskode op die inkooporder. (c) Reparaasie is gemaak op die goedgekeurde  
 Veldnommer. Reparaasie is gemaak op die goedgekeurde  
 Ervordingsnommer. Reparaasie is gemaak op die goedgekeurde  
 Dit is gemaak op die goedgekeurde

*Reelou*  
 24/12/2020

# Tax Invoice

**SIYAYA TYRES**  
 135-139 Commercial Road  
 Sidwell  
 Port Elizabeth

Tax Registration **4710176308**  
 Telephone **041 - 453 2198**  
 Fax **041 - 451 2678**

**To:**  
**STELLMUN001**  
**Stellenbosch Munisipaliteit**  
 P O Box 17  
 Stellenbosch  
 7599

Tax Registration **4700102181**

Account	Date	Order No	Delivery Note	Our Reference
STELLMUN001	13/03/2020			INV324

Item Code	Item Description	Quantity	Unit	Price (Ex)	Disc %	Tax	Total (Incl)
CC/OUT	CALL OUT FEE	1.00		515.29		77.29	592.58
FITTED	FITTED / STRIP	1.00		257.73		38.66	296.39
PUN/TRAC	P/REPAIRS TRAC Rear 24' to 38'	1.00		257.73		38.66	296.39
TRAV	TRAVEL COST PER KM	50.00		7.22		54.15	415.15

DONE BY SAFETY GRIP  
 CL 81470  
 17/12/19  
 POS 2  
 KLAPMUTS

Total (Excl)	1,391.75
Tax	208.76
<b>Total</b>	<b>1,600.51</b>
Discount	0.00
<b>Total (Incl)</b>	<b>1,600.51</b>

Received by \_\_\_\_\_  
 Date \_\_\_\_\_  
 Signed \_\_\_\_\_

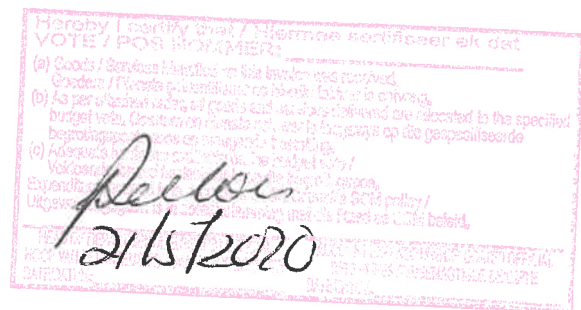
## Tax Invoice

**SIYAYA TYRES**  
135-139 Commercial Road  
Sidwell  
Port Elizabeth

Tax Registration **4710176308**  
Telephone **041 - 453 2198**  
Fax **041 - 451 2678**

Tax Registration **4700102181**

To:  
**STELLMUN001**  
**Stellenbosch Munisipaliteit**  
P O Box 17  
Stellenbosch  
7599

Account	Date	Order No	Delivery Note	Our Reference
STELLMUN001	13/03/2020			INV325

Item Code	Item Description	Quantity	Unit	Price (Ex)	Disc %	Tax	Total (Incl)
CC/OUT	CALL OUT FEE	1.00		393.00		58.95	451.95
FITTED	FITTED / STRIP	2.00		257.04		77.11	591.19
TRAV	TRAVEL COST PER KM	34.00		7.22		36.82	282.30

DONE BY SAFETY GRIP  
KLAPMUTS  
CL 81470  
POS1 EN 2  
2/1/20

Total (Excl)	1,152.56
Tax	172.88
<b>Total</b>	<b>1,325.44</b>
Discount	0.00
<b>Total (Incl)</b>	<b>1,325.44</b>

Received by \_\_\_\_\_

Date \_\_\_\_\_

Signed \_\_\_\_\_



Hereby I certify that / Hiermee sertifiseer ek dat  
VOTE / POJ NOLMNER:

(a) Goods / Services Identified on this invoice was received.  
Goedere / Dienske geïdentifiseer is / isse ontvang.

(b) As per attached / Volgens die aangehegte dokumente is die spesifieke  
budget wils, Krediet en / of ander dokumente op die goewernte  
begrotingswils verskaf.

(c) Additional / Bykomende dokumente /  
Wetenskaplike / Wetenskaplike / Wetenskaplike /  
Eksplisiet / Eksplisiet / Eksplisiet /  
Uiters / Uiters / Uiters /

*Perla*  
21/3/2020

# Tax Invoice

**SIYAYA TYRES**  
 135-139 Commercial Road  
 Sidwell  
 Port Elizabeth

Tax Registration **4710176308**  
 Telephone **041 - 453 2198**  
 Fax **041 - 451 2678**

Tax Registration **4700102181**

To:  
**STELLMUN001**  
**Stellenbosch Munisipaliteit**  
 P O Box 17  
 Stellenbosch  
 7599

Account	Date	Order No	Delivery Note	Our Reference
STELLMUN001	13/03/2020			INV326

Item Code	Item Description	Quantity	Unit	Price (Ex)	Disc %	Tax	Total (Incl)
CC/OUT	CALL OUT FEE	1.00		393.17		58.98	452.15
FITTED	FITTED / STRIP	1.00		257.00		38.55	295.55
PUN/TRAC	P/REPAIRS TRAC Rear 24' to 38'	1.00		257.00		38.55	295.55
TRAV	TRAVEL COST PER KM	12.00		7.22		13.00	99.64

DONE BY SAFETY GRIP  
 KLAPMUTS  
 CL 22049  
 27/12/19  
 POS 2

Total (Excl)	993.81
Tax	149.08
<b>Total</b>	<b>1,142.89</b>
Discount	0.00
<b>Total (Incl)</b>	<b>1,142.89</b>

Received by \_\_\_\_\_  
 Date \_\_\_\_\_  
 Signed \_\_\_\_\_

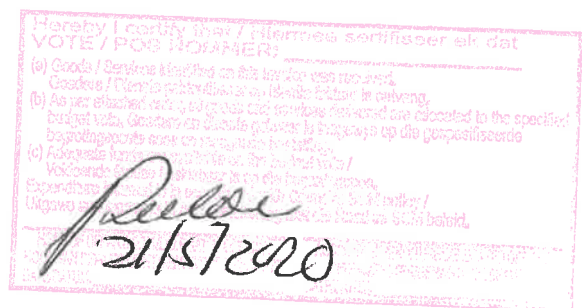
# Tax Invoice

**SIYAYA TYRES**  
 135-139 Commercial Road  
 Sidwell  
 Port Elizabeth

**To:**  
**STELLMUN001**  
**Stellenbosch Munisipaliteit**  
 P O Box 17  
 Stellenbosch  
 7599

Tax Registration **4710176308**  
 Telephone **041 - 453 2198**  
 Fax **041 - 451 2678**

Tax Registration **4700102181**

Account	Date	Order No	Delivery Note	Our Reference
STELLMUN001	13/03/2020			INV327

Item Code	Item Description	Quantity	Unit	Price (Ex)	Disc %	Tax	Total (Incl)
CC/OUT	CALL OUT FEE	1.00		396.00		59.40	455.40
PUN/TRAC	P/REPAIRS TRAC Rear 24' to 38'	1.00		253.50		38.03	291.53
DONE BY SAFETYGRIP KLAPMUTS CL 22049 2/1/20 POS 1							

Total (Excl)	649.50
Tax	97.43
<b>Total</b>	<b>746.93</b>
Discount	0.00
<b>Total (Incl)</b>	<b>746.90</b>

Received by \_\_\_\_\_  
 Date \_\_\_\_\_  
 Signed \_\_\_\_\_



Hereby / party / Hiermee sertifiseer ek dat  
 VOTE / POS NOLANER:  
 (a) Goods / Services identified on the invoice were received.  
 Goedens / Diensens identifiseer ek hierop as ontvang.  
 (b) As per itemised prices, quantities and services indicated are allocated to the specific  
 budget vote. Gedeeltes kan versprei word te wankel op die grappe/waardes  
 te wankel op die grappe/waardes.  
 (c) As goods / services are received on the budget vote /  
 Wankel / Diensens ontvang op die grappe/waardes.  
 Expense / Uitgawe is in ooreenstemming met die SGM policy /  
 Uitgawe is in ooreenstemming met die SGM beleid.

*Reeley*  
 21/3/2020



# Tax Invoice

**SIYAYA TYRES**  
 135-139 Commercial Road  
 Sidwell  
 Port Elizabeth

Tax Registration **4710176308**  
 Telephone **041 - 453 2198**  
 Fax **041 - 451 2678**

**To:**  
**STELLMUN001**  
**Stellenbosch Munisipaliteit**  
 P O Box 17  
 Stellenbosch  
 7599

Tax Registration **4700102181**

Account	Date	Order No	Delivery Note	Our Reference
STELLMUN001	13/03/2020			INV328

Item Code	Item Description	Quantity	Unit	Price (Ex)	Disc %	Tax	Total (Incl)
CC/OUT	CALL OUT FEE	1.00		394.68		59.20	453.88
FITTED	FITTED / STRIP	2.00		257.00		77.10	591.10
PUN/TRAC	P/REPAIRS TRAC Rear 24' to 38'	2.00		257.00		77.10	591.10
DONE BY SAFETY GRIP KLAPMUTS CL 22049 2/1/20 POS 1,2 EN 4							

Total (Excl)	1,422.68
Tax	213.40
<b>Total</b>	<b>1,636.08</b>
Discount	0.00
<b>Total (Incl)</b>	<b>1,636.08</b>

Received by \_\_\_\_\_

Date \_\_\_\_\_

Signed \_\_\_\_\_

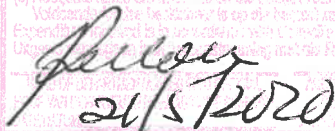

Hierby I certify that / Hiermee sertifiseer ek dat  
 VOTE / POS NOMBERS:  
 (a) Goods / Services listed on this invoice were received.  
 Goedere / Diensle gelewer is op hierdie datum in ontvang.  
 (b) As per attached invoice, all goods and services delivered are allocated to the specified  
 budget vote. Our tax on these services is shown on this gaspedigende  
 besprekingsrekening.  
 (c) Adequate funds are available for the budget vote /  
 Voltoereende fondse is beskikbaar vir die begroting.  
 Expenditure is used in accordance with the relevant financial policy /  
 Uitgawes word gebruik in ooreenstemming met die finansiële beleid.

  
 21/3/2020

# Tax Invoice

**SIYAYA TYRES**  
 135-139 Commercial Road  
 Sidwell  
 Port Elizabeth

**To:**  
**STELLMUN001**  
**Stellenbosch Munisipaliteit**  
 P O Box 17  
 Stellenbosch  
 7599

Tax Registration **4710176308**  
 Telephone **041 - 453 2198**  
 Fax **041 - 451 2678**

Tax Registration **4700102181**

Account	Date	Order No	Delivery Note	Our Reference
STELLMUN001	13/03/2020			INV329

Item Code	Item Description	Quantity	Unit	Price (Ex)	Disc %	Tax	Total (Incl)
CC/OUT	CALL OUT FEE	1.00		393.05		58.96	452.01
FITTED	FITTED / STRIP	1.00		257.00		38.55	295.55
PUN/TRAC	P/REPAIRS TRAC Rear 24' to 38'	1.00		257.00		38.55	295.55
TRAV	TRAVEL COST PER KM	46.00		7.22		49.82	381.94

DONE BY SAFETY GRIP  
 KLAPMUTS  
 CL 22049  
 23/12/19  
 POS 1

Total (Excl)	1,239.17
Tax	185.88
<b>Total</b>	<b>1,425.05</b>
Discount	0.00
<b>Total (Incl)</b>	<b>1,425.05</b>

Received by \_\_\_\_\_

Date \_\_\_\_\_

Signed \_\_\_\_\_



Hereby I certify that / Hiermee sertifiseer ek dat  
 VOTE / POS NOUWERS

(a) Goods / Services listed on this invoice are provided.  
 Goedere / Dienste getydelik op lewerings geleë.

(b) As per attached copy of goods and services invoice, allocated to the specified  
 budget vote. Goedere en dienste is geleë tot toewysing op die gespesifiseerde  
 begrotingsreël as aangevorderde heffings.

(c) Adequate funds are available for the goods and services.  
 Volvoerde fondse is beskikbaar vir goeder en dienste.

Expenditure incurred in respect of the goods and services listed on this invoice /  
 Uitgawe gemaak in verband met die goeder en dienste op hierdie faktuur.

21/3/2020

# Tax Invoice

**SIYAYA TYRES**  
 135-139 Commercial Road  
 Sidwell  
 Port Elizabeth

Tax Registration **4710176308**  
 Telephone **041 - 453 2198**  
 Fax **041 - 451 2678**

**To:**  
**STELLMUN001**  
**Stellenbosch Munisipaliteit**  
 P O Box 17  
 Stellenbosch  
 7599

Tax Registration **4700102181**

Account	Date	Order No	Delivery Note	Our Reference
STELLMUN001	13/03/2020			INV330

Item Code	Item Description	Quantity	Unit	Price (Ex)	Disc %	Tax	Total (Incl)
CC/OUT	CALL OUT FEE	1.00		393.12		58.97	452.09
FITTED	FITTED / STRIP	1.00		257.00		38.55	295.55
PUN/TRAC	P/REPAIRS TRAC Rear 24' to 38'	1.00		257.00		38.55	295.55
TRAV	TRAVEL COST PER KM	28.00		7.22		30.32	232.48

DONE BY SAFETY GRIP  
 KLAPMUTS  
 CL 81470  
 23/12/19  
 POS 2

Total (Excl)	1,109.28
Tax	166.39
<b>Total</b>	<b>1,275.67</b>
Discount	0.00
<b>Total (Incl)</b>	<b>1,275.67</b>

Received by \_\_\_\_\_  
 Date \_\_\_\_\_  
 Signed \_\_\_\_\_

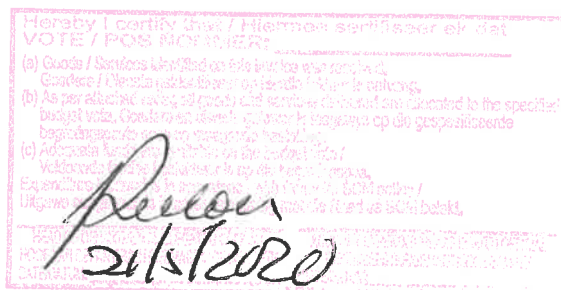
## Tax Invoice

**SIYAYA TYRES**  
135-139 Commercial Road  
Sidwell  
Port Elizabeth

Tax Registration **4710176308**  
Telephone **041 - 453 2198**  
Fax **041 - 451 2678**

Tax Registration **4700102181**

**To:**  
**STELLMUN001**  
**Stellenbosch Munisipaliteit**  
P O Box 17  
Stellenbosch  
7599

Account	Date	Order No	Delivery Note	Our Reference
STELLMUN001	13/03/2020			INV331

Item Code	Item Description	Quantity	Unit	Price (Ex)	Disc %	Tax	Total (Incl)
CC/OUT	CALL OUT FEE	1.00		393.05		58.96	452.01
FITTED	FITTED / STRIP	1.00		257.00		38.55	295.55
PUN/TRAC	P/REPAIRS TRAC Rear 24' to 38'	1.00		257.00		38.55	295.55
TRAV	TRAVEL COST PER KM	50.00		7.22		54.15	415.15

DONE BY SAFETY GRIP  
KLAPMUTS  
CL 22049  
31/12/19  
POS 1

Total (Excl)	1,268.05
Tax	190.21
<b>Total</b>	<b>1,458.26</b>
Discount	0.00
<b>Total (Incl)</b>	<b>1,458.26</b>

Received by .....

Date .....

Signed .....



Hereby I certify that / Hiermee sertifiseer ek dat  
VOTE / POS NOMBERR: .....

(a) Goods / Services identified on this invoice were received.  
Goedere / Diensies geïdentifiseer op hierdie faktuur is ontvang.

(b) As per attached order, all goods and services identified are allocated to the specific  
budget vote. Goedere en diensies geïdentifiseer op die gespesifiseerde  
begrotingspos is toegeken aan die spesifieke faktuur.

(c) Adequate funds are available on the order date.  
Wekwilde fondse is beskikbaar op die faktuur datum.

Expenditure incurred in accordance with Council's SCM policy /  
Uitgawe aanvaar in ooreenstemming met die Raad se BOM beleid.

*Preller*  
26/3/2020

# Tax Invoice

**SIYAYA TYRES**  
 135-139 Commercial Road  
 Sidwell  
 Port Elizabeth

Tax Registration **4710176308**  
 Telephone **041 - 453 2198**  
 Fax **041 - 451 2678**

Tax Registration **4700102181**

To:  
**STELLMUN001**  
**Stellenbosch Munisipaliteit**  
 P O Box 17  
 Stellenbosch  
 7599

Account	Date	Order No	Delivery Note	Our Reference
STELLMUN001	13/03/2020			INV332

Item Code	Item Description	Quantity	Unit	Price (Ex)	Disc %	Tax	Total (Incl)
CC/OUT	CALL OUT FEE	1.00		391.65		58.75	450.40
FITTED	FITTED / STRIP	1.00		206.18		30.93	237.11
PUN/TRAC	P/REPAIRS TRAC Rear 24' to 38'	1.00		206.18		30.93	237.11
TRAV	TRAVEL COST PER KM	28.00		7.22		30.32	232.48

DONE BY SAFETY GRIP  
 KLAPMUTS  
 CL 22049  
 24/12/19  
 POS 3

Total (Excl)	1,006.17
Tax	150.93
<b>Total</b>	<b>1,157.10</b>
Discount	0.00
<b>Total (Incl)</b>	<b>1,157.10</b>

Received by \_\_\_\_\_  
 Date \_\_\_\_\_  
 Signed \_\_\_\_\_



VOTE/POK ROOFERS  
 (a) Goods / Diensle verrigings op die werksaamheid  
 (b) As per order / ooreenkomstige skema / ooreenkomstige skema  
 (c) / ooreenkomstige skema / ooreenkomstige skema  
 24/12/2020

# Tax Invoice

**SIYAYA TYRES**  
 135-139 Commercial Road  
 Sidwell  
 Port Elizabeth

Tax Registration **4710176308**  
 Telephone **041 - 453 2198**  
 Fax **041 - 451 2678**

**To:**  
**STELLMUN001**  
**Stellenbosch Munisipaliteit**  
 P O Box 17  
 Stellenbosch  
 7599

Tax Registration **4700102181**

Account	Date	Order No	Delivery Note	Our Reference
STELLMUN001	16/03/2020			INV333

Item Code	Item Description	Quantity	Unit	Price (Ex)	Disc %	Tax	Total (Incl)
CC/OUT	CALL OUT FEE	1.00		391.75		58.76	450.51
FITTED	FITTED / STRIP	1.00		257.73		38.66	296.39
PUN/TRAC	P/REPAIRS TRAC Rear 24' to 38'	1.00		257.73		38.66	296.39

DONE BY SAFETY GRIP  
 CL 81470  
 14/1/20  
 REGS AGTER BAND  
 KLAPMUTS

Total (Excl)	907.21
Tax	136.08
<b>Total</b>	<b>1,043.29</b>
Discount	0.00
<b>Total (Incl)</b>	<b>1,043.29</b>

Received by \_\_\_\_\_  
 Date \_\_\_\_\_  
 Signed \_\_\_\_\_

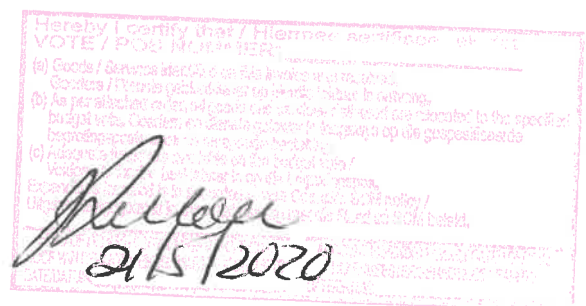
# Tax Invoice

**SIYAYA TYRES**  
 135-139 Commercial Road  
 Sidwell  
 Port Elizabeth

Tax Registration **4710176308**  
 Telephone **041 - 453 2198**  
 Fax **041 - 451 2678**

**To:**  
**STELLMUN001**  
**Stellenbosch Munisipaliteit**  
 P O Box 17  
 Stellenbosch  
 7599

Tax Registration **4700102181**

Account	Date	Order No	Delivery Note	Our Reference
STELLMUN001	16/03/2020			INV334

Item Code	Item Description	Quantity	Unit	Price (Ex)	Disc %	Tax	Total (Incl)
CC/OUT	CALL OUT FEE	1.00		391.75		58.76	450.51
FITTED	FITTED / STRIP	1.00		206.18		30.93	237.11
PUN/TR	P/REPAIRS TRAC Front 16' to 18	1.00		206.19		30.93	237.12

DONE BY BOLAND BANDE  
 CL 81470  
 9/1/20  
 LINKS VOOR  
 STELLENBOSCH DEPO

Total (Excl)	804.12
Tax	120.62
<b>Total</b>	<b>924.74</b>
Discount	0.00
<b>Total (Incl)</b>	<b>924.74</b>

Received by \_\_\_\_\_  
 Date \_\_\_\_\_  
 Signed \_\_\_\_\_



Handwritten signature: *Rein*  
 2015/2020

Stamp: *Evolution (Registered to Oblistax)*

# Tax Invoice

**SIYAYA TYRES**  
 135-139 Commercial Road  
 Sidwell  
 Port Elizabeth

Tax Registration **4710176308**  
 Telephone **041 - 453 2198**  
 Fax **041 - 451 2678**

**To:**  
**STELLMUN001**  
**Stellenbosch Munisipaliteit**  
 P O Box 17  
 Stellenbosch  
 7599

Tax Registration **4700102181**

Account	Date	Order No	Delivery Note	Our Reference
STELLMUN001	16/03/2020			INV335

Item Code	Item Description	Quantity	Unit	Price (Ex)	Disc %	Tax	Total (Incl)
CC/OUT	CALL OUT FEE	1.00		391.75		58.76	450.51
FITTED	FITTED / STRIP	1.00		206.18		30.93	237.11
PUN/TR	P/REPAIRS TRAC Front 16' to 18	1.00		206.19		30.93	237.12

DONE BY BOLAND BANDE  
 CL 81470  
 17/1/20  
 REGS VOOR  
 KLAPMUTS

Total (Excl)	804.12
Tax	120.62
<b>Total</b>	<b>924.74</b>
Discount	0.00
<b>Total (Incl)</b>	<b>924.74</b>

Received by \_\_\_\_\_

Date \_\_\_\_\_

Signed \_\_\_\_\_



Hereby I certify that / Hiermee verklaar ik dat  
 VOTE / POS N-O: 475275

(a) Goods / Services delivered on this invoice are correct.  
 Goedere / Dienste geleverde op hierin afgeleesde.

(b) As per attached note (a) (b) and (c) as shown and indicated in the copy of  
 budget note. Oorspronklike verskepte in die kopie van die begrotingsnota.

(c) Ad equum fieri / In ooreenstemming met die wetgewing.

Wakkerheid van die afgeleesde / In ooreenstemming met die wetgewing.

Ex-entibus / Uit hoofde van die funksie / as aforesaid / Hiermee verklaar ik dat.

16/03/2020



# Tax Invoice

**SIYAYA TYRES**  
 135-139 Commercial Road  
 Sidwell  
 Port Elizabeth

Tax Registration **4710176308**  
 Telephone **041 - 453 2198**  
 Fax **041 - 451 2678**

To:  
**STELLMUN001**  
**Stellenbosch Munisipaliteit**  
 P O Box 17  
 Stellenbosch  
 7599

Tax Registration **4700102181**

Account	Date	Order No	Delivery Note	Our Reference
STELLMUN001	16/03/2020			INV336

Item Code	Item Description	Quantity	Unit	Price (Ex)	Disc %	Tax	Total (Incl)
CC/OUT	CALL OUT FEE	1.00		391.75		58.76	450.51
FITTED	FITTED / STRIP	1.00		206.18		30.93	237.11
PUN/TR	P/REPAIRS TRAC Front 16' to 18	1.00		206.19		30.93	237.12
FITTED	FITTED / STRIP	1.00		257.73		38.66	296.39
PUN/TRAC	P/REPAIRS TRAC Rear 24' to 38'	1.00		257.73		38.66	296.39

DONE BY BOLAND BANDE  
 CL 22049 EN CL 81470  
 KLAPMUTS  
 16/1/20  
 POS 2 EN POS 4

Total (Excl)	1,319.58
Tax	197.94
<b>Total</b>	<b>1,517.52</b>
Discount	0.00
<b>Total (Incl)</b>	<b>1,517.52</b>

Received by \_\_\_\_\_

Date \_\_\_\_\_

Signed \_\_\_\_\_

Hereby I certify that / Hiermee sertifiseer ek dat  
**VOTE / POS N° 118R**

(a) Goods / Services were purchased in accordance with the budget / Die goeie / dienste is gekoop in ooreenspreking met die begroting.

(b) As per attached return, goods with services delivered are allocated to the specified budget code, (Financial Control number), including a copy of the purchase order / Volgens die aangehegte terugkomsel, goeie / dienste is gelever en is toegeken aan die spesifiseerde begroting kode, (Finansiële beheer nommer), insluitende 'n kopie van die aankooporder.

(c) As per attached return, goods with services delivered are allocated to the specified budget code, (Financial Control number), including a copy of the purchase order / Volgens die aangehegte terugkomsel, goeie / dienste is gelever en is toegeken aan die spesifiseerde begroting kode, (Finansiële beheer nommer), insluitende 'n kopie van die aankooporder.

Evans & Partners, Chartered Accountants / E&P, 21/51/2020

# Tax Invoice

**SIYAYA TYRES**  
 135-139 Commercial Road  
 Sidwell  
 Port Elizabeth

Tax Registration **4710176308**  
 Telephone **041 - 453 2198**  
 Fax **041 - 451 2678**

To:  
**STELLMUN001**  
**Stellenbosch Munisipaliteit**  
 P O Box 17  
 Stellenbosch  
 7599

Tax Registration **4700102181**

Account	Date	Order No	Delivery Note	Our Reference
STELLMUN001	16/03/2020			INV337

Item Code	Item Description	Quantity	Unit	Price (Ex)	Disc %	Tax	Total (Incl)
CC/OUT	CALL OUT FEE	1.00		391.75		58.76	450.51
FITTED	FITTED / STRIP	1.00		206.18		30.93	237.11
PUN/TR	P/REPAIRS TRAC Front 16' to 18'	1.00		206.19		30.93	237.12

DONE BY ENRICO  
 CL 22049  
 SLIP 2697  
 KLAPMUTS  
 14/1/20  
 POS 1

Total (Excl)	804.12
Tax	120.62
<b>Total</b>	<b>924.74</b>
Discount	0.00
<b>Total (Incl)</b>	<b>924.74</b>

Received by \_\_\_\_\_  
 Date \_\_\_\_\_  
 Signed \_\_\_\_\_



Hierby I certify that / Hiermee sertifiseer ek dat  
 VOTE / POS NOVEMBER

(a) Goods / Services listed on this invoice were bought  
 Goodere / Diensle geboortelike op die 16de Maart 2020.

(b) As per attached relevant goods and services tax return and allocated to the specific  
 budget vote. Oskere op die 16de Maart 2020 op die goederdiensle  
 boordoprekeerande van die goederdiensle.

(c) All goods / Services listed on this invoice were bought  
 Voltoende diensle geboortelike op die 16de Maart 2020.  
 Spensdure diensle geboortelike op die 16de Maart 2020.

Uitgawe van die 16de Maart 2020.

**21/5/2020**

# Tax Invoice

**SIYAYA TYRES**  
 135-139 Commercial Road  
 Sidwell  
 Port Elizabeth

Tax Registration **4710176308**  
 Telephone **041 - 453 2198**  
 Fax **041 - 451 2678**

**To:**  
**STELLMUN001**  
**Stellenbosch Munisipaliteit**  
 P O Box 17  
 Stellenbosch  
 7599

Tax Registration **4700102181**

Account	Date	Order No	Delivery Note	Our Reference
STELLMUN001	16/03/2020			INV338

Item Code	Item Description	Quantity	Unit	Price (Ex)	Disc %	Tax	Total (Incl)
CC/OUT	CALL OUT FEE	1.00		391.75		58.76	450.51
FITTED	FITTED / STRIP	1.00		206.18		30.93	237.11
PUN/TR	P/REPAIRS TRAC Front 16' to 18	1.00		206.19		30.93	237.12
FITTED	FITTED / STRIP	4.00		257.73		154.64	1,185.56

DONE BY BOLAND BANDE  
 CL 81470 PAPWIEL  
 CL 81470 NA CL 22049 ROTATIONS  
 KLAPMUTS  
 15/1/20

Total (Excl)	1,835.04
Tax	275.26
<b>Total</b>	<b>2,110.30</b>
Discount	0.00
<b>Total (Incl)</b>	<b>2,110.30</b>

Received by \_\_\_\_\_

Date \_\_\_\_\_

Signed \_\_\_\_\_

Hereby I certify that / Hiermee sertifiseer ek dat  
**VOTE / POS NOLMBER:**

(a) Goods / Services identified in this invoice are received.  
 Goedere / Dienste is ontvang.  
 (b) An appropriate amount of goods and services are allocated to the specified budget / Die goedere en dienste is toegevoeg op die gespesifiseerde begroting.  
 (c) All amounts are correct and true.  
 Alle bedrae is korrek en waar.  
 I hereby certify that / Hiermee sertifiseer ek dat

*Priso*  
 21/5/2020



# Tax Invoice

**SIYAYA TYRES**  
 135-139 Commercial Road  
 Sidwell  
 Port Elizabeth

Tax Registration **4710176308**  
 Telephone **041 - 453 2198**  
 Fax **041 - 451 2678**

To:  
**STELLMUN001**  
**Stellenbosch Munisipaliteit**  
 P O Box 17  
 Stellenbosch  
 7599

Tax Registration **4700102181**

Account	Date	Order No	Delivery Note	Our Reference
STELLMUN001	30/03/2020			INV343

Item Code	Item Description	Quantity	Unit	Price (Ex)	Disc %	Tax	Total (Incl)
MRL18/12.5/80ATU482	MRL 12.5/80X18 ATU482	2.00		4550.00		1,365.00	10,465.00
FITTED	FITTED / STRIP	2.00		294.75		88.43	677.93
CC/OUT	CALL OUT FEE	1.00		360.50		54.08	414.58
DONE BY WELLINGTON TYRES 2/1/2020 KLAPMUTS CL 22049 LOASER METER 0284.7							

Received by \_\_\_\_\_  
 Date \_\_\_\_\_  
 Signed \_\_\_\_\_

Total (Excl)	10,050.00
Tax	1,507.51
<b>Total</b>	<b>11,557.51</b>
Discount	0.00
<b>Total (Incl)</b>	<b>11,557.51</b>



Hereby I certify that / Hiermee sertifiseer ek dat  
**VOTE / POE NOMMER:**  
 (a) Goods / Goedere is/are as the invoice was received.  
 Goedere / Goedere is/are as the invoice was received.  
 (b) As per attached and copy attached to the invoice and are allocated to the specified  
 budget vote. Goedere en kopie van die goederlys is/are op die goederlys  
 bevestigingskaart verskied en is/are bevestig.  
 (c) All goods / Goedere is/are as the invoice was received.  
 Goedere en kopie van die goederlys is/are as die goederlys  
 bevestigingskaart verskied en is/are bevestig.  
 Ek verklaar dat / Hiermee verklaar ek dat  
 Hiermee verklaar ek dat / Hiermee verklaar ek dat

*Prifer*  
 21/5/2020

# Tax Invoice

**SIYAYA TYRES**  
 135-139 Commercial Road  
 Sidwell  
 Port Elizabeth

Tax Registration **4710176308**  
 Telephone **041 - 453 2198**  
 Fax **041 - 451 2678**

To:  
**STELLMUN001**  
**Stellenbosch Munisipaliteit**  
 P O Box 17  
 Stellenbosch  
 7599

Tax Registration **4700102181**

Account	Date	Order No	Delivery Note	Our Reference
STELLMUN001	30/03/2020			INV344

Item Code	Item Description	Quantity	Unit	Price (Ex)	Disc %	Tax	Total (Incl)
MRL18/12.5/80ATU482	MRL 12.5/80X18 ATU482	2.00		4550.00		1,365.00	10,465.00
FITTED	FITTED / STRIP	2.00		294.75		88.43	677.93
CC/OUT	CALL OUT FEE	1.00		360.50		54.08	414.58
DONE BY WELLINGTON TYRES KLAPMUTS CL 81470 LOADER METER 2614.2 2/1/2020							

Received by \_\_\_\_\_  
 Date \_\_\_\_\_  
 Signed \_\_\_\_\_

Total (Excl)	10,050.00
Tax	1,507.51
<b>Total</b>	<b>11,557.51</b>
Discount	0.00
<b>Total (Incl)</b>	<b>11,557.51</b>

Herby I certify that / Hiermee sertifiseer ek dat  
 VOTE / POK NOMMER: \_\_\_\_\_

(a) Goods / Goedere waarvan die beskrywing verskaf is.  
 Goedere / Goedere waarvan die beskrywing verskaf is.

(b) As per attached invoice and goods and services received are checked to the supplier's  
 budget book. Oskoppe en goedere ontvang is nagegaan op die goederboek van  
 die verskaffer.

(c) Advertiser / Advertiser se naam en adres is korrek.  
 Advertiser / Advertiser se naam en adres is korrek.

Evans & Partners / Evans & Partners se naam en adres is korrek.  
 Evans & Partners / Evans & Partners se naam en adres is korrek.

21/5/2020

## SIYAYA CORPORATION (PTY) LTD



Reg.No.1972/009281/07 02/01/2020

Creditor no. 012155

Municipality Stellenbosch Quotation CL 22049 Dicker Loader od meter 0284.7

<u>1.</u>	<u>12.5/80/18 HEAVEY DUTY BEAST TYRES</u>	<u>2</u>	<u>9100</u>
<u>2</u>	<u>Call out and labour</u>	<u>2</u>	<u>950</u>
<u>3</u>			
<u>4</u>			
<u>5</u>			
<u>6</u>	<u>Price before vat</u>		<u>10 050 .00</u>
	<u>Vat incl</u>		<u>11 557.50</u>

# SIYAYA CORPORATION (PTY) LTD



Reg.No.1972/009281/07 **work done**

Creditor no. 012155

Municipality Stellenbosch Quotation FQ Specifications.Repair of tyres solid waste management. WORK DONE IN FESTIVE OF SEASON your office close emergency work.NEVILLE and Saliem.

<u>1.</u>	<u>Pod no.34269.34266.34272.33966.33965.33964.34305.</u>		<u>39 504.39</u>
<u>2</u>	<u>Pod no.34309.34267.33980.34259.34303.34276.34265.</u>		
<u>3</u>	<u>Pod no.34264.34273.34262.34263.34270.34308.34307.34274</u>		
<u>4</u>	<u>Pod no.34304.2696.2697.22.24.26.19.20.3396</u>		
<u>5</u>			
<u>6</u>			<u>45 430.05</u>
	<b><u>TOT VAT INCL</u></b>		



# WELLINGTON TYRES

Reg nr: 2016/172707/07

Vat nr: 427260567

Inv. No.	
Job No	34310

## Wellington Tyres - Job Card Books

Transporters Name:	Oliver Tracts	Date:	2/01/2020
Truck Reg No/Fleet No.:	CL 22 049	Speedo Reading:	102847
Front Trailer Reg No.:		Hubodometer Reading Trailer 1:	
Rear Trailer Reg No.:	MST Digger loader	Hubodometer Reading Trailer 2:	
Drivers Name:	Lyamba Umara	Cell No.:	235-3000

### Service Provider Details

Service Provider:	W Tyres	Location of Vehicle:	Hopmans dump
Technician:	Jarett	Cell No:	

↑

1	2
3	X
5	6
7	8
9	10

### Wellington Tyres Details

Kilometers Travelled	-	Call Type Mark with X	Working Hours	After Hours	Sunday / Public Holidays
----------------------	---	--------------------------	---------------	-------------	--------------------------

### Service and Products

Description	Qty.	Description	Qty.
Strip and Fit	2+1	New Rim	
Wheel Rotation		2nd Hand Rim	
Valve Extension		New Tyres	2
Extension Bracket		Retreaded Tyres	
Tubeless Valve		Tubes	
Valve Caps		Flaps	
Puncture Repair	1	Other	

11	12	13	14
15	16	17	18
19	20	21	22
23	24	25	26

SP1

SP2

Tyres Removed  
Mark with X

### Tyre Movements

Whl Pos	Brand / Serial Number	Tyre Size	N/R	Tyre Make	Retread Brand	Design	RTD	Removal Reason (Mark with X)				Scrap Reason
								Smooth Tyre	Maint.	Punct.	Scrap	
ON	0091S/0091	12.5/80-18		MRL		The beast						
OFF	N/A	17.5/80-18		BKT		AT603						old
ON	13725/018	12.5/80-18		MRL		The beast						
OFF	1001/018	12.5/80-18		Retrad								old
ON	N/A	16.9-28.000		OM	50							
OFF												
ON												
OFF												
ON												
OFF												
ON												
OFF												
ON												
OFF												
ON												
OFF												
ON												
OFF												

wheels on site

1	Did The Driver Take The Removed Tyre?	Yes	No	Driver / Fleet Signature:	
2	Have the work been completed?	Yes	No	Driver / Fleet Signature:	
3	Check & Secure Wheelnuts after 100km.	Yes	No	Driver / Fleet Signature:	

# WELLINGTON TYRES

Reg nr: 2016/172707/07

Vat nr: 427260567

Inv. No.	
Job No.	34309

## Wellington Tyres - Job Card Books

Transporters Name: <i>Junior Tracks</i>	Date: <i>2/01/20</i>
Truck Reg No/Fleet No: <i>L22049</i>	Speedo Reading: <i>0584</i>
Front Trailer Reg No. :	Hubodometer Reading Trailer 1:
Rear Trailer Reg No. :	Hubodometer Reading Trailer 2:
Drivers Name: <i>M. Hodas</i>	Cell No. : <i>074 825 416 98</i>

### Service Provider Details

Service Provider: <i>W/TYRES</i>	Location of Vehicle: <i>Repairs dump</i>
Technician: <i>[Signature]</i>	Cell No: <i>013 64 4464</i>

↑

1	2
3	4
5	6
7	8
9	10

### Wellington Tyres Details

Kilometers Travelled	-	Call Type Mark with X	<input checked="" type="checkbox"/> Working Hours	After Hours	Sunday / Public Holidays
----------------------	---	--------------------------	---	-------------	--------------------------

11	12	13	14
15	16	17	18
19	20	21	22
23	24	25	26

### Service and Products

Description	Qty.	Description	Qty.
Strip and Fit /	1	New Rim	
Wheel Rotation		2nd Hand Rim	
Valve Extension		New Tyres.	
Extension Bracket		Retreaded Tyres	
Tubeless Valve		Tubes	
Valve Caps		Flaps	
Puncture Repair	1	Other	

SP1      SP2

**Tyres Removed**  
Mark with X

### Tyre Movements

Whl Pos	Brand / Serial Number	Tyre Size	N/R	Tyre Make	Retread Brand	Design	RTD	Removal Reason (Mark with X)				Scrap Reason
								Smooth Tyre	Maint	Punct	Scrap	
ON	/	<del>225/12</del> 12.5/10-18		Petrol								
OFF		185/80H		Caplow								
ON												
OFF												
ON												
OFF												
ON												
OFF												
ON												
OFF												
ON												
OFF												
ON												
OFF												
ON												
OFF												
ON												
OFF												
ON												
OFF												

1	Did The Driver Take The Removed Tyre?	Yes	No	Driver / Fleet Signature: <i>[Signature]</i>
2	Have the work been completed?	<input checked="" type="checkbox"/> Yes	No	Driver / Fleet Signature:
3	Check & Secure Wheelnuts after 100km.	<input checked="" type="checkbox"/> Yes	No	Driver / Fleet Signature:

# WELLINGTON TYRES

Reg nr: 2016/172707/07

Vat nr: 427260567

Inv. No.	
Job. No.	34267

## Wellington Tyres - Job Card Books

Transporters Name: <i>Luigano's Mania</i>	Date: <i>27/12/19</i>
Truck Reg No/Fleet No.: <i>C22049</i>	Speedo Reading: <i>275.2</i>
Front Trailer Reg No.:	Hubodometer Reading Trailer 1:
Rear Trailer Reg No.:	Hubodometer Reading Trailer 2:
Drivers Name: <i>Luigano's Mania</i>	Cell No.: <i>0835 30 8899</i>

### Service Provider Details

Service Provider: <i>W Tyres</i>	Location of Vehicle: <i>Hubnuts dump</i>
Technician: <i>John</i>	Cell No: <i>065 65 04 39</i>

### Wellington Tyres Details

Kilometers Travelled: <i>6.2</i>	Call Type Mark with X	Working Hours	After Hours	Sunday / Public Holidays
----------------------------------	-----------------------	---------------	-------------	--------------------------

### Service and Products

Description	Qty.	Description	Qty.
Strip and Fit	1	New Rim	
Wheel Rotation		2nd Hand Rim	
Valve Extension		New Tyres	
Extension Bracket		Retreaded Tyres	
Tubeless Valve		Tubes	
Valve Caps		Flaps	
Puncture Repair	1	Other	

1	<del>2</del>
3	4
5	6
7	8
9	10
11	12
13	14
15	16
17	18
19	20
21	22
23	24
25	26

SP1

SP2

**Tyres Removed**  
Mark with X

### Tyre Movements

	Wht Pos	Brand / Serial Number	Tyre Size	N/R	Tyre Make	Retread Brand	Design	RTD	Removal Reason (Mark with X)				Scrap Reason
									Smooth Tyre	Maint.	Punct.	Scrap	
ON	2	<i>C1613</i>	<i>12.5/80</i>	<i>18</i>	<i>BKT</i>	<i>A7603</i>					X		<i>Grass</i>
OFF													<i>GLAS</i>
ON													
OFF													
ON													
OFF													
ON													
OFF													
ON													
OFF													
ON													
OFF													
ON													
OFF													
ON													
OFF													
ON													
OFF													

1	Did The Driver Take The Removed Tyre?	Yes	No	Driver / Fleet Signature:
2	Have the work been completed?	<input checked="" type="checkbox"/> Yes	No	Driver / Fleet Signature:
3	Check & Secure Wheelnuts after 100km	<input checked="" type="checkbox"/> Yes	No	Driver / Fleet Signature:

# WELLINGTON TYRES

Reg nr: 2016/172707/07

Vat nr: 427260567

Inv. No.	WELLINGTON 17/12
Job. No.	34259

## Wellington Tyres - Job Card Books

Transporters Name:	OLIVER FRÖMAS	Date:	17-12-18
Truck Reg No/Fleet No.:	VR MUNICIPALITET	Speedo Reading:	2552
Front Trailer Reg No.:	SEAWAY ROSEN	Hubodometer Reading Trailer 1:	ELB MST 42
Rear Trailer Reg No.:	CL81470	Hubodometer Reading Trailer 2:	LEADER
Drivers Name:	NICOLAS	Cell No.:	0748254698

### Service Provider Details

Service Provider:	W. TYRES	Location of Vehicle:	Klugwatts Dump site
Technician:		Cell No.:	

1	2
3	4
5	6
7	8
9	10
11	12
13	14
15	16
17	18
19	20
21	22
23	24
25	26

### Wellington Tyres Details

Kilometers Travelled	25x2	Call Type Mark with X	Working Hours	<del>After Hours</del>	Sunday / Public Holidays
----------------------	------	--------------------------	---------------	------------------------	-----------------------------

### Service and Products

Description	Qty.	Description	Qty.
Strip and Fit	1	New Rim	
Wheel Rotation		2nd Hand Rim	
Valve Extension		New Tyres	
Extension Bracket		Retreaded Tyres	
Tubeless Valve		Tubes	
Valve Caps		Flaps	
Puncture Repair	1	Other	

SP1      SP2

**Tyres Removed**  
Mark with X

### Tyre Movements

	Whl Pos	Brand / Serial Number	Tyre Size	N/R	Tyre Make	Retread Brand	Design	RTD	Removal Reason (Mark with X)				Scrap Reason
									Smooth Tyre	Maint.	Punct.	Scrap	
ON	Z	03343289	12.5/80-15				MRL					THE BEAST HD	
OFF													
ON													
OFF													
ON													
OFF													
ON													
OFF													
ON													
OFF													
ON													
OFF													
ON													
OFF													
ON													
OFF													
ON													
OFF													

1	Did The Driver Take The Removed Tyre?	Yes	No	Driver / Fleet Signature:	
2	Have the work been completed?	<input checked="" type="radio"/> Yes	No	Driver / Fleet Signature:	
3	Check & Secure Wheelnuts after 100km.	<input checked="" type="radio"/> Yes	No	Driver / Fleet Signature:	

# WELLINGTON TYRES

Reg nr: 2016/172707/07

Vat nr: 427260567

Inv. No.	
Job. No.	34303

## Wellington Tyres - Job Card Books

Transporters Name:	<i>Oliver Tyres</i>	Date:	<i>24/12/2016</i>
Truck Reg No/Fleet No.:	<i>CL 1470</i>	Speedo Reading:	<i>251</i>
Front Trailer Reg No.:	<i>CL 1044</i>	Hubodometer Reading Trailer 1:	<i>1000</i>
Rear Trailer Reg No.:		Hubodometer Reading Trailer 2:	<i>24500</i>
Drivers Name:	<i>Martin</i>	Cell No.:	

### Service Provider Details

Service Provider:	<i>Wellington Tyres</i>	Location of Vehicle:	<i>Oliver Tyres</i>
Technician:	<i>Martin</i>	Cell No.:	<i>076917237</i>

### Wellington Tyres Details

Kilometers Travelled	<i>391</i>	Call Type Mark with X	Working Hours	After Hours	Sunday / Public Holidays
----------------------	------------	--------------------------	---------------	-------------	--------------------------

### Service and Products

Description	Qty.	Description	Qty
Strip and Fit	<i>2 X</i>	New Rim	
Wheel Rotation		2nd Hand Rim	
Valve Extension		New Tyres	
Extension Bracket		Retreaded Tyres	
Tubeless Valve		Tubes	
Valve Caps		Flaps	
Puncture Repair	<i>2 X</i>	Other	

↑

1	2
3	4
5	6
7	8
9	10
11	12
13	14
15	16
17	18
19	20
21	22
23	24
25	26

SP1      SP2

**Tyres Removed**  
Mark with X

### Tyre Movements

	Whl Pos	Brand / Serial Number	Tyre Size	N/R	Tyre Make	Retread Brand	Design	RTD	Removal Reason (Mark with X)				Scrap Reason
									Smooth Tyre	Maint.	Punct.	Scrap	
ON		<i>CL 1470</i>	<i>12.5 R</i>										
OFF			<i>12.5 R</i>										
ON													
OFF													
ON													
OFF													
ON													
OFF													
ON													
OFF													
ON													
OFF													
ON													
FF													
ON													
FF													
ON													

1	Did The Driver Take The Removed Tyre?	<input checked="" type="radio"/> Yes	<input type="radio"/> No	Driver / Fleet Signature:
2	Have the work been completed?	<input checked="" type="radio"/> Yes	<input type="radio"/> No	Driver / Fleet Signature:
3	Check & Secure Wheelnuts after 100km.	<input checked="" type="radio"/> Yes	<input type="radio"/> No	Driver / Fleet Signature:

# WELLINGTON TYRES

Reg nr: 2016/172707/07

Vat nr: 427260567

Inv. No.	
Job. No.	34265

## Wellington Tyres - Job Card Books

Transporters Name:	<i>Sellwood</i>	Date:	<i>27/12/14</i>
Truck Reg No/Fleet No.:	<i>TL 83193</i>	Speedo Reading:	<i>42372</i>
Front Trailer Reg No.:		Hubodometer Reading Trailer 1:	
Rear Trailer Reg No.:		Hubodometer Reading Trailer 2:	
Drivers Name:	<i>HULLP</i>	Cell No.:	<i>05-332-2</i>

### Service Provider Details

Service Provider:	<i>WJ Tyres</i>	Location of Vehicle:	<i>Sellwood</i>
Technician:	<i>Scarlett</i>	Cell No:	<i>065 615 0439</i>

### Wellington Tyres Details

Kilometers Travelled	<i>2012</i>	Call Type Mark with X	<input checked="" type="checkbox"/> Working Hours	After Hours	Sunday / Public Holidays
----------------------	-------------	-----------------------	---	-------------	--------------------------

### Service and Products

Description	Qty.	Description	Qty.
Strip and Fit	<i>1</i>	New Rim	
Wheel Rotation		2nd Hand Rim	
Valve Extension	<i>MAN</i>	New Tyres	
Extension Bracket		Retreaded Tyres	
Tubeless Valve		Tubes	
Valve Caps		Flaps	
Puncture Repair	<i>1</i>	Other	

### Tyre Movements

	Whl Pos	Brand / Serial Number	Tyre Size	N/R	Tyre Make	Retread Brand	Design	RTD	Removal Reason (Mark with X)				Scrap Reason
									Smooth Tyre	Maint.	Punct.	Scrap	
ON		<i>3.697932/314</i>	<i>215</i>		<i>Good New MASTIK</i>						<i>X</i>		<i>2nd Hand Tyres</i>
OFF		<i>OKU75931</i>	<i>215</i>		<i>MAN - 2</i>							<i>X</i>	<i>2nd Hand Tyres</i>
ON													
OFF													
ON													
OFF													
ON													
OFF													
ON													
OFF													
ON													
OFF													
ON													
OFF													
ON													
OFF													
ON													
OFF													



1	2
3	4
5	6
7	8
9	10

11	12	13	14
15	16	17	18
19	20	21	22
23	24	25	26

SP1      SP2

**Tyres Removed**  
Mark with X

1	Did The Driver Take The Removed Tyre?	<input checked="" type="radio"/> Yes	No	Driver / Fleet Signature:
2	Have the work been completed?	<input checked="" type="radio"/> Yes	No	Driver / Fleet Signature:
3	Check & Secure Wheelnuts after 100km	<input checked="" type="radio"/> Yes	No	Driver / Fleet Signature:

# WELLINGTON TYRES

Reg nr: 2016/172707/07

Vat nr: 427260567

Inv. No.	
Job. No.	34264

## Wellington Tyres - Job Card Books

Transporters Name:	Oliver Tractors	Date:	27/12/19
Truck Reg No/Fleet No.:	CL22049	Speedo Reading:	7
Front Trailer Reg No.:		Hubodometer Reading Trailer 1:	
Rear Trailer Reg No.:		Hubodometer Reading Trailer 2:	
Drivers Name:	Kuznetsov Alina	Cell No.:	432 200 199

### Service Provider Details

Service Provider:	W/Tyres	Location of Vehicle:	Highroads dump
Technician:	27XR	Cell No:	

### Wellington Tyres Details

Kilometers Travelled	0	Call Type Mark with X	Working Hours	After Hours	Sunday / Public Holidays
----------------------	---	-----------------------	---------------	-------------	--------------------------

↑

<input checked="" type="checkbox"/>			2
3	4	5	6
7	8	9	10
11	12	13	14
15	16	17	18
19	20	21	22
23	24	25	26

### Service and Products

Description	Qty.	Description	Qty
Strip and Fit	1	New Rim	
Wheel Rotation		2nd Hand Rim	
Valve Extension		new Tyres	4
Extension Bracket		Retreaded Tyres	1
Tubeless Valve		Tubes	
Valve Caps		Flaps	
Puncture Repair		Other	

SP1      SP2

Tyres Removed  
Mark with X

### Tyre Movements

	Whl Pos	Brand / Serial Number	Tyre Size	N/R	Tyre Make	Retread Brand	Design	RTD	Removal Reason (Mark with X)				Scrap Reason
									Smooth Tyre	Maint	Punct.	Scrap	
ON	1	106R-000 734	275/80		Mich		EOS-5						2nd hand Tyre
OFF		NSN			11							X	From Old
ON													
OFF													
ON													
OFF													
ON													
OFF													
ON													
OFF													
ON													
OFF													
ON													
OFF													
ON													
OFF													
ON													
OFF													

1	Did The Driver Take The Removed Tyre?	<input checked="" type="radio"/> Yes	<input type="radio"/> No	Driver / Fleet Signature: _____
2	Have the work been completed?	<input checked="" type="radio"/> Yes	<input type="radio"/> No	Driver / Fleet Signature: _____
3	Check & Secure Wheelnuts after 100km.	<input checked="" type="radio"/> Yes	<input type="radio"/> No	Driver / Fleet Signature: _____

# WELLINGTON TYRES

Reg nr: 2016/172707/07

Vat nr: 427260567

Inv. No.	
Job. No.	34273

## Wellington Tyres - Job Card Books

Transporters Name: <i>Five trades</i>	Date: <i>28/11/19</i>
Truck Reg No/Fleet No.: <i>CL8/470</i>	Speedo Reading: <i>25988</i>
Front Trailer Reg No.:	Hubodometer Reading Trailer 1:
Rear Trailer Reg No.:	Hubodometer Reading Trailer 2:
Drivers Name: <i>FRED</i>	Cell No.: <i>0915330314</i>

### Service Provider Details

Service Provider: <i>W/Tyres</i>	Location of Vehicle: <i>Wynards Way</i>
Technician: <i>Scott</i>	Cell No: <i>0616150439</i>

### Wellington Tyres Details

Kilometers Travelled: <i>1982</i>	Call Type Mark with X	Working Hours	After Hours	Sunday / Public Holidays
-----------------------------------	-----------------------	---------------	-------------	--------------------------

### Service and Products

Description	Qty.	Description	Qty.
Strip and Fit	1	New Rim	
Wheel Rotation		2nd Hand Rim	
Valve Extension		New Tyres	
Extension Bracket		Retreaded Tyres	
Tubeless Valve		Tubes	
Valve Caps		Flaps	
Puncture Repair	1	Other	<i>1x100 3x110</i>



1	2		
3	4	5	6
7	8	9	10
11	12	13	14
15	16	17	18
19	20	21	22
23	24	25	26

SP1      SP2

**Tyres Removed**  
Mark with X

### Tyre Movements

	Whl Pos	Brand / Serial Number	Tyre Size	N/R	Tyre Make	Retread Brand	Design	RTD	Removal Reason (Mark with X)				Scrap Reason
									Smooth Tyre	Maint.	Punct.	Scrap	
ON	1	<i>C48002819</i>	<i>175/50R</i>		<i>The Road</i>		<i>MKL</i>				X		
OFF													
ON													
OFF													
ON													
OFF													
ON													
OFF													
ON													
OFF													
ON													
OFF													
ON													
OFF													
ON													
OFF													
ON													
OFF													
ON													
OFF													

*Grators*

1	Did The Driver Take The Removed Tyre?	Yes	No	Driver / Fleet Signature: _____
2	Have the work been completed?	<input checked="" type="radio"/> Yes	No	Driver / Fleet Signature: _____
3	Check & Secure Wheelnuts after 100km.	<input checked="" type="radio"/> Yes	No	Driver / Fleet Signature: _____



# WELLINGTON TYRES

Reg nr: 2016/172707/07

Vat nr: 427260567

Inv. No.	
Job. No.	34262

## Wellington Tyres - Job Card Books

*Oliver Treads (Stellenbosch Minisport)*

Transporters Name:	<i>Oliver Treads (Stellenbosch Minisport)</i>	Date:	<i>26/12/19</i>
Truck Reg No/Fleet No.:	<i>CL 22049</i>	SCB:	<i>CL 22049</i>
Front Trailer Reg No.:	<i>CL 81476</i>	Hubodometer Reading Trailer 1:	
Rear Trailer Reg No.:		Hubodometer Reading Trailer 2:	
Drivers Name:	<i>Michael</i>	Cell No.:	<i>072652-1198</i>

### Service Provider Details

Service Provider:	<i>Wellington T.</i>	Location of Vehicle:	<i>Stellenbosch Minisport</i>
Technician:	<i>Scott</i>	Cell No:	<i>065615 CL39</i>

### Wellington Tyres Details

Kilometers Travelled	<i>2912</i>	Call Type Mark with X	Working Hours	After Hours	Sunday / Public Holidays
----------------------	-------------	-----------------------	---------------	-------------	--------------------------

*8:40 - 11:00*

### Service and Products

Description	Qty.	Description	Qty.
Strip and Fit	<i>11</i>	New Rim	<i>2</i>
Wheel Rotation		2nd Hand Rim	
Valve Extension		New Tyres	
Extension Bracket		Retreaded Tyres	
Tubeless Valve		Tubes	
Valve Caps		Flaps	
Puncture Repair	<i>3H</i>	Other	<i>(2)</i>

### Tyre Movements

	Whl Pos	Brand / Serial Number	Tyre Size	N/R	Tyre Make	Retread Brand	Design	RTD	Removal Reason (Mark with X)				Scrap Reason
									Smooth Tyre	Maint.	Punct.	Scrap	
ON		<i>318CL421135</i>	<i>6.9.28</i>		<i>CEMSO</i>		<i>E-4</i>				X		<i>31/120 patch</i>
OFF		<i>CL 22049</i>											
ON		<i>2.1062-00780</i>	<i>125/130</i>		<i>The Best</i>						X		<i>2 120 patch</i>
OFF		<i>CL 81476</i>	<i>70</i>										
ON													
OFF													
ON													
OFF													
ON													
OFF													
ON													
OFF													
ON													
OFF													
ON													
OFF													

*Tyres left on site. wrong select was yes not*

1	Did The Driver Take The Removed Tyre?	Yes	No	Driver / Fleet Signature:
2	Have the work been completed?	Yes	No	Driver / Fleet Signature:
3	Check & Secure Wheelnuts after 100km.	Yes	No	Driver / Fleet Signature:

1  2

3  4  5  6

7  8  9  10

11  12  13  14

15  16  17  18

19  20  21  22

23  24  25  26

SP1  SP2

Tyres Removed  
Mark with X

# WELLINGTON TYRES

Reg nr: 2016/172707/07

Vat nr: 427260567

Inv. No.	
Job. No.	34263

## Wellington Tyres - Job Card Books *v.r. Musipal*

Transporters Name:	<i>Oliver Tiquids</i>	Date:	<i>27/12/2019</i>
Truck Reg No/Fleet No.:	<i>CL2064 CL8L70</i>	Speedo Reading:	
Front Trailer Reg No.:		Hubodometer Reading Trailer 1:	
Rear Trailer Reg No.:		Hubodometer Reading Trailer 2:	
Drivers Name:	<i>Pauline</i>	Cell No.:	<i>0770 25411</i>

### Service Provider Details

Service Provider:	<i>Wellington Tyres</i>	Location of Vehicle:	<i>Wairarapa</i>
Technician:	<i>Jarett</i>	Cell No.:	<i>065 615 0439</i>

### Wellington Tyres Details

Kilometers Travelled	<i>2712</i>	Call Type Mark with X	<input checked="" type="checkbox"/>	Working Hours	<i>7:40 - 8:50</i>	After Hours	<input type="checkbox"/>	Sunday / Public Holidays	<input type="checkbox"/>
----------------------	-------------	-----------------------	-------------------------------------	---------------	--------------------	-------------	--------------------------	--------------------------	--------------------------

↑

<input type="checkbox"/>	<input type="checkbox"/>	<input type="checkbox"/>	<input type="checkbox"/>
<input type="checkbox"/>	<input type="checkbox"/>	<input type="checkbox"/>	<input type="checkbox"/>
<input type="checkbox"/>	<input type="checkbox"/>	<input type="checkbox"/>	<input type="checkbox"/>

<input type="checkbox"/>	<input type="checkbox"/>	<input type="checkbox"/>	<input type="checkbox"/>
<input type="checkbox"/>	<input type="checkbox"/>	<input type="checkbox"/>	<input type="checkbox"/>
<input type="checkbox"/>	<input type="checkbox"/>	<input type="checkbox"/>	<input type="checkbox"/>
<input type="checkbox"/>	<input type="checkbox"/>	<input type="checkbox"/>	<input type="checkbox"/>

SP1      SP2

**Tyres Removed**  
Mark with X

### Service and Products

Description	Qty.	Description	Qty.
Strip and Fit	<i>1</i>	New Rim	
Wheel Rotation		2nd Hand Rim	
Valve Extension		New Tyres	
Extension Bracket		Retreaded Tyres	
Tubeless Valve		Tubes	
Valve Caps		Flaps	
Puncture Repair	<i>1</i>	Other	

### Tyre Movements

	Whl Pos	Brand / Serial Number	Tyre Size	N/R	Tyre Make	Retread Brand	Design	RTD	Removal Reason (Mark with X)				Scrap Reason
									Smooth Tyre	Maint	Punct	Scrap	
ON	<i>1</i>	<i>03343789</i>	<i>16-9.28</i>		<i>Comso</i>	<i>RL4</i>						<i>PLUG -</i>	
OFF													
ON													
OFF													
ON													
OFF													
ON													
OFF													
ON													
OFF													
ON													
OFF													
ON													
OFF													
ON													
OFF													
ON													
OFF													

1	Did The Driver Take The Removed Tyre?	<input checked="" type="checkbox"/>	Driver / Fleet Signature:	<i>on site</i>
2	Have the work been completed?	<input checked="" type="checkbox"/>	Driver / Fleet Signature:	<i>Pauline</i>
3	Check & Secure Wheelnuts after 100km.	<input checked="" type="checkbox"/>	Driver / Fleet Signature:	

# WELLINGTON TYRES

Reg nr: 2016/172707/07

Vat nr: 427260567

Inv. No.	
Job. No.	34270

## Wellington Tyres - Job Card Books

Transporters Name: <i>Oliver Tractors</i>	Date: <i>28/2/19</i>
Truck Reg No/Fleet No.: <i>CL81470</i>	Speedo Reading:
Front Trailer Reg No.:	Hubodometer Reading Trailer 1:
Rear Trailer Reg No.:	Hubodometer Reading Trailer 2:
Drivers Name:	Cell No.:

### Service Provider Details

Service Provider: <i>Wellington Tyres</i>	Location of Vehicle: <i>Wairarapa dump</i>
Technician: <i>John</i>	Cell No: <i>0656150439</i>

*9:40 - 9:50*

### Wellington Tyres Details

Kilometers Travelled: <i>2712</i>	Call Type Mark with X	Working Hours	After Hours	Sunday / Public Holidays
-----------------------------------	-----------------------	---------------	-------------	--------------------------

↑

1	2
3	4
5	6
7	8
9	10
11	12
13	14
15	16
17	18
19	20
21	22
23	24
25	26

### Service and Products

Description	Qty.	Description	Qty.
Strip and Fit		New Rim	
Wheel Rotation		2nd Hand Rim	
Valve Extension		New Tyres	
Extension Bracket		Retreaded Tyres	
Tubeless Valve		Tubes	
Valve Caps		Flaps	
Puncture Repair	<i>1</i>	Other	

SP1      SP2

**Tyres Removed**  
Mark with X

### Tyre Movements

	Whl Pos	Brand / Serial Number	Tyre Size	N/R	Tyre Make	Retread Brand	Design	RTD	Removal Reason (Mark with X)				Scrap Reason
									Smooth Tyre	Maint	Punct.	Scrap	
ON	1	<i>0660 2814</i>	<i>175R18</i>		<i>The Best</i>		<i>H111487</i>				<i>x</i>		<i>2 ply 2</i>
OFF													
ON													
OFF													
ON													
OFF													
ON													
OFF													
ON													
OFF													
ON													
OFF													
ON													
OFF													
ON													
OFF													
ON													
OFF													

*Digger was locked  
Didn't have  
keys for*

*Wrong Mark  
Tyre on  
Digger*

1	Did The Driver Take The Removed Tyre?	Yes	No	Driver / Fleet Signature:
2	Have the work been completed?	Yes	No	Driver / Fleet Signature:
3	Check & Secure Wheelnuts after 100km	Yes	No	Driver / Fleet Signature:

Inv. No.	
Job. No:	34308

## Wellington Tyres - Job Card Books

Transporters Name:	OLIVER Tracts	Date:	21/1/20
Truck Reg No/Fleet No.:	L 81470	Speedo Reading:	2611.8
Front Trailer Reg No.:	Digger loader	Hubodometer Reading Trailer 1:	
Rear Trailer Reg No.:		Hubodometer Reading Trailer 2:	
Drivers Name:	M. Chilias	Cell No:	0711525449

### Service Provider Details

Service Provider:	W/T Tyres	Location of Vehicle:	Keppons Lane
Technician:	James	Cell No:	

1	2
3	4
5	6
7	8
9	10
11	12
13	14
15	16
17	18
19	20
21	22
23	24
25	26

### Wellington Tyres Details

Kilometers Travelled	27.5x2	Call Type Mark with X	<input checked="" type="checkbox"/> Working Hours	<input type="checkbox"/> After Hours	<input type="checkbox"/> Sunday / Public Holidays
----------------------	--------	--------------------------	---	--------------------------------------	---

### Service and Products

Description	Qty	Description	Qty.
Strip and Fit	1	New Rim	
Wheel Rotation		2nd Hand Rim	
Valve Extension		New Tyres	
Extension Bracket		Retreaded Tyres	
Tubeless Valve		Tubes	
Valve Caps		Flaps	
Puncture Repair	1	Other	

**Tyres Removed**  
Mark with X

### Tyre Movements

	Whl Pos	Brand / Serial Number	Tyre Size	N/R	Tyre Make	Retread Brand	Design	RTD	Removal Reason (Mark with X)				Scrap Reason
									Smooth Tyre	Maint.	Punct.	Scrap	
ON	1	046002818	17.5-80/18		The best								
OFF													
ON													
OFF													
ON													
OFF													
ON													
OFF													
ON													
OFF													
ON													
OFF													
ON													
OFF													
ON													
OFF													
ON													
OFF													

1	Did The Driver Take The Removed Tyre?	<input checked="" type="checkbox"/> Yes	<input type="checkbox"/> No	Driver / Fleet Signature:
2	Have the work been completed?	<input checked="" type="checkbox"/> Yes	<input type="checkbox"/> No	Driver / Fleet Signature:
3	Check & Secure Wheelnuts after 100km.	<input checked="" type="checkbox"/> Yes	<input type="checkbox"/> No	Driver / Fleet Signature:

# WELLINGTON TYRES

Reg nr: 2016/172707/07

Vat nr: 427260567

Inv. No.	
Job. No.	34307

## Wellington Tyres - Job Card Books

Transporters Name:	Diver Tractors	Date:	3/12/19
Truck Reg No/Fleet No.:	CL 811 70	Speedo Reading:	25888
Front Trailer Reg No.:	Digger loader	Hubodometer Reading Trailer 1:	
Rear Trailer Reg No.:		Hubodometer Reading Trailer 2:	
Drivers Name:	M... ..	Cell No.:	11 5251 48

### Service Provider Details

Service Provider:	w/ Tyres	Location of Vehicle:	the primary dump
Technician:		Cell No.:	

### Wellington Tyres Details

Kilometers Travelled		Call Type Mark with X	<input checked="" type="checkbox"/> Working Hours	After Hours	Sunday / Public Holidays
----------------------	--	--------------------------	---	-------------	--------------------------

### Service and Products

Description	Qty.	Description	Qty.
Strip and Fit	1	New Rim	
Wheel Rotation		2nd Hand Rim	
Valve Extension		New Tyres	
Extension Bracket		Retreaded Tyres	
Tubeless Valve		Tubes	
Valve Caps		Flaps	
Puncture Repair	1	Other	

### Tyre Movements

	Whl Pos	Brand / Serial Number	Tyre Size	N/R	Tyre Make	Retread Brand	Design	RTD	Removal Reason (Mark with X)				Scrap Reason
									Smooth Tyre	Maint.	Punct.	Scrap	
ON	1		12.5-80/18				Trabant AU						
OFF							2 GATONS						
ON													
OFF													
ON													
OFF													
ON													
OFF													
ON													
OFF													
ON													
OFF													
ON													
OFF													
ON													
OFF													
ON													
OFF													

1	2
3	4
5	6
7	8
9	10
11	12
13	14
15	16
17	18
19	20
21	22
23	24
25	26

SP1

SP2

**Tyres Removed**  
 Mark with X

1	Did The Driver Take The Removed Tyre?	<input checked="" type="checkbox"/> Yes	<input type="checkbox"/> No	Driver / Fleet Signature:
2	Have the work been completed?	<input checked="" type="checkbox"/> Yes	<input type="checkbox"/> No	Driver / Fleet Signature:
3	Check & Secure Wheelnuts after 100km.	<input checked="" type="checkbox"/> Yes	<input type="checkbox"/> No	Driver / Fleet Signature:

# WELLINGTON TYRES

Reg nr: 2016/172707/07

Vat nr: 427260567

Inv. No.	
Job. No.	34274

## Wellington Tyres - Job Card Books

Transporters Name:	Oliver Tractors	Date:	30/11/19
Truck Reg No/Fleet No.:	CL 22049	Speedo Reading:	290, 8
Front Trailer Reg No.:		Hubodometer Reading Trailer 1:	
Rear Trailer Reg No.:		Hubodometer Reading Trailer 2:	
Drivers Name:	Luyanda Mawa	Cell No.:	0932308899

### Service Provider Details

Service Provider:	W/TYRES	Location of Vehicle:	Keimut's dump
Technician:	Smith	Cell No.:	CBI 615 0434

### Wellington Tyres Details

Kilometers Travelled	27x2	Call Type Mark with X	Working Hours	After Hours	Sunday / Public Holidays
----------------------	------	-----------------------	---------------	-------------	--------------------------

### Service and Products

Description	Qty.	Description	Qty.
Strip and Fit	1	New Rim	
Wheel Rotation		2nd Hand Rim	
Valve Extension		New Tyres	
Extension Bracket		Retreaded Tyres	
Tubeless Valve		Tubes	
Valve Caps		Flaps	
Puncture Repair	1	Other	2x 110 water 4 pl:KF

### Tyre Movements

	Whl Pos	Brand / Serial Number	Tyre Size	N/R	Tyre Make	Retread Brand	Design	RTD	Removal Reason (Mark with X)				Scrap Reason
									Smooth Tyre	Maint.	Punct.	Scrap	
ON	2	CL 618	12.5 R018		SKT		H/603					X	
OFF													
ON	56	Rubbed off	16.9 23		AMSO		P-4					X	
OFF													
ON													
OFF													
ON													
OFF													
ON													
OFF													
ON													
OFF													
ON													
OFF													
ON													
OFF													
ON													
OFF													

Still on digger

SP1      SP2

Tyres Removed  
Mark with X

1	Did The Driver Take The Removed Tyre?	Yes	No	Driver / Fleet Signature:	
2	Have the work been completed?	Yes	No	Driver / Fleet Signature:	
3	Check & Secure Wheelnuts after 100km	Yes	No	Driver / Fleet Signature:	

# WELLINGTON TYRES

Reg nr: 2016/172707/07

Vat nr: 427260567

Inv. No.	
Job. No.	34304

## Wellington Tyres - Job Card Books

Transporters Name:	Oliver Tractors	Date:	31/12/19
Truck Reg No/Fleet No.:	C122049	Speedo Reading:	232.8
Front Trailer Reg No.:	MBT Digger trailer	Hubodometer Reading Trailer 1:	
Rear Trailer Reg No.:		Hubodometer Reading Trailer 2:	
Drivers Name:	Luzinda MORA	Cell No.:	103508879

### Service Provider Details

Service Provider:	W/TYRES	Location of Vehicle:	Kiaporua dump
Technician:	Lucif	Cell No.:	

### Wellington Tyres Details

Kilometers Travelled	272	Call Type Mark with X	(Working Hours)	After Hours	Sunday / Public Holidays
----------------------	-----	--------------------------	-----------------	-------------	--------------------------

### Service and Products

Description	Qty.	Description	Qty.
Strip and Fit	1	New Rim	
Wheel Rotation		2nd Hand Rim	
Valve Extension		New Tyres	
Extension Bracket		Retreaded Tyres	
Tubeless Valve		Tubes	
Valve Caps		Flaps	
Puncture Repair	2	Other	

↑

1	2
3	4
5	6
7	8
9	10
11	12
13	14
15	16
17	18
19	20
21	22
23	24
25	26

SP1      SP2

**Tyres Removed**  
Mark with X

### Tyre Movements

	Whl Pos	Brand / Serial Number	Tyre Size	N/R	Tyre Make	Retread Brand	Design	RTD	Removal Reason (Mark with X)				Scrap Reason
									Smooth Tyre	Maint.	Punct.	Scrap	
ON	1	C461	12.5/80-18		BCT		AT605				X		1x plug
OFF													
ON		lose wheel											
OFF		3118	12.5/80-18		BCT		AT605				X		2x Centers
ON	5	1822424157	16/9-28-11A								X		2x plugs
OFF							Backhoe 2+1				X		
ON		1x 110 Baller											
OFF		1x 110 Baller											
ON		1x plug											
OFF													
ON													
OFF													
ON													
OFF													
ON													
OFF													
ON													
OFF													

1	Did The Driver Take The Removed Tyre?	Yes	No	Driver / Fleet Signature:
2	Have the work been completed?	Yes	No	Driver / Fleet Signature:
3	Check & Secure Wheelnuts after 100km.	Yes	No	Driver / Fleet Signature:

# WELLINGTON TYRES

Reg nr: 2016/172707/07

Vat nr: 427260567

Inv. No.	
Job. No.	34269

## Wellington Tyres - Job Card Books

Transporters Name:	<i>Waver Trails</i>	Date:	<i>28/12/19</i>
Truck Reg No/Fleet No.:	<i>5 CL 81472</i>	Speedo Reading:	
Front Trailer Reg No:	<i>Stellenbosch Thundri</i>	Hubodometer Reading Trailer 1:	
Rear Trailer Reg No.:		Hubodometer Reading Trailer 2:	
Drivers Name:		Cell No.:	

### Service Provider Details

Service Provider:	<i>WV Tyres</i>	Location of Vehicle:	<i>Stellenbosch</i>
Technician:	<i>Joost</i>	Cell No:	<i>065 615 0430</i>

### Wellington Tyres Details

Kilometers Travelled	<i>2712</i>	Call Type Mark with X	<i>Working Hours</i>	After Hours	Sunday / Public Holidays
----------------------	-------------	-----------------------	----------------------	-------------	--------------------------

### Service and Products

Description	Qty.	Description	Qty.
Strip and Fit	<i>1</i>	New Rim	
Wheel Rotation		2nd Hand Rim	
Valve Extension		New Tyres	
Extension Bracket		Retreaded Tyres	
Tubeless Valve		Tubes	
Valve Caps		Flaps	
Puncture Repair	<i>1</i>	Other	<i>X</i>

### Tyre Movements

	Whl Pos	Brand / Serial Number	Tyre Size	N/R	Tyre Make	Retread Brand	Design	RTD	Removal Reason (Mark with X)				Scrap Reason
									Smooth Tyre	Maint.	Punct.	Scrap	
ON	<i>1</i>	<i>2100 2819</i>	<i>175 R18</i>		<i>The Best</i>		<i>AMU 182</i>				<i>X</i>		
OFF		<i>Check All</i>	<i>Wheel</i>		<i>(Box)</i>								
ON													
OFF													
ON													
OFF													
ON													
OFF													
ON													
OFF													
ON													
OFF													
ON													
OFF													
ON													
OFF													
ON													
OFF													

*Keys was N/A for km*

*27 GAITERS*

SP1

SP2

**Tyres Removed**  
Mark with X

1	2
3	4
5	6
7	8
9	10
11	12
13	14
15	16
17	18
19	20
21	22
23	24
25	26

1	Did The Driver Take The Removed Tyre?	Yes	No	Driver / Fleet Signature:
2	Have the work been completed?	<input checked="" type="checkbox"/>	No	Driver / Fleet Signature:
3	Check & Secure Wheelnuts after 100km	<input checked="" type="checkbox"/>	No	Driver / Fleet Signature:



# WELLINGTON TYRES

Reg nr: 2016/172707/07

Vat nr: 427260567

Inv. No.	
Job. No.	34266

## Wellington Tyres - Job Card Books

Transporters Name:	<i>Waverley Travels</i>	Date:	<i>27/09/19</i>
Truck Reg No/Fleet No.:	<i>181170</i>	Speedo Reading:	<i>2091</i>
Front Trailer Reg No.:	<i>20100001 Mawi</i>	Hubodometer Reading Trailer 1:	
Rear Trailer Reg No.:		Hubodometer Reading Trailer 2:	
Drivers Name:	<i>Michael</i>	Cell No.:	<i>021 222 222</i>

### Service Provider Details

Service Provider:	<i>W/TYRES</i>	Location of Vehicle:	<i>Waverleybrug</i>
Technician:		Cell No:	

### Wellington Tyres Details

Kilometers Travelled	<i>15x2</i>	Call Type Mark with X	<input checked="" type="checkbox"/> Working Hours	After Hours	Sunday / Public Holidays
----------------------	-------------	--------------------------	---	-------------	-----------------------------

### Service and Products

Description	Qty.	Description	Qty.
Strip and Fit	<i>1</i>	New Rim	
Wheel Rotation		2nd Hand Rim	
Valve Extension		New Tyres	
Extension Bracket		Retreaded Tyres	
Tubeless Valve		Tubes	
Valve Caps		Flaps	
Puncture Repair	<i>4x 1</i>	Other	

### Tyre Movements

	Whl Pos	Brand / Serial Number	Tyre Size	N/R	Tyre Make	Retread Brand	Design	RTD	Removal Reason (Mark with X)				Scrap Reason
									Smooth Tyre	Maint.	Punct.	Scrap	
ON		<i>5/6 4540 04 211</i>	<i>6.7-13</i>		<i>Continental</i>		<i>R-4</i>				<input checked="" type="checkbox"/>		
OFF													
ON													
OFF													
ON													
OFF													
ON													
OFF													
ON													
OFF													
ON													
OFF													
ON													
OFF													
ON													
OFF													
ON													
OFF													



1	2
3	4
5	6
7	8
9	10

11	12
13	14
15	16
17	18
19	20
21	22
23	24
25	26

SP1                      SP2

**Tyres Removed**  
Mark with X

1	Did The Driver Take The Removed Tyre?	Yes	No	Driver / Fleet Signature:
2	Have the work been completed?	<input checked="" type="checkbox"/> Yes	No	Driver / Fleet Signature: <i>[Signature]</i>
3	Check & Secure Wheelnuts after 100km	Yes	No	Driver / Fleet Signature:

# WELLINGTON TYRES

Reg nr: 2016/172707/07

Vat nr: 427260567

Inv. No.	
Job. No.	34272

## Wellington Tyres - Job Card Books

Transporters Name:	<i>Auto Services</i>	Date:	<i>28/11/2014</i>
Truck Reg No/Fleet No.:	<i>C122019</i>	Speedo Reading:	<i>2788</i>
Front Trailer Reg No.:		Hubodometer Reading Trailer 1:	
Rear Trailer Reg No.:		Hubodometer Reading Trailer 2:	
Drivers Name:	<i>Marynda Manda</i>	Cell No.:	

### Service Provider Details

Service Provider:	<i>Auto Services</i>	Location of Vehicle:	<i>Waiwera Road</i>
Technician:	<i>[Signature]</i>	Cell No.:	<i>065 615 0439</i>

↑

1	2
3	4
5	6
7	8
9	10

### Wellington Tyres Details

Kilometers Travelled	<i>270</i>	Call Type Mark with X	Working Hours	After Hours	Sunday / Public Holidays
----------------------	------------	-----------------------	---------------	-------------	--------------------------

### Service and Products

Description	Qty.	Description	Qty.
Strip and Fit	1	New Rim	
Wheel Rotation		2nd Hand Rim	
Valve Extension		New Tyres	
Extension Bracket		Retreaded Tyres	
Tubeless Valve		Tubes	
Valve Caps		Flaps	
Puncture Repair	<i>1</i>	Other	

11	12	13	14
15	16	17	18
19	20	21	22
23	24	25	26

SP1      SP2

**Tyres Removed**  
Mark with X

### Tyre Movements

	Whl Pos	Brand / Serial Number	Tyre Size	N/R	Tyre Make	Retread Brand	Design	RTD	Removal Reason (Mark with X)				Scrap Reason
									Smooth Tyre	Maint.	Punct.	Scrap	
ON	<i>DL</i>	<i>C 116 16</i>	<i>DP 80/16</i>		<i>BT</i>		<i>AT 605</i>				<i>X</i>		<i>3 punctures</i>
OFF													
ON													
OFF													
ON													
OFF													
ON													
OFF													
ON													
OFF													
ON													
OFF													
ON													
OFF													
ON													
OFF													
ON													
OFF													

*for still on 0800*

1	Did The Driver Take The Removed Tyre?	Yes	<input checked="" type="checkbox"/> No	Driver / Fleet Signature:
2	Have the work been completed?	<input checked="" type="checkbox"/> Yes	No	Driver / Fleet Signature:
3	Check & Secure Wheelnuts after 100km.	<input checked="" type="checkbox"/> Yes	No	Driver / Fleet Signature:

LNVB54044

# WELLINGTON TYRES

Ref: 2016/172707/07

Vat nr: 427260567

## Wellington Tyres - Job Card Books

Inv. No.	
Job. No.	33966

Transporters Name:	DEWELL TYPING & PRINTING	Date:	23.12.2019
Truck Reg No/Fleet No.:	CL 81470	Speedo Reading:	2586
Front Trailer Reg No.:	2016/172707	Hubodometer Reading Trailer 1:	
Rear Trailer Reg No.:		Hubodometer Reading Trailer 2:	
Drivers Name:	NICOLAS	Cell No.:	

### Service Provider Details

Service Provider:	W/TOP TYRES	Location of Vehicle:	KLAPMETS
Technician:	GABRIEL SPOLZE	Cell No.:	

### Wellington Tyres Details

Kilometers Travelled	14X2	Call Type Mark with X	Working Hours	After Hours	Sunday / Public Holidays
----------------------	------	--------------------------	---------------	-------------	--------------------------

### Service and Products

Description	Qty.	Description	Qty.
Strip and Fit	1	New Rim	
Wheel Rotation		2nd Hand Rim	
Valve Extension		New Tyres	
Extension Bracket		Retreaded Tyres	
Tubeless Valve		Tubes	
Valve Caps		Flaps	
Puncture Repair	X 1	Other	2 CAITOK

### Tyre Movements

	Whl Pos	Brand / Serial Number	Tyre Size	N/R	Tyre Make	Retread Brand	Design	RTD	Removal Reason (Mark with X)				Scrap Reason
									Smooth Tyre	Maint.	Punct.	Scrap	
ON		106R-002220	12.5/20-18		M BERT	N	MILL				X		
OFF													
ON													
OFF													
ON													
OFF													
ON													
OFF													
ON													
OFF													
ON													
OFF													
ON													
OFF													
ON													
OFF													
ON													
OFF													

1	Did The Driver Take The Removed Tyre?	Yes	No	Driver / Fleet Signature:
2	Have the work been completed?	Yes	No	Driver / Fleet Signature:
3	Check & Secure Wheelnuts after 100km.	Yes	No	Driver / Fleet Signature:

↑

1			
3	4	5	6
7	8	9	10
11	12	13	14
15	16	17	18
19	20	21	22
23	24	25	26

SP1      SP2

**Tyres Removed**  
Mark with X

# WELLINGTON TYRES

DIV 58954

2016/172707/07

Vat nr: 427260567

Inv. No.	
Job. No.	33965

## Wellington Tyres - Job Card Books MUNICIPALITY

Transporters Name:	WISSE THOMAS B	Date:	24.12.2019
Truck Reg No/Fleet No.:	CC 72049	Speedo Reading:	1120
Front Trailer Reg No.:	solid waste	Hubodometer Reading Trailer 1:	
Rear Trailer Reg No.:		Hubodometer Reading Trailer 2:	
Drivers Name:	NICOLAS	Cell No.:	

### Service Provider Details

Service Provider:	WELLINGTON TYRES	Location of Vehicle:	KRAPMUTS
Technician:	GERTH/STOLZE	Cell No.:	

### Wellington Tyres Details

Kilometers Travelled	112	Call Type Mark with X	Working Hours	After Hours	Sunday / Public Holidays
----------------------	-----	-----------------------	---------------	-------------	--------------------------

### Service and Products

Description	Qty.	Description	Qty.
Strip and Fit	1	New Rim	
Wheel Rotation		2nd Hand Rim	
Valve Extension		New Tyres	
Extension Bracket		Retreaded Tyres	
Tubeless Valve		Tubes	
Valve Caps		Flags	
Puncture Repair	1	Other XL GAULTOR	2

### Tyre Movements

Whl Pos	Brand / Serial Number	Tyre Size	N/R	Tyre Make	Retread Brand	Design	RTD	Removal Reason (Mark with X)				Scrap Reason
								Smooth Tyre	Maint.	Punct.	Scrap	
ON	169-28-2316	M	SARHE	M	NM				X			
OFF												
ON												
OFF												
ON												
OFF												
ON												
OFF												
ON												
OFF												
ON												
OFF												
ON												
OFF												
ON												
OFF												
ON												
OFF												

1	Did The Driver Take The Removed Tyre?	<input checked="" type="checkbox"/> Yes	<input type="checkbox"/> No	Driver / Fleet Signature:
2	Have the work been completed?	<input checked="" type="checkbox"/> Yes	<input type="checkbox"/> No	Driver / Fleet Signature:
3	Check & Secure Wheelnuts after 100km.	<input checked="" type="checkbox"/> Yes	<input type="checkbox"/> No	Driver / Fleet Signature:



1	2
<input checked="" type="checkbox"/> 3	4
5	6
7	8
9	10
11	12
13	14
15	16
17	18
19	20
21	22
23	24
25	26

SP1

SP2

**Tyres Removed**  
 Mark with X

INV58953

# WELLINGTON TYRES

Reg nr: 2016/72707107

Vat nr: 427260567

Inv. No.	
Job. No.	33964

## Wellington Tyres - Job Card Books

Transporters Name:	Actual work site	Date:	23-12-2019
Truck Reg No/Fleet No.:	CL 27049	Speedo Reading:	268
Front Trailer Reg No.:		Hubodometer Reading Trailer 1:	
Rear Trailer Reg No.:		Hubodometer Reading Trailer 2:	
Drivers Name:	PICOLAS	Cell No.:	

### Service Provider Details

Service Provider:	LAETAH/SPALITE	Location of Vehicle:	KLAPMATS
Technician:	W/TOP TYRES	Cell No:	

### Wellington Tyres Details

Kilometers Travelled	23x2	Call Type Mark with X	Working hours	After Hours	Sunday / Public Holidays
----------------------	------	-----------------------	---------------	-------------	--------------------------

### Service and Products

Description	Qty.	Description	Qty.
Strip and Fit	1	New Rim	
Wheel Rotation		2nd Hand Rim	
Valve Extension		New Tyres	
Extension Bracket		Retreaded Tyres	
Tubeless Valve		Tubes	
Valve Caps		Flaps	
Puncture Repair	1	Other	X2. LAITORS X2

↑

<input checked="" type="checkbox"/>			2
3	4	5	6
7	8	9	10
11	12	13	14
15	16	17	18
19	20	21	22
23	24	25	26

SP1

SP2

**Tyres Removed**  
Mark with X

### Tyre Movements

	Whl Pos	Brand / Serial Number	Tyre Size	N/R	Tyre Make	Retread Brand	Design	RTD	Removal Reason (Mark with X)				Scrap Reason
									Smooth Tyre	Maint.	Punct.	Scrap	
ON	X	17.5/180-18	0519	R	DETAH	N	JPA-25				X		
OFF													
ON													
OFF													
ON													
OFF													
ON													
OFF													
ON													
OFF													
ON													
OFF													
ON													
OFF													
ON													
OFF													
ON													
OFF													

1	Did The Driver Take The Removed Tyre?	Yes	No	Driver / Fleet Signature:
2	Have the work been completed?	Yes	No	Driver / Fleet Signature:
3	Check & Secure Wheelnuts after 100km.	Yes	No	Driver / Fleet Signature:

# WELLINGTON TYRES

nr: 2016/172707/07

Vat nr: 427260567

Inv. No.	34305
Job. No.	34305

## Wellington Tyres - Job Card Books

Transporters Name:	Oliver Trains	Date:	30/12/19
Truck Reg No/Fleet No.:	<del>230</del> CDOLR	Speedo Reading:	254.7
Front Trailer Reg No.:	Digger bucker	Hubodometer Reading Trailer 1:	
Rear Trailer Reg No.:		Hubodometer Reading Trailer 2:	
Drivers Name:	LUCIANO MANA	Cell No.:	083 530 8899

### Service Provider Details

Service Provider:	WY/SPS	Location of Vehicle:	Halmats
Technician:		Cell No.:	

### Wellington Tyres Details

Kilometers Travelled	50	Call Type Mark with X	Working Hours	After Hours	Sunday / Public Holidays
----------------------	----	--------------------------	---------------	-------------	--------------------------

### Service and Products

Description	Qty.	Description	Qty.
Strip and Fit	1	New Rim	
Wheel Rotation		2nd Hand Rim	
Valve Extension		New Tyres	
Extension Bracket		Retreaded Tyres	
Tubeless Valve		Tubes	
Valve Caps		Flaps	
Puncture Repair		Other	

↑

1	2
3	4
5	6
7	8
9	10

11	12	13	14
15	16	17	18
19	20	21	22
23	24	25	26

SP1

SP2

**Tyres Removed**  
Mark with X

### Tyre Movements

	Whl Pos	Brand / Serial Number	Tyre Size	N/R	Tyre Make	Retread Brand	Design	RTD	Removal Reason (Mark with X)				Scrap Reason
									Smooth Tyre	Maint.	Punct.	Scrap	
ON	1	3118	12.5R17.5		BFT		A7605						
OFF		CL61	12.5R17.5		BFT		A7605					X	Old
ON													
OFF													
ON													
OFF													
ON													
OFF													
ON													
OFF													
ON													
OFF													
ON													
OFF													
ON													
OFF													
ON													
OFF													
ON													
OFF													
ON													
OFF													

1	Did The Driver Take The Removed Tyre?	<input checked="" type="radio"/> Yes	<input type="radio"/> No	Driver / Fleet Signature:	
2	Have the work been completed?	<input checked="" type="radio"/> Yes	<input type="radio"/> No	Driver / Fleet Signature:	
3	Check & Secure Wheelnuts after 100km.	<input checked="" type="radio"/> Yes	<input type="radio"/> No	Driver / Fleet Signature:	



CABERNET STR  
UNITS 5 & 6  
SAXENBURG PARK  
BLACKHEATH

Tel: 021 905 8153  
Fax: 021 905 7365  
E-mail: kobus@oliver.co.za  
Cell: 082 462 5129

Date: 14/01/20 Order No.:  
Customer Name: Skh. B. Municipiteit  
Callout area: Klappers  
Address:  
Truck Km: 26684 Cust. Driver:  
Tel. no: Cell:  
Reg./Fleet No.: 2-814 70

SERVICE DRIVER: Enrico Houty

TIME ARRIVED: 12:21

TIME COMPLETED: 13:08

CASINGS left at Customer

Casings in for job repair

JOB DESCRIPTION TOTAL

Strip & Fit

Puncture Repair - Size

Wheel Rotation

TOTAL

REMARKS:

Strip of 19 Sed hard  
type X1 16,9-28

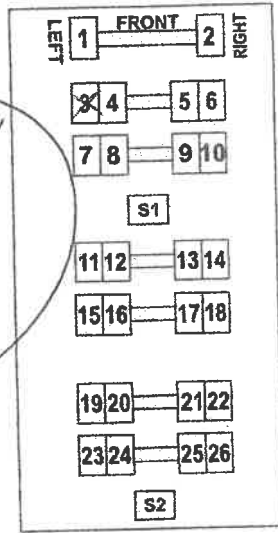

Terms and Conditions: Goods remain the property of OLIVER TREADS CAPE TOWN until fully paid.

CUSTOMER SIGNATURE:

Print Name  
Nicolaas

Signature



CABERNET STR  
UNITS 5 & 6  
SAXENBURG PARK  
BLACKHEATH

Tel: 021 905 8153  
Fax: 021 905 7365  
E-mail: kobus@oliver.co.za  
Cell: 082 462 5129

Date: 14/01/20 Order No.: 2697  
Customer Name: Stett-B. Municipality  
Callout area: Klapanna  
Address: \_\_\_\_\_  
Truck Km: 316,7 Cust, Driver: \_\_\_\_\_  
Tel. no: \_\_\_\_\_ Cell: \_\_\_\_\_  
Reg./Fleet No.: A 22049

SERVICE DRIVER: Carino/Henry  
TIME ARRIVED: 12:40  
TIME COMPLETED: 12:48  
CASINGS left at Customer \_\_\_\_\_  
Casings in for job repair \_\_\_\_\_

JOB DESCRIPTION	TOTAL
Strip & Fit	
Puncture Repair - Size	
Wheel Rotation	
<b>TOTAL</b>	<u>1950</u>

REMARKS:

Repair & check 175/80-18 H/Repair

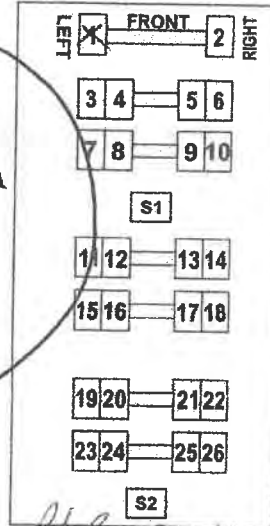

Terms and Conditions: Goods remain the property of OLIVER TREADS CAPE TOWN until fully paid.

CUSTOMER SIGNATURE:

Print Name

Signature

Maryanda Maria

[Signature]



28

Klopnuts "Damp"

15/01/90

CL 21470 Puntues plug x 2

CL 22049

~~Roten~~

Rotations x 4

16.9.98

~~MANA~~

24

Klapmuts Dumping" 16 / 01 / 200

Digger CL 81049  
Plug x 2 voor wiel (R)

Digger CL 81470  
Plug x 2 achter wiel (R)

Michielas

~~XXXXXXXXXX~~

20

Damping

17.01.0090

Digger Louder

CL 81470

Pictures Guitar no: 3

L.M.A.N.A



19

Stephan (Stellenbosch)

09/01/2000

Voor wiel Digger CL 81470 R (Jings)

Gitar x 1 No 3

Moneta?

~~2/2/1/1/1/1/1~~

20

Klapmuts "Damp"

14 / 01 / 2020

Digger loader CL 81470

1:1 x3 Gg. tar no 3 Regs aflee

*Mach...*

~~XXXXXXXXXX~~

CL 81410

Log No/Fleet No	Hubometer Reading Trailer 1	33980
Trailer Reg No	Hubometer Reading Trailer 2	
Trailer Reg No	Call No	

Service Provider Details

Service Provider	Wellington Tyres	Location of Vehicle	KIA PRIVUS
Technician	Marshall Kelly	Call No	

Wellington Tyres Details

Kilometers Traveled	34	Call Type Mark with X	Working Hours	After Hours	Pu
---------------------	----	--------------------------	------------------	----------------	----

Service and Products

Description	Qty	Description
Strip and Fit	2	New Rim
Wheel Rotation		2nd Hand Rim
Valve Extension		New Tyres ZION STR
Extension Bracket		Retreaded Tyres
Tubeless Valve		Tubes
Valve Caps		Flaps
Puncture Repair		Other

Tyre Movements

Pos	Brand / Serial Number	Tyre Size	N/R	Tyre Make	Retread Brand	Design	RTD	Removal Reason (Mark with X)				Scr
								Smooth Tyre	Maint	Punct	Scrap	
	137034019	12.5/80-18		THE BEAST		MRL						
	1416	12.5/80-18		THE BEAST		MEL						
	064314119	12.5/80-18		THE BEAST		MEL						
	1416	12.5/80-18		THE BEAST		MEL						

↑

4	5	6
8	9	10
12	13	14
16	17	18
20	21	22
24	25	26

SP2

Tires Removed  
Mark with X

## SIYAYA CORPORATION (PTY) LTD



Reg.No.1972/009281/07 02/01/2020

Creditor no. 012155

Municipality Stellenbosch Quotation CL 22049 Dicker Loader od meter 0284.7

<u>1.</u>	<u>12.5/80/18 HEAVEY DUTY BEAST TYRES</u>	<u>2</u>	<u>9100</u>
<u>2</u>	<u>Call out and labour</u>	<u>2</u>	<u>950</u>
<u>3</u>			
<u>4</u>			
<u>5</u>			
<u>6</u>	<u>Price before vat</u>		<u>10 050.00</u>
	<u>Vat incl</u>		<u>11 557.50</u>

12.1.3	<b>CONSIDERATION OF EXPENDITURE INCURRED RELATING TO LOCAL PRODUCTION AND CONTENT</b>
--------	---

Collaborator No:

IDP KPA Ref No:

Meeting Date:

Good Governance

05 November 2020 &amp; 25 November 2020

**1. SUBJECT: CONSIDERATION OF EXPENDITURE INCURRED RELATING TO LOCAL PRODUCTION AND CONTENT**

**2. PURPOSE OF REPORT**

To provide information regarding the irregular expenditure incurred relating to local production and content and, to be recommended and considered by Council to certify the expenditure as irrecoverable and to be written off by Council as per the Stellenbosch Municipal Supply Chain Management Policy (2020/2021) embodied from the principles as specified in the Preferential Procurement Regulations of 2017.

**3. DELEGATED AUTHORITY**

Council

**4. EXECUTIVE SUMMARY**

Preferential Procurement Regulations (PPR) 2017, PPR 8(2), requires that, an organ of the state must, in case of a designated sector, advertise the invitation to tender with a specific condition that only locally produced or locally manufactured goods, meeting the stipulated minimum threshold for local production and content, will be considered.

The Auditor-General, in its findings during the 2017/2018 financial year, identified that the Municipality did not include a specific condition that local production and content is applicable when inviting bidders to tender (advertisement). Furthermore the Municipality also did not include the local production and content in the bid documents (MBD 6.2) and the suppliers declared accordingly. The Auditor-General concluded that the tender award does not comply with Preferential Procurement Regulations 2017.

However, the Municipality disagrees with the findings of the Auditor-General, as the PPFA Regulations of 2017 does not stipulate in brackets (advertisement) as alluded in the findings. In order to advertise, the invitation to tender places emphasis on the tender document that need to include the minimum thresholds (MBD6.2) that are advertised as a complete document and from which potential bidders submit bid offers.

Irregular expenditure is defined in the Municipal Finance Management Act (Act 56 of 2003) as expenditure incurred by a municipality or municipal entity in contravention of, or that is not in accordance with, a requirement of the supply chain management policy of the municipality or entity or any of the municipality's by-laws giving effect to such policy, and which has not been condoned in terms of such policy or by-law. Furthermore expenditure incurred means the amounts that were expensed or work done, therefore the MPAC and municipal council can only considered amounts already expensed.

This item did serve before MPAC and was certified as irrecoverable and written-off by the municipal council, but council only considered the expenditure that was incurred up to that specific point. This return item is to consider the expenditure that was incurred subsequent to council's resolution.



---

**5. RECOMMENDATION**

For MPAC consideration

**6. DISCUSSION****Background**

The Auditor-General, in its findings during the 2017/2018 financial year, identified that the Municipality did not include a specific condition that local production and content is applicable when inviting bidders to tender (advertisement). Furthermore the Municipality also did not include the local production and content in the bid documents (MBD 6.2) and the suppliers declared accordingly. The Auditor-General concluded that the tender award does not comply with Preferential Procurement Regulations 2017.

However, the Municipality disagrees with the findings of the Auditor-General, as the PPFA Regulations of 2017 does not stipulate in brackets (advertisement) as alluded in the findings. In order to advertise, the invitation to tender places emphasis on the tender document that need to include the minimum thresholds (MBD6.2) that are advertised as a complete document and from which potential bidders submit bid offers.

The Municipality seeks to encourage socio-economic transformation within the area of Stellenbosch. To achieve this, empowerment goals have been set, which aim to redress the skewed distribution of wealth and therefore contribute to the alleviation of poverty. The Municipality encourages increased usage of local resources, stimulation of skills development and transfer, fast tracking the growth and ensures sustainability of SMME's.

It is further imperative to note that the SCM regulations under public invitation of competitive bids specifically refer to the fact that:

A supply chain management policy must determine the procedure for the invitation of competitive bids, and must stipulate –

“that any invitation to prospective providers to submit bids must be by means of a public advertisement in newspapers commonly circulating locally, the website of the municipality or municipal entity or any other appropriate ways (which may include an advertisement in the Government Tender Bulletin)”.

Confirmation was presented by National Treasury in this regard. No financial loss incurred or any misuse or loss of a public resource or no substantial harms to the public sector or general public resulted due to this omission. Management has followed due processes to ensure that tenders complied with the requirements of the regulations relating to local production and content.

The Municipality has strengthened its internal controls tremendously. The advertisement has been amended to include the full conditions of local content. We have also implemented a control to send the specification/BOQ to the DTI to confirm if local content is applicable to a certain tender if we as a Municipality are unsure / divided. The DTI then confirms if local content should be applied or not. The BSC (who consists of the Directors) reviews the document and verify the local content in the document as well as DTI confirmation where applicable. We are confident that sufficient controls are in place but constantly strive to improve and streamline the process.

The table below depicts the matter raised by the Auditor-General during audit and as a corrective measure, the administration is requesting Council to write off these irregular expenditures with the explanations and recommendation given.

Tender No.	Description	Supplier Name	Total Award	Expenditure
B/SM 095 17	Construction of the Plankenburg main outfall sewer and associated works phase 2 & 3.	CSV Construction-Wezan JV.	R 92 462 923.09	R 43 610 656.28

**BSM 95/17 (Plankenburg main outfall sewer)** – This tender entails the excavation of trenches up to 5 meters deep and the installation of larger diameter sewer pipes. From inspecting the Bill of Quantities it follows that items that was perceived to relate to local content items like cables actually refer to ancillary payment items for construction work close to existing services (like cables). Reference to project specifications was done to confirm this. If there are items of local content nature it would be negligible in comparison to the R77 million award. It would for instance not be a factor for any contractor not to submit a tender. Several bids were indeed received.

Irregular expenditure is defined in the Municipal Finance Management Act (Act 56 of 2003) as expenditure incurred by a municipality or municipal entity in contravention of, or that is not in accordance with, a requirement of the supply chain management policy of the municipality or entity or any of the municipality's by-laws giving effect to such policy, and which has not been condoned in terms of such policy or by-law. Furthermore, expenditure incurred means the amounts that were expensed or work done, therefore the MPAC and municipal council can only considered amounts already expensed.

This item did serve before MPAC and was certified as irrecoverable and written-off by the municipal council, but council only considered the expenditure that was incurred up to that specific point. This return item is to consider the expenditure that was incurred subsequent to council's resolution.

## 7. FINANCIAL IMPLICATIONS

Financial implications relating to irregular expenditure that incurred on the local production and content.

## 8. LEGAL IMPLICATIONS

Supply Chain Management Regulations  
 Preferential Procurement Regulations (PPR) 2017  
 Municipal Management Finance Act

## 9. RISK IMPLICATIONS

Reporting irregular expenditure timeously

## 10. MUNICIPAL MANAGER'S COMMENT

SCM processes around local production and content have been changed to provide for more stringent processes to prevent the re-occurrence. It should be noted that this tender was awarded at the beginning of 2017/18 and all revised processes have been implemented.

**MPAC MEETING: 2020-11-05: ITEM 5.3**

MPAC took note of the circumstances and facts as provided in the report, as well as the input by the Office of the Auditor-General.

**RECOMMENDATIONS FROM MPAC TO COUNCIL: 2020-11-05: ITEM NO. 5.3**

- (a) that Council certifies the irregular expenditure of the second year of the contract to the amount of R 43 610 656, 28 (excluding VAT) as irrecoverable; and
- (b) that Council writes off the irregular expenditure as irrecoverable in terms of the MFMA Section 32(2).

**FOR FURTHER DETAILS CONTACT:**

<b>NAME</b>	Kevin Carolus
<b>POSITION</b>	<i>Chief Financial Officer</i>
<b>DIRECTORATE</b>	<i>Financial Services</i>
<b>CONTACT NUMBERS</b>	<i>021 808 8528</i>
<b>E-MAIL ADDRESS</b>	kevin.carolus@stellenbosch.gov.za
<b>REPORT DATE</b>	<i>22 October 2020</i>

13.	<b>REPORTS BY THE MUNICIPAL MANAGER</b>
13.1	<b>SCHEDULE OF PROPOSED DATES FOR MEETINGS OF COUNCIL, MAYORAL COMMITTEE, STANDING COMMITTEES AND OTHER COMMITTEES OF COUNCIL FOR THE 2021 CALENDAR YEAR</b>

Collaborator No:

IDP KPA Ref No:

Meeting Date:

Good Governance

25 November 2020

**1. SUBJECT: SCHEDULE OF PROPOSED DATES FOR MEETINGS OF COUNCIL, MAYORAL COMMITTEE, STANDING COMMITTEES AND OTHER COMMITTEES OF COUNCIL FOR THE 2021 CALENDAR YEAR**

**2. PURPOSE**

To inform Council of the schedule of proposed dates for meetings of Council, Mayoral Committee, Standing Committees and other Committees of Council for the 2021 calendar year.

**3. DELEGATED AUTHORITY**

The Speaker determines the dates of Municipal Council meetings. Dates for other meetings are determined by the Speaker in consultation with the various chairpersons of the meetings. The Executive Mayor may determine dates for the Mayoral Committee.

**4. EXECUTIVE SUMMARY**

An annual schedule of proposed dates for meetings is compiled in the interest of good governance and proper order. Besides complying with legislated requirements, a schedule of proposed dates of meetings enables councillors to plan their events, engagements and community activities.

Section 19 of the Local Government: Municipal Systems Act, 32 of 2000, stipulates that:

*“The municipal manager of a municipality must give notice to the public, in a manner determined by the municipal council, of the time, date and venue of every -*

(a) *ordinary meeting of the council; and*

(b) *special or urgent meeting of the council, except when time constraints make this impossible.”*

In line with legislated requirements, the publishing of such a schedule of proposed dates for meetings in the media and on the municipal website, seeks to foster a healthy culture of public involvement and participation in Council affairs.

**5. RECOMMENDATIONS**

(a) that the schedule with the proposed dates for Council meetings, Mayoral Committee meetings, Standing Committees and other committees of Council for the 2021 calendar year (attached as **APPENDIX 1**), be noted;

(b) that Council determines that the notice to the public of the time, date and venue of said meetings, as provided for in Section 19 of the Local Government:

---

Municipal Systems Act, 32 of 2000, must be given on the Municipal website and in a newspaper that circulates in the WC024; and

- (c) that it be noted that the Speaker, as provided for in the Standing Rules and Order By-Law and the Systems Act, determines the dates of Council meetings and may call urgent- or special Council meetings over and above the proposed scheduled meetings and may vary the dates in the schedule if and when needed.

## 6. DISCUSSION / CONTENT

### 6.1 Background

A municipality is required to enable the local community to participate in the affairs of the municipality. Sections 17 and 20 of the Local Government: Municipal Systems Act, 32 of 2000, refer to meetings of the municipal council and those of its committees as mechanisms that are open to the public to enable community participation.

As stipulated in Section 19 of the Local Government: Municipal Systems Act, 32 of 2000, *“the municipal manager of a municipality must give notice to the public, in a manner determined by the municipal council, of the time, date and venue of every -*

- (a) *ordinary meeting of the council; and*
- (b) *special or urgent meeting of the council, except when time constraints make this impossible.”*

In line herewith, it is prudent to publish the entire year’s schedule of meetings in order to facilitate effective planning and to foster community participation.

### 6.2 Discussion

The typical pattern used for setting up the monthly cycle of meeting dates is as follows: the Mayoral Committee meeting is on the second Wednesday of the month, and Council meets on the fourth Wednesday of the month. Section 79 and 80 committee meetings are also scheduled monthly as required.

Section 80 committees are established to assist the Executive Mayor in the daily performance and exercise of statutory and delegated functions and powers; therefore, the Section 80 committees will only meet after a referral has been made by the Executive Mayor to the relevant member of the Mayoral Committee for advice on the matter. Meeting dates are provisionally scheduled each month for all of the Section 80 committees although these may not necessarily convene on those dates or at all.

The schedule of proposed dates for meetings, attached as **APPENDIX 1**, indicates the proposed meeting dates and times of Council, the Mayoral Committee, Section 80 (Standing) Committees, and other Statutory Committees of Council. The bi-annual periods that Council will be in recess are also indicated on the schedule.

Notwithstanding the schedule of proposed dates for Council meetings, the Speaker may exercise the prerogative, as provided for in Rule 5 of the Standing Rules and Order By-Law, to also call urgent- or special Council meetings as and when required, which are not reflected in the schedule.

### 6.3 Financial Implications

Meetings are currently held on the virtual MS Teams platform. Expenditure is dealt with in the approved budget.

**6.4 Legal Implications**

The recommendations in this report comply with Council's policies and all applicable legislation, notably the Local Government: Municipal Systems Act; and the Stellenbosch Municipality Rules and Order By-Law.

This item does not require public participation.

**6.5 Staff Implications**

This item has no staff implications for the municipality.

**6.6 Previous / Relevant Council Resolutions**

The Stellenbosch Council ordinarily approves the ensuing year's meeting schedule by November of each year.

**6.7 Risk Implications**

This item has no risk implications for the municipality.

**6.8 Comments from Senior Management****6.8.1 Municipal Manager**

The item and recommendations are supported.

**ANNEXURE**

Appendix 1: Schedule of proposed dates for Council & Committee Meetings for 2021

<b>NAME</b>	<i>Annalene De Beer</i>
<b>POSITION</b>	<i>Director: Corporate Services</i>
<b>DIRECTORATE</b>	<i>Corporate Services</i>
<b>CONTACT NUMBERS</b>	<i>021-808 8018</i>
<b>E-MAIL ADDRESS</b>	<i>Annalene.DeBeer@stellenbosch.gov.za</i>
<b>REPORT DATE</b>	<i>18 November 2020</i>

# APPENDIX 1



**STELLENBOSCH**  
STELLENBOSCH • PNIEL • FRANSCHHOEK  
MUNISIPALITEIT • UMASIPALA • MUNICIPALITY

**SCHEDULE OF PROPOSED DATES FOR  
COUNCIL & COMMITTEE MEETINGS FOR 2021**

DATE	DAY	MEETING	TIME
<b>COUNCIL IN RECESS: 04 DECEMBER 2020 – 10 JANUARY 2021</b>			
<b>JANUARY</b>			
<b>20 January</b>	<b>Wednesday</b>	<b>Mayoral Committee</b>	10:00
25 January	Monday	Local Labour Forum (LLF)	14:00
<b>27 January</b>	<b>Wednesday</b>	<b>COUNCIL</b> <i>Adjustments Budget; Section 52 Budget Report; Section/s 71 and 72 reporting; Draft Annual Report</i>	10:00
<b>FEBRUARY</b>			
02 February	Tuesday	Planning, Local Economic Development & Tourism	14:00
03 February	Wednesday	Human Settlements	10:00
03 February	Wednesday	Rural Management	12:00
03 February	Wednesday	Community and Protection Services	14:00
04 February	Thursday	Youth, Sports & Culture	10:00
04 February	Thursday	Infrastructure Services	14:00
08 February	Monday	Parks, Open Spaces and Environment	10:00
08 February	Monday	Corporate Services	15:00
09 February	Tuesday	Financial Services	14:00
<b>10 February</b>	<b>Wednesday</b>	<b>Mayoral Committee</b>	10:00
18 February	Thursday	Municipal Public Accounts Committee (MPAC)	10:00
22 February	Monday	Local Labour Forum (LLF)	14:00



DATE	DAY	MEETING	TIME
<b>MARCH</b>			
02 March	Tuesday	Planning, Local Economic Development & Tourism	14:00
03 March	Wednesday	Human Settlements	10:00
03 March	Wednesday	Rural Management	12:00
03 March	Wednesday	Community and Protection Services	14:00
04 March	Thursday	Youth, Sports & Culture	10:00
04 March	Thursday	Infrastructure Services	14:00
08 March	Monday	Parks, Open Spaces and Environment	10:00
08 March	Monday	Corporate Services	15:00
09 March	Tuesday	Financial Services	14:00
<b>17 March</b>	<b>Wednesday</b>	<b>Mayoral Committee</b>	10:00
18 March	Thursday	Municipal Public Accounts Committee (MPAC)	10:00
<b>SUNDAY 21 MARCH: HUMAN RIGHTS DAY – 22 MARCH PUBLIC HOLIDAY</b>			
29 March	Monday	Local Labour Forum (LLF)	14:00
<b>31 March</b>	<b>Wednesday</b>	<b>COUNCIL</b> <i>Draft Budget, IDP and SDBIP</i>	10:00
<b>APRIL</b>			
01 April	Thursday	Youth, Sports & Culture	10:00
01 April	Thursday	Infrastructure Services	14:00
<b>FRIDAY 02 APRIL: GOOD FRIDAY // MONDAY 05 APRIL: FAMILY DAY</b>			
06 April	Tuesday	Planning, Local Economic Development & Tourism	14:00
07 April	Wednesday	Human Settlements	10:00
07 April	Wednesday	Rural Management	12:00
07 April	Wednesday	Community and Protection Services	14:00
12 April	Monday	Parks, Open Spaces and Environment	10:00
12 April	Monday	Corporate Services	15:00
13 April	Tuesday	Financial Services	14:00
<b>14 April</b>	<b>Wednesday</b>	<b>Mayoral Committee</b>	10:00
22 April	Thursday	Municipal Public Accounts Committee (MPAC)	10:00
26 April	Monday	Local Labour Forum (LLF)	14:00
<b>TUESDAY 27 APRIL: FREEDOM DAY</b>			
<b>28 April</b>	<b>Wednesday</b>	<b>COUNCIL</b>	10:00

DATE	DAY	MEETING	TIME
<b>MAY</b>			
<b>SATURDAY 01 MAY: WORKERS' DAY</b>			
04 May	Tuesday	Planning, Local Economic Development & Tourism	14:00
05 May	Wednesday	Human Settlements	10:00
05 May	Wednesday	Rural Management	12:00
05 May	Wednesday	Community and Protection Services	14:00
06 May	Thursday	Youth, Sports & Culture	10:00
06 May	Thursday	Infrastructure Services	14:00
10 May	Monday	Parks, Open Spaces and Environment	10:00
10 May	Monday	Corporate Services	15:00
11 May	Tuesday	Financial Services	15:00
<b>12 May</b>	<b>Wednesday</b>	<b>Mayoral Committee</b>	10:00
20 May	Thursday	Municipal Public Accounts Committee (MPAC)	10:00
<b>26 May</b>	<b>Wednesday</b>	<b>COUNCIL Approval of budget and IDP and related documents</b>	10:00
31 May	Monday	Local Labour Forum (LLF)	14:00
<b>JUNE</b>			
01 June	Tuesday	Planning, Local Economic Development & Tourism	14:00
02 June	Wednesday	Human Settlements	10:00
02 June	Wednesday	Rural Management	12:00
02 June	Wednesday	Community and Protection Services	14:00
03 June	Thursday	Youth, Sports & Culture	10:00
03 June	Thursday	Infrastructure Services	14:00
07 June	Monday	Parks, Open Spaces and Environment	10:00
07 June	Monday	Corporate Services	15:00
08 June	Tuesday	Financial Services	14:00
<b>09 June</b>	<b>Wednesday</b>	<b>Mayoral Committee</b>	10:00
<b>WEDNESDAY 16 JUNE: YOUTH DAY</b>			
17 June	Thursday	Municipal Public Accounts Committee (MPAC)	10:00
<b>COUNCIL IN RECESS: 25 JUNE – 18 JULY</b>			

DATE	DAY	MEETING	TIME
<b>JULY</b>			
<b>21 July</b>	<b>Wednesday</b>	<b>Mayoral Committee</b>	10:00
22 July	Thursday	Municipal Public Accounts Committee (MPAC)	10:00
26 July	Monday	Local Labour Forum (LLF)	14:00
<b>28 July</b>	<b>Wednesday</b>	<b>COUNCIL</b> <b>Sec 52 Report on implementation of budget</b>	10:00
<b>AUGUST</b>			
02 August	Monday	Parks, Open Spaces and Environment	10:00
02 August	Monday	Corporate Services	15:00
03 August	Tuesday	Planning, Local Economic Development & Tourism	14:00
04 August	Wednesday	Human Settlements	10:00
04 August	Wednesday	Rural Management	12:00
04 August	Wednesday	Community and Protection Services	14:00
05 August	Thursday	Youth, Sports & Culture	10:00
05 August	Thursday	Infrastructure Services	14:00
<b>MONDAY 09 AUGUST WOMEN'S DAY</b>			
10 August	Tuesday	Financial Services	14:00
<b>18 August</b>	<b>Wednesday</b>	<b>Mayoral Committee</b>	10:00
19 August	Thursday	Municipal Public Accounts Committee (MPAC)	10:00
<b>24 August</b>	<b>Tuesday</b>	<b>COUNCIL</b> <b>Adjustments/Roll-over Budget and Budget/IDP time schedule (Process Plan)</b>	10:00
30 August	Monday	Local Labour Forum (LLF)	14:00

DATE	DAY	MEETING	TIME
<b>SEPTEMBER</b>			
01 September	Wednesday	Human Settlements	10:00
01 September	Wednesday	Rural Management	12:00
01 September	Wednesday	Community and Protection Services	14:00
02 September	Thursday	Youth, Sports & Culture	10:00
02 September	Thursday	Infrastructure Services	14:00
06 September	Monday	Parks, Open Spaces and Environment	10:00
06 September	Monday	Corporate Services	15:00
07 September	Tuesday	Planning, Local Economic Development & Tourism	14:00
14 September	Tuesday	Financial Services	14:00
<b>15 September</b>	<b>Wednesday</b>	<b>Mayoral Committee</b>	10:00
23 September	Thursday	Municipal Public Accounts Committee (MPAC)	10:00
<b>FRIDAY 24 SEPTEMBER: HERITAGE DAY</b>			
27 September	Monday	Local Labour Forum (LLF)	14:00
<b>OCTOBER</b>			
05 October	Tuesday	Planning, Local Economic Development & Tourism	14:00
06 October	Wednesday	Human Settlements	10:00
06 October	Wednesday	Rural Management	12:00
06 October	Wednesday	Community and Protection Services	14:00
07 October	Thursday	Youth, Sport & Culture	10:00
07 October	Thursday	Infrastructure Services	14:00
11 October	Monday	Parks, Open Spaces and Environment	10:00
11 October	Monday	Corporate Services	15:00
12 October	Tuesday	Financial Services	14:00
<b>13 October</b>	<b>Wednesday</b>	<b>Mayoral Committee</b>	10:00
21 October	Thursday	Municipal Public Accounts Committee (MPAC)	10:00
25 October	Monday	Local Labour Forum (LLF)	14:00
<b>27 October</b>	<b>Wednesday</b>	<b>COUNCIL</b> <b>Quarterly report: (Sec 52) implementation</b>	10:00

DATE	DAY	MEETING	TIME
<b>NOVEMBER</b>			
02 November	Tuesday	Planning, Local Economic Development & Tourism	14:00
03 November	Wednesday	Human Settlements	10:00
03 November	Wednesday	Rural Management	12:00
03 November	Wednesday	Community and Protection Services	14:00
04 November	Thursday	Youth, Sports & Culture	10:00
04 November	Thursday	Infrastructure Services	14:00
08 November	Monday	Parks, Open Spaces and Environment	10:00
08 November	Monday	Corporate Services	15:00
09 November	Tuesday	Financial Services	14:00
<b>10 November</b>	<b>Wednesday</b>	<b>Mayoral Committee</b>	10:00
18 November	Thursday	Municipal Public Accounts Committee (MPAC)	10:00
<b>24 November</b>	<b>Wednesday</b>	<b>COUNCIL</b>	10:00
29 November	Monday	Local Labour Forum (LLF)	14:00
<b>DECEMBER</b>			
01 December	Wednesday	Human Settlements	10:00
01 December	Wednesday	Rural Management	12:00
01 December	Wednesday	Community and Protection Services	14:00
02 December	Thursday	Youth, Sports & Culture	10:00
02 December	Thursday	Infrastructure Services	14:00
06 December	Monday	Parks, Open Spaces and Environment	10:00
06 December	Monday	Corporate Services	15:00
07 December	Tuesday	Planning, Local Economic Development & Tourism	14:00
<b>COUNCIL IN RECESS: 10 DECEMBER 2021 – 16 JANUARY 2022</b>			

<b>13.2</b>	<b>AUDIT AND PERFORMANCE AUDIT COMMITTEE CHARTER</b>
-------------	--

Collaborator No:

IDP KPA Ref No:

Meeting Date:

Good Governance

25 November 2020

**1. SUBJECT: AUDIT AND PERFORMANCE AUDIT COMMITTEE CHARTER**

**2. PURPOSE**

To obtain Council's approval of the Audit and Performance Audit Committee Charter attached as **APPENDIX 1**.

**3. DELEGATED AUTHORITY**

Council

**4. EXECUTIVE SUMMARY**

The Audit & Performance Audit Committee reviews its Charter as and when required, based on legislative changes or to implement new best practice principles in line with the IIA standards.

**5. RECOMMENDATION**

that Council approves the Audit and Performance Audit Committee Charter.

**6. DISCUSSION / CONTENTS**

**6.1 Background**

The Audit and Performance Audit Committee is an independent governance structure whose function is to provide an oversight role on the system of internal control, risk management and governance. Governance entails how an organisation is managed, which includes culture, policies and strategies and the way it deals with stakeholders. Section 166 of the MFMA provides for the establishment, composition and frequency of meetings.

The purpose, roles, responsibilities and authority should be clearly documented in a charter (terms of reference). In relation to Municipalities the Council should approve the Audit and Performance Audit Committee Charter. The Stellenbosch Municipality's Audit and Performance Audit Committee Charter was provisionally reviewed and approved by the Audit and Performance Audit Committee at a meeting held by the Committee on the 26<sup>th</sup> August 2020. This charter requires review periodically in order to stay abreast with latest developments and best practice in the fields of Internal Audit, risk management and governance.

The Chief Audit Executive, in consultation with the Audit and Performance Audit Committee and Management, reviewed the charter taking into consideration all applicable legislation and the IIA Standard requirements. This new Audit and Performance Audit Committee Charter appended herewith is now updated and clearly sets out the roles and responsibilities of the Stellenbosch Municipality's Audit and Performance Audit Committee.

---

**6.2 Discussion****Applicable Legislation**

Section 166 of the Local Government: Municipal Finance Management Act 56 of 2003 (MFMA) sets out the following:

- (1) Each municipality and each municipal entity must have an audit committee, subject to subsection (6).
- (2) An audit committee is an independent advisory body which must—
  - (a) advise the municipal council, the political office-bearers, the accounting officer and the management staff of the municipality, or the board of directors, the accounting officer and the management staff of the municipal entity, on matters relating to—
    - (i) internal financial control and internal audits;
    - (ii) risk management;
    - (iii) accounting policies;
    - (iv) the adequacy, reliability and accuracy of financial reporting and information;
    - (v) performance management;
    - (vi) effective governance;
    - (vii) compliance with this Act, the annual Division of Revenue Act and any other applicable legislation;
    - (viii) performance evaluation; and
    - (ix) any other issues referred to it by the municipality or municipal entity;
  - (b) review the annual financial statements to provide the council of the municipality or, in the case of a municipal entity, the council of the parent municipality and the board of directors of the entity, with an authoritative and credible view of the financial position of the municipality or municipal entity, its efficiency and effectiveness and its overall level of compliance with this Act, the annual Division of Revenue Act and any other applicable legislation;
  - (c) respond to the council on any issues raised by the Auditor-General in the audit report;
  - (d) carry out such investigations into the financial affairs of the municipality or municipal entity as the council of the municipality, or in the case of a municipal entity, the council of the parent municipality or the board of directors of the entity, may request; and
  - (e) perform such other functions as may be prescribed.
- (3) In performing its functions, an audit committee—
  - (a) has access to the financial records and other relevant information of the municipality or municipal entity; and
  - (b) must liaise with—
    - (i) the internal audit unit of the municipality; and

- (ii) the person designated by the Auditor-General to audit the financial statements of the municipality or municipal entity.
- (4) An audit committee must—
- (a) consist of at least three persons with appropriate experience, of whom the majority may not be in the employ of the municipality or municipal entity, as the case may be; and
- (b) meet as often as is required to perform its functions, but at least four times a year.
- (5) The members of an audit committee must be appointed by the council of the municipality or, in the case of a municipal entity, by the council of the parent municipality. One of the members who is not in the employ of the municipality or municipal entity, must be appointed as the chairperson of the committee. No councillor may be a member of an audit committee.
- (6) A single audit committee may be established for—
- (a) a district municipality and the local municipalities within that district municipality; and
- (b) a municipality and municipal entities under its sole control.

### 6.3 **Financial Implications**

The Municipality budgets on an annual basis for the remuneration of Audit and Performance Audit Committee members

### 6.4 **Legal Implications**

Section 166 of the MFMA

### 6.5 **Staff Implications**

N/A

### 6.6 **Previous / Relevant Council Resolutions**

N/A

### 6.7 **Risk Implications**

N/A

### FOR FURTHER DETAILS CONTACT:

<b>NAME</b>	Faiz Hoosain
<b>POSITION</b>	<i>Chief Audit Executive</i>
<b>DIRECTORATE</b>	<i>Municipal Manager</i>
<b>CONTACT NUMBERS</b>	<i>0218088555</i>
<b>E-MAIL ADDRESS</b>	<i>Faiz.Hoosain@stellenbosch.gov.za</i>
<b>REPORT DATE</b>	<i>25 November 2020</i>



# APPENDIX 1



**STELLENBOSCH**  
STELLENBOSCH • PNIEL • FRANSCHHOEK

MUNICIPALITY • UMASIPALA • MUNISIPALITEIT

# **Audit and Performance Audit Committee Charter**

(Terms of Reference)

**25 November 2020**

**TABLE OF CONTENTS**

**1 OBJECTIVES ..... 3**

**2 MEMBERSHIP ..... 3**

**3 RESPONSIBILITIES AND DUTIES OF THE AUDIT AND PERFORMANCE  
AUDIT COMMITTEE..... 5**

**4 REPORTING ..... 11**

**5 MEETINGS..... 12**

**6 PROCEEDINGS..... 14**

**7 AUTHORITY OF THE COMMITTEE AND RESOURCES AVAILABLE TO IT ..... 14**

**8 REMUNERATION ..... 15**

## **1 OBJECTIVES**

- 1.1 The objectives of the Audit and Performance Audit Committee are to:
  - 1.1.1 Assist the Council in discharging its duties relating to the safeguarding of Council's assets;
  - 1.1.2 Develop and oversee the operation of an adequate system and internal controls and control processes;
  - 1.1.3 Oversee the preparation of accurate financial reporting and statements in compliance with all applicable legal requirements, corporate governance and accounting standards;
  - 1.1.4 Provide support to the Council on the risk profile and risk management of the Council; and
  - 1.1.5 Ensure that there is an internal audit function in place and that the roles of the internal and external audit functions are co-ordinated.
  
- 1.2 The membership, resources, responsibilities and authorities (composition, functions and operation) of the Audit and Performance Audit Committee to perform its role effectively is stipulated in these terms of reference, which may be amended by Council in consultation with the Audit and Performance Audit Committee Chairperson as and when required.
  
- 1.3 The Audit and Performance Audit Committee is constituted in terms of the requirements of King IV and sound corporate governance practices and operates within that framework (King IV has however not been formally adopted by Council).

## **2 MEMBERSHIP**

- 2.1 The Audit and Performance Audit Committee is Statutory Committee of Council and therefore Council should determine its composition.
  
- 2.2 The recommended composition is that the Audit and Performance Audit Committee shall consist of at least 3 (three) and not more than 5 (five)

independent audit specialists and/or professionals, who have a working knowledge of one or more of the fields of business, finance, legal, engineering, information technology, governance, auditing and/or performance management.

- 2.3 To ensure efficiency and transparency the Chairperson and other members shall be appointed by Council at a Council meeting.
- 2.4 Members shall be appointed for a term of 3 (three) years and, if re-appointed may only serve for one further 3 (three) year term. The terms of appointment of the members appointed in the first year will vary to ensure continuity of expertise in the future.
- 2.5 When a member of the Audit and Performance Audit Committee cannot for any reason continue as a member he / she shall be forthwith replaced by Council. Such a replacement may either be for the balance of the period that the member being replaced would have served for, or a full 3 (three) year period. This shall be at the discretion of the Council on the recommendation of the Municipal Manager in conjunction with the Chief Audit Executive.
- 2.6 The Audit and Performance Audit Committee members shall declare any conflict of interest that may arise and remove themselves from any proceedings and/or discussions in relation to the matter giving rise to that conflict.
- 2.7 An agenda with all supporting documents (meeting pack) shall be circulated, at least seven days prior to each meeting, to the members and invitees of the Audit and Performance Audit Committee.

### **3 RESPONSIBILITIES AND DUTIES OF THE AUDIT AND PERFORMANCE AUDIT COMMITTEE**

- 3.1 The Audit and Performance Audit Committee will be responsible for the oversight of internal controls, financial reporting and compliance with regulatory matters, mainly make recommendations to the Management.
- 3.2 The committee must perform the following responsibilities:
- 3.2.1 Review the effectiveness of the councils system of internal controls and risk management;
  - 3.2.2 Review the financial reporting;
  - 3.2.3 Review the draft annual financial statements and draft annual performance report before submission to AGSA and recommend submission;
  - 3.2.4 Provide advice on IT governance, controls, access, safeguarding of information in the municipality;
  - 3.2.5 Review the Internal Audit function;
  - 3.2.6 Review the Auditor General's report;
  - 3.2.7 Review the Council's compliance with legislation and regulation;
  - 3.2.8 Review the Compliance with the Council's Code of Conduct and ethics;
  - 3.2.9 Performance Management;
  - 3.2.10 Specific expertise may be required from within or outside the municipality from time to time, to assist the Internal Audit Activity and Audit and Performance Audit Committee to formulate recommendations on systems and controls. The committee may have to advise on the appropriateness of disaster recovery and continuity plans supporting IT risks, regular testing and evaluation of plans, systems and processes; and
  - 3.2.11 Other Responsibilities as determined by legislation and by Council from time to time.
- 3.3 The Audit and Performance Audit Committee shall advise Council, political office bearers, the accounting officer and management of the municipality on the matters pertaining to the duties listed above in accordance with section 166 of the Local Government: Municipal Finance Management Act 56 of 2003 (MFMA).

**3.4 INTERNAL CONTROL**

The Audit and Performance Audit Committee shall:

- 3.4.1 Review whether management has implemented internal controls and business risk management as well as getting assurance from management that all employees have an understanding of their roles in executing these controls effectively;
- 3.4.2 Review whether management implemented internal controls, as recommended by internal and external auditors;
- 3.4.3 Review management's control of Council assets and the efficient and effective utilisation thereof; and
- 3.4.4 Review whether management has an efficient risk management policy in place as well as the necessary and appropriate personnel to implement same.

**3.5 FINANCIAL, GENERAL**

The Audit and Performance Audit Committee shall:

- 3.5.1 Review any activity of the Council, with the full co-operation of all employees as requested by the members of the Committee;
- 3.5.2 Obtain the services of professionals if necessary to assist the Committee in the executing of its responsibilities; and
- 3.5.3 Discuss with management the Council's major financial risk exposures and the steps management has taken to monitor and control such exposures, including proposed future requirements

**3.6 FINANCIAL STATEMENTS**

The Audit and Performance Audit Committee shall

- 3.6.1 Review and discuss with management and the Auditor General the annual audited financial statements and the results of the audit;
- 3.6.2 Review significant accounting and reporting issues and understand their impact on the financial statements. These issues include:

- 3.6.2.1 Complex or unusual transactions and highly judgmental areas;
- 3.6.2.2 Major issues regarding accounting principles and financial statement presentations, including any significant changes in the Council's selection or application of accounting principles;
- 3.6.2.3 The effect of regulatory and accounting initiatives, as well as off-balance sheet structures, on the financial statements of Council;
- 3.6.2.4 Review analyses prepared by management and/or the independent auditor setting forth significant financial reporting issues and judgments made in connection with the preparation of the financial statements, including analyses of the effects of alternative GRAP methods on the financial statements;
- 3.6.2.5 Review with management and the external auditors the results of the audit, including any difficulties encountered. This review will include any restrictions on the scope of the independent auditor's activities or on access to requested information, and any significant disagreements with management;
- 3.6.2.6 Discuss the annual audited financial statements with management and the external auditors; and
- 3.6.2.7 Review disclosures made by Municipal Manager and Chief Financial Officer about significant deficiencies in the design or operation of internal controls or any fraud that involves management or other employees who have a significant role in the Council's internal controls.

### 3.7 **INTERNAL AUDIT**

The Audit and Performance Audit Committee shall:

- 3.7.1 Review and approve the three year rolling internal audit plan, annual audit plan and charters of the Internal Audit Department and ensure that the audit plan makes provision for effectively addressing the risk areas;
- 3.7.2 All changes to the annual internal audit plan are to be submitted to the Audit and Performance Audit Committee for approval;
- 3.7.3 Review the activities and organisational structure of the internal audit department and ensure that there are no unjustified restrictions or limitations and that they have independence;



- 3.7.4 Review all audit reports by the Internal Auditors and determine whether management acted on recommendations that are made;
- 3.7.5 Determine whether the Internal Audit function is adequately resourced and has appropriate standing in the Municipality, and concur with the Municipal Manager in the appointment, replacement, reassignment or dismissal of the Chief Audit Executive;
- 3.7.6 Ensure that that Internal Audit function is subject to an independent quality review every 5 (five) years and complies with The Institute of Internal Auditors' International Standards for the Professional Practice of Internal Auditing;
- 3.7.7 Determine whether the Internal Auditors have an effective relationship with the Auditor General's staff;
- 3.7.8 Review significant differences of opinion between management and the Internal Audit function;
- 3.7.9 Review and evaluate the performance of the Internal Audit function and the Chief Audit Executive;
- 3.7.10 Review the independence and objectivity of the Chief Audit Executive; and
- 3.7.11 Meet with the Chief Audit Executive to discuss confidential matters.
- 3.7.12 The Chief Audit Executive shall have unrestricted access to the chairperson or any other member of the Audit and Performance Audit Committee as required.
- 3.7.13 The Chief Audit Executive must ensure that sufficient funds are budgeted for the activities of the Audit and Performance Audit Committee.

### **3.8 AUDITOR GENERAL**

The Audit and Performance Audit Committee shall:

- 3.8.1 Review the Auditor General's proposed audit scope and approach and ensure that no unjustified restrictions or limitations are placed on the scope;
- 3.8.2 Make suggestions as to risk areas that the audit can address;
- 3.8.3 Identify key matters arising in the current year's audit report and satisfy themselves that these are properly followed up by management;

- 3.8.4 Consider whether any significant ventures, investments or operations should be subjected to an independent audit;
- 3.8.5 Ensure the independence of the Auditor General;
- 3.8.6 Ensure direct access by the Auditor General to the Audit and Performance Audit Committee, the Chairperson of the Audit and Performance Audit Committee and the Municipal Manager;
- 3.8.7 Review reports of significant findings and recommendations made by the Auditor General, and management's response and follow-up actions to these reports;
- 3.8.8 Review draft unaudited annual financial statements, annual performance report and Auditor General's audit report, prior to submission to Council for approval; and
- 3.8.9 Meet with the Auditor General to discuss confidential matters.

### 3.9 **COMPLIANCE WITH LAWS AND REGULATIONS**

The Audit and Performance Audit Committee shall:

- 3.9.1 Review the effectiveness of the system for monitoring compliance with laws and regulations and the result of management's investigation and follow up of any fraudulent acts (including disciplinary actions);
- 3.9.2 Ensure that all regulatory compliance matters have been considered in the preparation of the financial statements; and
- 3.9.3 The Committee will have the responsibility to discuss legal matters with management that may have a material impact on the financial statements or the Council's compliance policies.

### 3.10 **COMPLIANCE WITH CODES OF CONDUCT AND ETHICS**

The Audit and Performance Audit Committee shall:

- 3.10.1 Advise the Municipal Manager and Speaker in ensuring that all councillors and staff are aware of the codes of conduct;
- 3.10.2 Review the process for monitoring compliance with the codes of conduct; and
- 3.10.3 Monitor the ethical conduct of the Council, executive and senior officials.

**3.11 PERFORMANCE MANAGEMENT**

The Audit and Performance Audit Committee shall:

- 3.11.1 Review Council's performance management system, focusing on the key performance indicators and targets set by Council; and
- 3.11.2 Review reports from the Auditor General's audit and Internal Audit reports in respect of Performance Management and make recommendations to Council.

**3.12 OTHER RESPONSIBILITIES**

- 3.12.1 The Committee will have the power to investigate any matter, internal controls, fraud, misconduct and conflict of interest, brought to its attention within the scope of its duties, with the power to obtain outside advice or expertise if necessary.
- 3.12.2 The Audit and Performance Audit Committee will review and reassess the adequacy of this Charter and report annually to Council any recommended changes for its (Council's) approval, if necessary.
- 3.12.3 The Audit and Performance Audit Committee will annually review the Audit and Performance Audit Committee's own performance and present such review to the Council.
- 3.12.4 The Audit and Performance Audit Committee shall, with the approval of the Council and at the Council's expense, to the extent it deems necessary or appropriate, obtain the services of special independent legal, accounting or other consultants to advise the Audit and Performance Audit Committee in fulfilling its obligations.
- 3.12.5 The Audit and Performance Audit Committee shall have:
  - 3.12.5.1 Direct access to the Chief Audit Executive;
  - 3.12.5.2 Direct access to Council;
  - 3.12.5.3 Access to the office of the Executive Mayor; and
  - 3.12.5.4 Access to the office of the Municipal Manager.

3.12.6 Combined Assurance

3.12.6.1 The Audit and Performance Audit Committee is responsible for ensuring that the combined assurance model introduced by King IV is applied to provide a coordinated approach to all assurance activities.

3.12.6.2 In particular to King IV, the Audit and Performance Audit Committee:

3.12.6.2.1 Will ensure that the combined assurance received is appropriate to address all the significant risks facing the Council; and

3.12.6.2.2 Will monitor the relationship between external service providers and the Council.

3.12.6.3 The Audit and Performance Audit Committee is an integral component of the risk management process and shall oversee:

3.12.6.3.1 Financial reporting risks;

3.12.6.3.2 Internal financial controls;

3.12.6.3.3 Fraud risks as it relates financial reporting;

3.12.6.3.4 IT risks as it relates to financial reporting; and

3.12.6.3.5 Compliance risks

**4 REPORTING**

4.1 The Audit and Performance Audit Committee must submit quarterly reports to Council for information.

4.2 The Committee must report annually to the Council, summarising the activities, recommendations and decisions, which can be included in the annual statements.

4.3 The chairperson of the Audit and Performance Audit Committee or his/her nominee shall attend the Council meeting when the report is presented to answer questions concerning matters falling within the ambit of the Audit and Performance Audit Committee.

**5 MEETINGS**

- 5.1 Council's Committee Secretariat Department or such other department as responsible for the function determined by the Council, will supply secretarial support to the Audit and Performance Audit Committee, including the preparation and distribution of all agendas and minutes of meetings.
- 5.2 The Audit and Performance Audit Committee shall meet as often as the Chairperson determines, but not less frequently than 4 (four) times during each a financial year.
- 5.3 The Municipal Manager, Chief Financial Officer and the Chief Audit Executive are obliged to attend all meetings of the Audit and Performance Audit Committee, provided that the Chairperson of the Audit and Performance Audit Committee may excuse any of these non-members from the meeting.
- 5.4 Other members of management may at the discretion of the Chairperson of the Audit and Performance Audit Committee be invited to attend Audit and Performance Audit Committee meetings, and shall be obliged to attend.
- 5.5 As necessary or desirable, the Audit and Performance Audit Committee may invite such other persons, including a representative from the office of the Auditor General to attend a meeting of the Audit and Performance Audit Committee, as it deems necessary and appropriate.
- 5.6 The Chairperson of the Audit and Performance Audit Committee shall convene all meetings of the Audit and Performance Audit Committee.
- 5.7 The Chairperson and the Chief Audit Executive shall be responsible to compile the agendas. An electronic or written agenda (meeting pack) for each meeting should be sent to all persons who are to attend the meeting in advance, not less than seven days prior to the date of the Audit and Performance Audit Committee meeting, along with any other relevant

information or documentation for allowing adequate preparation to contribute to a more effective meeting.

- 5.8 Any member of the Audit and Performance Audit Committee may add items to the agenda at least 8 (eight) working days prior to the date of the Audit and Performance Audit Committee meeting. Such items shall be provided to the Chairperson or the Chief Audit Executive.
- 5.9 Special meetings of the Audit and Performance Audit Committee may be convened with the Chairperson's approval. Any member of the Audit and Performance Audit Committee, the Internal or External Auditors may request a special meeting if they consider that one is necessary.
- 5.10 3 (Three) members will form a quorum, and if the chairperson is absent, the members that are present, shall elect 1 (one) of those members present to serve as chairperson for that meeting.
- 5.11 If there is no quorum the meeting will be adjourned to a new date and time as determined by the Chairperson, not exceeding 2 (two) weeks.
- 5.12 The members of the Audit and Performance Audit Committee as appointed by Council, and excluding the management of the Municipality, are the only persons with voting rights. Voting shall be by a show of hands unless decided by all members that it be by ballot. The Chairperson shall have a casting vote in the event that the votes are tied.
- 5.13 If a member wishes to dissent or protest against a decision he or she may request that it is recorded in the minutes.

**6 PROCEEDINGS**

- 6.1 Unless varied by these terms of reference, meetings and proceedings of the Committee will be governed by the Municipality's Rules of Order as adopted by Council or any other municipal guidelines regulating the meetings and proceedings of committees as adopted by Council from time to time.
  
- 6.2 The minutes of meetings shall be reviewed and approved by the members of the Committee at the following meeting of the Audit and Performance Audit Committee.

**7 AUTHORITY OF THE COMMITTEE AND RESOURCES AVAILABLE TO IT**

The Audit and Performance Audit Committee, in carrying out its tasks under these terms of reference:

- 7.1 Is authorised to investigate any activity within its terms of reference;
  
- 7.2 May, at the discretion of the Audit and Performance Audit Committee, require other employees of the municipality to attend its meetings or any part(s) of its meetings;
  
- 7.3 May consult with and seek any information it requires from any employee, and all employees shall be required to co-operate with any request made by the Audit and Performance Audit Committee in the course of its duties. Such requests shall be directed to the Chairperson of the Audit and Performance Audit Committee or the Chief Audit Executive;
  
- 7.4 Shall meet with external auditors without any officials / politicians in attendance at least once a year; and
  
- 7.5 Shall meet with the internal auditors without any officials / politicians in attendance at least once year.

**8 REMUNERATION**

- 8.1 Remuneration shall be on the basis of a fixed rate per meeting. This rate will include all preparation time utilised by members for meetings. The rate per meeting for ordinary members is R5 000, 00 (five thousand Rand) per meeting and R6 000, 00 (six thousand Rand) per meeting for the Chairperson of the Committee. Remuneration will be reviewed on an annual basis effective 1 July every year.
  
- 8.2 Travel cost will be paid for members travelling outside of the Greater Stellenbosch in line with the Municipality's Travel and Subsistence Policy.
  
- 8.3 Remuneration will be in accordance with the above tariff as approved by the Council.
  
- 8.4 The effectiveness of the Audit and Performance Audit Committee will be monitored by Council, annually.

**Executive Mayor** : .....

**Initials and Surname** : .....

**Date:** : .....

**Chairperson: Audit and Performance Audit Committee.....**

**Initials and Surname** : .....

**Date** : .....

**Municipal Manager** : .....

**Initials and Surname** : .....

**Date** : .....



13.3	<b>INTERNAL AUDIT CHARTER</b>
------	-------------------------------

Collaborator No:

IDP KPA Ref No:

Meeting Date:

Good Governance

25 November 2020

**1. SUBJECT: INTERNAL AUDIT CHARTER**

**2. PURPOSE**

To obtain Council's approval of the Internal Audit Charter attached as **APPENDIX 1**.

**3. DELEGATED AUTHORITY**

Council

**4. EXECUTIVE SUMMARY**

Section 62 of the MFMA requires amongst others, that the accounting officer of a municipality must take all reasonable steps to ensure that the municipality has and maintains effective, efficient and transparent systems of internal audit operating in accordance with any prescribed norms and standards. The Terms of reference for Internal Audit is updated as when required taking into consideration legislative changes if any and best practice guidance in line with the IIA Standards. The Internal Audit Charter was reviewed by Management and the Audit and Performance Audit Committee and recommended to Council for approval at a meeting of the committee dated 26 August 2020.

**5. RECOMMENDATION**

that Council approves the Internal Audit Charter.

**6. DISCUSSION / CONTENTS**

**6.1 Background**

Section 165 of the MFMA prescribes the establishment of the internal audit activity. Internal audit is an important component of internal control, risk management and corporate governance and provides the necessary assurance and advisory services to the organisation. Internal audit activity is one of the most significant management tools and can provide value added services to the municipality or municipal entity. When objectively and adequately resourced, internal audit should be in a position to provide management with assurance regarding the effectiveness of the system of internal control, risk management and governance processes.

The Internal Audit Charter outlines the mandate of internal audit and serves as the statement of purpose, authority and responsibility. The charter must be in writing and address the following:

- The internal audit's purpose, authority and responsibilities;
- The standards to be complied with;
- The position of the internal audit within the organisation;
- A description of assurance and nature of consulting services;
- The period of review of the charter;
- The appointment and the dismissal of the chief audit executive; and
- Access to information, properties and personnel

---

The charter must be approved by the Audit and Performance Audit Committee and accepted by the Accounting Officer.

## 6.2 Discussion

### **Applicable Legislation**

Section 165 of the Local Government: Municipal Finance Management Act 56 of 2003 (MFMA)

- (1) *Each municipality and each municipal entity must have an internal audit unit, subject to subsection (3).*
- (2) *The internal audit unit of a municipality or municipal entity must*
  - (a) *prepare a risk-based audit plan and an internal audit program for each financial year;*
  - (b) *advise the accounting officer and report to the audit committee on the implementation of the internal audit plan and matters relating to—*
    - (i) *internal audit;*
    - (ii) *internal controls;*
    - (iii) *accounting procedures and practices;*
    - (iv) *risk and risk management;*
    - (v) *performance management;*
    - (vi) *loss control; and*
    - (vii) *compliance with this Act, the annual Division of Revenue Act and any other applicable legislation;*
  - (c) *perform such other duties as may be assigned to it by the accounting officer.*
- (3) *The internal audit function referred to in subsection (2) may be outsourced if the municipality or municipal entity requires assistance to develop its internal capacity and the council of the municipality or the board of directors of the entity has determined that this is feasible or cost-effective.*

## 6.3 Financial Implications

N/A

## 6.4 Legal Implications

Section 165 of the MFMA

## 6.5 Staff Implications

N/A

---

**6.6 Previous / Relevant Council Resolutions**

N/A

**6.7 Risk Implications**

N/A

**FOR FURTHER DETAILS CONTACT:**

<b>NAME</b>	Faiz Hoosain
<b>POSITION</b>	<i>Chief Audit Executive</i>
<b>DIRECTORATE</b>	<i>Municipal Manager</i>
<b>CONTACT NUMBERS</b>	<i>0218088555</i>
<b>E-MAIL ADDRESS</b>	<i>Faiz.Hoosain@stellenbosch.gov.za</i>
<b>REPORT DATE</b>	<i>25 November 2020</i>

# APPENDIX 1



**STELLENBOSCH**  
STELLENBOSCH • PNIEL • FRANSCHHOEK

MUNICIPALITY • UMASIPALA • MUNISIPALITEIT

# **Internal Audit Charter**

**25 November 2020**

**TABLE OF CONTENTS**

	<b>Page</b>
1. INTRODUCTION	3
2. PURPOSE OF INTERNAL AUDIT	3
3. ACCOUNTABILITY	3
4. INDEPENDENCE	4
5. RESPONSIBILITIES	4
6. AUTHORITY	5
7. COMBINED ASSURANCE	5
8. LIMITATION OF SCOPE	5
9. RESTRICTIONS	5
10. STANDARDS AND CODE OF ETHICS	5
11. REVIEW PERIOD	6

## INTERNAL AUDIT CHARTER

### 1. Introduction:

The Council and Audit and Performance Committee is responsible for overseeing the establishment of effective systems of internal control in order to provide reasonable assurance that Stellenbosch Municipality's financial and non-financial objectives are achieved. Executing this responsibility includes the establishment of an internal audit function in accordance with this document.

Internal control is understood to mean the processes aimed at achieving reasonable assurance about the realisation of the following objectives:

- The accomplishment of established objectives and goals for operations and programmes.
- The economical and efficient use of resources.
- The reliability and integrity of financial and non-financial information.
- Compliance with relevant policies, procedures, laws and regulations.
- Safeguarding of assets.

This document defines the Internal Audit Activity's purpose, responsibilities and authority.

### 2. Purpose of internal audit:

Internal Audit is an independent, objective assurance and consulting activity designed to add value and improve Stellenbosch Municipality's operations. It helps Stellenbosch Municipality to accomplish its objectives by bringing a systematic, disciplined approach to evaluate and improve the effectiveness of risk management, control and governance processes.

### 3. Accountability:

The Chief Audit Executive (CAE), in the discharge of his or her duties, shall report administratively and be accountable to the Audit and Performance Audit Committee to:

- Provide an annual assessment on the adequacy and effectiveness of the organisation's process for controlling its activities and managing its risks in the areas set forth in this charter.
- Report significant issues related to the processes for controlling activities of the organisation and its entities, including potential improvements to those processes and provide information concerning such issues for further actions by management.
- Provide information periodically on the status and results of the annual audit plan and the sufficiency of department resources.
- Coordinate with and provide oversight of other control and monitoring functions (risk management, compliance, security, legal, and ethics, environmental and external audit).
- Handle documents and information given to Internal Audit during a period review in the same prudent and confidential manner as by those employees normally accountable for it.

#### 4. Independence:

- To provide for the independence of the Internal Audit Activity (IAA), the CAE and personnel report functionally to the Audit and Performance Committee and administratively to the Accounting Officer.
- The Audit and Performance Committee must concur on the appointment or removal of the CAE.
- The CAE has a standing invitation to attend meetings of the executive committee or other committees made up of a majority of senior executives, but is not a member of these committees in order to protect independence.
- All internal audit activities shall remain free of influence by any element in the organisation, including matters of:
  - Audit selection;
  - Scope;
  - Procedures;
  - Frequency;
  - Timing; or
  - Report content to permit maintenance of an independent and objective mental attitude necessary in rendering reports.
- Internal Auditors shall have no direct operational responsibility or authority over any of the activities they review.
- When performing consulting engagements, the nature and scope of the engagement are agreed with the management prior to its commencement. The internal auditors will not assume any management responsibilities during and after the engagement.
- The organisational structure must promote the independence of the internal audit function as a whole and allow internal audit to form its judgements objectively.

#### 5. Responsibilities:

The Chief Audit Executive and Internal Audit staff members have amongst others the following responsibilities:

- Develop a three year strategic and flexible internal audit plan using appropriate risk-based methodology, including any risks or control concerns identified by management, and submit that plan to the Audit and Performance Committee for review and approval.
- Implement the annual audit plan, as approved, including, and as appropriate, any special tasks or projects requested by management and the Audit and Performance Committee.
- Establish policies and procedures to guide the Internal Audit staff and direct its administrative functions.
- Maintain a professional audit staff with sufficient knowledge, skills and experience to meet the requirements of this charter.
- Establish a quality assurance program by which the Chief Audit Executive assures the operation of internal audit activities.
- Perform consulting services, beyond internal auditing assurance services, to assist management in meeting its objectives. Examples may include facilitation, training and advisory services. Informal consulting engagements include routine activities such as participating on standing committees, limited life projects, ad hoc meetings and routine information exchange. Whilst performing these activities independence should not be impaired.
- Stay informed on improvements and current developments in internal audit standards, procedures and techniques, including The Institute of Internal Auditors (IIA's) International Professional practices Framework guidance. Continuing professional education (CPE) may be obtained through membership, participation and volunteering in professional



organisations such as The IIA, attendance at conferences, seminars, in-house training programs, completion of college and self-study courses and involvement in research projects.

- The Chief Audit Executive and the Internal Audit staff must be members of the South African Institute of Internal Auditors. Membership Fees for the IIA must form part of the annual operational budget of the Internal Audit Unit and is payable by Stellenbosch Municipality annually.

#### **6. Authority:**

The CAE and Internal Audit Staff are authorised amongst other things to:

- Have full, free and unrestricted access to any and all of the municipalities' records, physical properties and personnel relevant to any function under review.
- Have full, free and unrestricted access to the Council and the Audit and Performance Committee of the Council.
- Allocate resources, set frequencies, select subjects, determine scopes of work and apply the techniques required to accomplish audit objectives.
- Obtain the necessary assistance of personnel in units of the organisation where they perform audits, as well as other specialised services from within or outside the organisation.

#### **7. Combined Assurance:**

Internal audit must make an assessment of the adequacy of the combined assurance approach adopted by Stellenbosch Municipality. This assessment includes the adequacy of risks covered by the different assurance providers and the reliability of the assurance provided.

#### **8. Limitation of scope:**

Any attempted scope limitation by management must be reported, preferably in writing, to the Audit and Performance Audit Committee.

#### **9. Restrictions**

The CAE and staff of the IAA are **not** authorised to:

- Perform any operational duties for the organisation or its affiliates.
- Initiate or approve accounting transactions external to the internal auditing department
- Direct the activities of any of the organisation's employee's not employed by the internal audit department, except to the extent that such employees have been appropriately assigned to auditing teams or to otherwise assist the internal auditors.

#### **10. Standards and Code of Ethics:**

Internal audit will seek to meet or exceed the IIA Standards and abide by the Code of Ethics as outlined in the International Standards for the Professional Practice of Internal Auditing (ISPPIA).

**11. Review Period:**

This charter will be reviewed every three years and/ or when material amendments are needed whereupon it will be submitted to the Audit and Performance Audit Committee for approval.

**Accepted by Accounting Officer**

**Date**

**Approved by Audit and Performance Committee**

**Date**

<b>13.4</b>	<b>REQUEST FOR APPROVAL OF STELLENBOSCH MUNICIPALITY DRAFT BY-LAW ON STORMWATER</b>
-------------	---

Collaborator No: 696719  
IDP KPA Ref No: Good Governance and Compliance  
Meeting Date: 05 November 2020

**1. SUBJECT: REQUEST FOR APPROVAL OF STELLENBOSCH MUNICIPALITY DRAFT BY-LAW ON STORMWATER**

**2 PURPOSE**

That Council notes and approves the Draft By-Law on Stormwater.

**3. DELEGATED AUTHORITY**

Municipal Council, however the Mayor may request the Portfolio Committee to render assistance in terms of Section 80 of the Local Government Municipal Structures Act, Act 117 of 1998, as amended.

**4. EXECUTIVE SUMMARY**

The Draft By-Law on Stormwater gives effect to rights contained in Section 24 of the Constitution, of the Republic of South Africa, 1996, and Section 11 of the Local Government Municipal Systems Act 200 (Act 32 of 2000), where, a Local Government may proclaimate By-Laws to govern the services that is delivered to the constituencies of the Republic of South Africa.

The Draft By-Law on Stormwater regulates stormwater systems in built-up areas and regulates activities which may have a detrimental effect on the development, operation or maintenance of the stormwater system.

The By-Law aims to improve the management of stormwater systems in a sustainable manner with due consideration for the scarce resource, reducing the impacts flooding (on community lively hoods, regional communities, residents, businesses ect.), preventing damage to properties, safeguarding human health, protecting natural aquatic environments and maintaining acceptable water quality within the stormwater system.

**5. RECOMMENDATIONS**

- (a) that the Draft By-Law on Stormwater, attached as **ANNEXURE A**, be accepted as the Final By-Law as per Section 12(2) to 12(4) & 13.
- (b) that Council notes that a public participating process was followed and that no comment or feedback was received.

**6. DISCUSSION / CONTENTS**

**6.1 Background**

Stormwater systems in older residential areas at times do not effectively accommodate stormwater runoff; this is increasingly evident with the effects of climate change and the higher intensity rainfall currently being experienced.

The Directorate Infrastructure services currently utilizes standard technical Guidelines to regulates and control stormwater systems, these Guidelines are utilized when stipulating conditions of approval for new developments. Although the guidelines make allowance for the impacts of climate change for new developments, the increase in

intensity of rainfall, experienced over the past +- 7 years, are still impacting the existing stormwater systems, with portions of the system traversing over private property.

## 6.2 Discussion

Technical guidelines, policies by other municipalities on the management of stormwater systems were reviewed and assessed. Comparative reviews of a number of Stormwater By-Laws, also promulgated by other Municipalities were carried out. Our stormwater By-Law was then compiled based on these reviews and assessments.

The Draft By-Law on Stormwater regulates the stormwater systems and associated activities by defining and regulating functions and activities which are allowable, and prohibits activities that are hazardous and damaging. The By-Law also empowers the Municipality to act on infringements on the Stormwater system. Below are some of the aspects addressed by the By-Law:

- Applications for permits, consent or authorisation
- Prohibited discharges
- Measures to protect stormwater systems
- Sustainable urban drainage systems
- Stormwater Management Plans
- Stormwater systems on private land
- Provision of infrastructure
- Offences and penalties

The Directorate Infrastructure Services intends, together with this By-Law, to replace the Guidelines with a Stormwater Policy, for improved legislative control over stormwater systems within the municipal area.

Council has noted the draft By-law and that it would be circulated for public comment. The public commenting period was between 14 September 2020 until 14 October 2020 (**ANNEXURE B**). The public was notified with an advertisement that was placed in the media "Die Burger" and on the Municipal website. No comments or objections were received.

## 6.3 Financial Implications

None

## 6.4 Legal Implications

The Stormwater By-Law may reduce Municipal liabilities (third party claims) as it allows for more effective control of stormwater systems within the Municipal area.

**"12. *Legislative procedures.***—(1) *Only a member or committee of a municipal council may introduce a draft by-law in the council.*

- (2) *A by-law must be made by a decision taken by a municipal council—*
  - (a) *in accordance with the rules and orders of the council; and*
  - (b) *with a supporting vote of a majority of its members.*
- (3) *No by-law may be passed by a municipal council unless—*
  - (a) *all the members of the council have been given reasonable notice; and*
  - (b) *the proposed by-law has been published for public comment in a manner that allows the public an opportunity to make representations with regard to the proposed by-law.*
- (4) *Subsections (1) to (3) also apply when a municipal council incorporates by reference, as by-laws, provisions of—*

- (a) *legislation passed by another legislative organ of state; or*
- (b) *standard draft by-laws made in terms of section 14.*

- 13. Publication of by-laws.**—*A by-law passed by a municipal council—*
- (a) *must be published promptly in the Provincial Gazette, and, when feasible, also in a local newspaper or in any other practical way to bring the contents of the by-law to the attention of the local community; and*
  - (b) *takes effect when published or on a future date determined in or in terms of the by-law.”*

**6.5 Staff Implications**

None

**6.6 Previous / Relevant Council Resolutions:**

**37<sup>TH</sup> COUNCIL MEETING: 2020-08-24: ITEM 11.5.3**

**RESOLVED** (nem con)

- (a) that the content of this report be noted;
- (b) that the Draft By-Law on Stormwater, attached as **ANNEXURE A**, be accepted as per Section 12(1) of the Municipal Systems Act, as amended; and
- (c) that a Public Participation process be launched as per Section 12(3)(b) and Section 21 of the Municipal Systems Act.

**6.7 Risk Implications**

None

**RECOMMENDATIONS FROM INFRASTRUCURE SERVICES COMMITTEE MEETING TO THE EXECUTIVE MAYOR: 2020-11-05: ITEM 5.1.1 (RECOMMENDATIONS TO COUNCIL)**

- (a) that the Draft By-Law on Stormwater, attached as **ANNEXURE A**, be accepted as the Final By-Law as per Section 12(2) to 12(4) & 13; and
- (b) that Council notes that a public participation process was followed and that no comment or feedback were received.

**ANNEXURES**

Annexure A: Draft By-Law on Stormwater  
Annexure B: Advertisement Notice for Comments

**FOR FURTHER DETAILS CONTACT:**

<b>NAME</b>	Deon Louw
<b>POSITION</b>	<b>Director</b>
<b>DIRECTORATE</b>	<b>Infrastructure Services</b>
<b>CONTACT NUMBERS</b>	<b>021 808 8213</b>
<b>E-MAIL ADDRESS</b>	<b>Deon.louw@stellenbosch.gov.za</b>
<b>REPORT DATE</b>	<b>22 October 2020</b>

# **ANNEXURE A**

[LOCAL AUTHORITY NOTICE OF XXX.]

[DATE OF COMMENCEMENT: XXX.]

This By-Law

was published by *Provincial Gazette* No. XXX dated XXX.

STELLENBOSCH MUNICIPALITY

BY-LAW RELATING TO STORMWATER

APPROVED BY COUNCIL ON XXX

AND

PROMULGATED IN TERMS OF SECTION XXX OF THE LOCAL GOVERNMENT:  
MUNICIPAL SYSTEMS ACT, 2000 (ACT 32 OF 2000)

STELLENBOSCH MUNICIPALITY STORMWATER BY-LAW  
(20XX)

To give effect to the right contained in section 24 of the Constitution of the Republic of South Africa, 1996 and to regulate –

- the stormwater management systems in built-up areas; and
- activities which may have a detrimental effect on the development, operation or maintenance of the stormwater system.

Under the provisions of sections 156 (2) of the Constitution of the Republic of South Africa, 1996, and section 11 of the Local Government: Municipal Systems Act, 2000 (Act 32 of 2000) the Municipality of Stellenbosch enacts as follows:

## TABLE OF CONTENTS

<b>Preamble</b>	
<b>1. Definitions</b>	<b>3</b>
<b>2. Aim, application and scope</b>	<b>7</b>
<b>3. Stormwater policies and guidelines</b>	<b>8</b>
<b>4. Applications for permits, consent or authorisation</b>	<b>9</b>
<b>5. Prohibited discharges</b>	<b>9</b>
<b>6. Measures to protect stormwater system</b>	<b>9</b>
<b>7. Sustainable urban drainage system</b>	<b>11</b>
<b>8. Stormwater management plan</b>	<b>12</b>
<b>9. Stormwater systems on private land</b>	<b>13</b>
<b>10. Provision of infrastructure</b>	<b>13</b>
<b>11. General powers</b>	<b>14</b>
<b>12. Appeal</b>	<b>14</b>
<b>13. Exemptions</b>	<b>15</b>
<b>14. Community liaison forums</b>	<b>15</b>
<b>15. Offences and penalties</b>	<b>15</b>
<b>16. Repeal of By-laws</b>	<b>16</b>
<b>17. Short title and commencement</b>	<b>16</b>



## PREAMBLE

WHEREAS the Municipality has under the Constitution, legislative competence in respect of stormwater management systems in built-up areas;

Whereas the Municipality has an obligation to regulate and control stormwater systems in built-up areas so as to ensure a safe, healthy and sustainable environment and to ensure that the rights of individuals are protected;

Whereas the Municipality wishes to reduce the environmental impact of stormwater to ensure that the socio-economic development, the health of the people within the Municipality's boundaries and the quality of environmental resources are not unduly adversely affected by stormwater;

Whereas the Municipality wants to ensure that all residents, organisations, institutions, businesses, visitors or tourists and government departments enjoy the services from a legitimate stormwater management service provider;

Whereas the Municipality wishes to regulate the stormwater management systems in built-up areas and the regulation of facilities used for the management of stormwater, with the aim of avoiding or minimising the damage to the environment; and

Whereas the Municipality intends to minimise the undesirable impacts of stormwater runoff from developed areas in accordance with Water Sensitive Urban Design Principles.

BE IT ENACTED by the Municipality, as follows: —

**1. Definitions.** —In this By-law, words used in the singular includes the plural and vice versa, the English text shall prevail in the event of an inconsistency between the different texts, and, unless the context otherwise indicates –

“**Best Management Practices**” refer to devices, practices or methods to –

- (a) prevent, remove, eliminate, reduce or impede runoff flows; or
- (b) prevent targeted stormwater runoff constituents, pollutants and contaminants from reaching receiving waters,

and include structural and non-structural controls and devices, and operation and management procedures;

“**built-up areas**” mean those portions or areas of the Municipality which are divided into erven by means of physical survey or which are surrounded by surveyed erven, including the public roads adjacent thereto as well as portions or areas falling within the urban edge of the approved Spatial Development Framework;

“**catchment**” means the area from which any rainfall will drain into a watercourse or wetland, or part thereof, through surface flow to a common point or points;

**“Council”** means the Council of the Municipality of Stellenbosch;

**“detention basin”** means a storage site (such as a small reservoir) that delays the flow of water downstream;

**“development”** means any man-made change to, or associated preparation of, property, including but not limited to, construction or upgrading of buildings or other structures, filling, paving and municipal services;

**“flood attenuation measures”** means –

- (a) assessing the effects of any increased runoff on the existing downstream stormwater system, and
  - (b) preparing and implementing the development plan in such a way that –
    - (i) the peak flow immediately downstream of the planned development; and
    - (ii) where existing detention storage is provided in a stormwater system, the –
      - (aa) the volume of runoff due to increased impermeable areas and lower surface frictions in the upstream developments; and
      - (bb) the effectiveness of the downstream detention dams,
- are no greater or decreased than it was before the development took place;

**“flood level”** means that level reached by flood waters resulting from a storm designated in terms of recognised engineering criteria as being of a frequency to be expected once in every 50 years, and **“flood line”** has a corresponding meaning;

**“floodplain”** means the land adjoining a watercourse which, in the opinion of the Municipality, is predisposed to inundation by floods up to the 100 year recurrence interval;

**“Municipality”** means the Stellenbosch Municipality established by Provincial Notice No. 489 479 of 2000 in *Provincial Gazette* 5590 of 22 September 2000 as amended from time to time, or its successors in title; and includes any –

- (a) political structure;
- (b) political office bearer;
- (c) Councillor; and
- (d) duly authorised agent, service provider or any employee thereof, acting as contemplated in this By-law by virtue of a power vested in the Municipality and so authorised, delegated or sub-delegated to such –
  - (i) political structure;
  - (ii) political office bearer;
  - (iii) councillor;
  - (iv) agent;
  - (v) service provider; or
  - (v) employee;

**“municipal area”** means the area of jurisdiction of the Municipality as determined in terms of the Local Government: Municipal Demarcation Act, 1998 (Act 27 of 1998);

**“municipal manager”** means a person appointed in terms of section 82 of the Local Government: Municipal Structures Act, 1998 (Act 117 of 1998);

**“Municipal Systems Act”** means the Local Government: Municipal Systems Act, 2000 (Act 32 of 2000);

**“non-structural measures”** refer to planning, institutional and pollution prevention practices designed to –

- (a) prevent or minimize pollutants from entering stormwater runoff; and
- (b) reduce the volume of stormwater requiring management;

**“norms and standards”** refer to –

- (a) guidelines about how role players should act within the given context; and
- (b) minimum standards set to ensure that services are rendered in a specific, planned and effective manner,

as adopted and amended from time to time by the Municipality, and subsequently published within 30 days of the date of adoption;

**“organ of state”** bears the meaning assigned to it in section 239 of the Constitution of the Republic of South Africa, 1996;

**“owner”** includes any of the following:

- (a) the person in whom is vested the legal title to the premises, lessee, resident, director of a company, member of a close corporation, the person in control of any premises;
- (b) any person who obtains a benefit from the premises or is entitled thereto; and
- (c) the person administering an estate as curator, executor, proxy, trustee or administrator of a person in whom the legal title in immovable property is vested and who is insolvent, dead or of unsound mind;

**“person”** includes –

- (a) any divisional council, municipal council, village management board, or like authority; any organ of state;
- (b) any company incorporated or registered as such under any law; and
- (c) any body of persons corporate or unincorporate;

**“pollute”** means the direct or indirect alteration of the physical, chemical or biological properties of a water resource to cause it to be –

- (a) less fit for any beneficial purpose for which it may reasonably be expected to be used; or
- (b) harmful or potentially harmful to –
  - (i) the welfare, health or safety of human beings;
  - (ii) any aquatic or non-aquatic organisms;
  - (iii) the resource quality; or
  - (iv) property;

**“publish”** means to be announced by the Municipality for public notification by means of a Notice in the *Provincial Gazette*;

**“prescribed”** means –

- (a) a particular resolution of the Council; and
  - (b) in relation to –
    - (i) a fee, the cost as set out in the tariff policy of the Municipality;
    - (ii) an application for approval, the documents and procedures determined by the Municipality in a specific instance;
- as determined from time to time;

**“private stormwater system”** means a stormwater system owned, operated or maintained by a person other than the Municipality;

**“prior written permission of the Municipality”** means permission granted by the Municipality in accordance with section 4 of this By-law;

**“receiving waters”** refer to natural or man-made aquatic systems which receive stormwater runoff and includes, but is not limited to, watercourses, wetlands, canals, estuaries, and groundwater;

**“stormwater”** means water resulting from natural precipitation or the accumulation thereof, and includes –

- (a) groundwater; and
- (b) spring water

ordinarily conveyed by the stormwater system, but excludes water in a drinking water or waste water reticulation system;

**“stormwater policy”** means a policy document for the management of stormwater impacts, related activities and incidental matters, as adopted and amended from time to time by the Municipality, and subsequently published within 30 days of the date of adoption;

**“stormwater system”** means both the constructed and natural facilities, including pipes, culverts, watercourses and their associated floodplains, whether over or under public or privately owned land, used or required for the management, collection, conveyance, temporary storage, control, monitoring, treatment, use and disposal of stormwater;

**“structural measures”** refer to permanent engineered devices implemented to –

- (a) prevent or minimize pollutants from entering stormwater runoff; and
- (b) reduce the volume of stormwater requiring management;

**“water pollution incident”** means an incident or occurrence whereby a substance or matter, other than stormwater, ends up in the stormwater system and which may have a direct or indirect detrimental, or potentially detrimental, impact on the quality of the water in that system, to such an extent that public health or the health of natural ecosystems may be threatened;

**“watercourse”** means –

- (a) a river, spring, stream, channel or canal in which water flows regularly or intermittently;
- and

(b) a vlei, wetland, dam or lake into which or from which water flows, and includes, where relevant, the bed and the banks of such watercourses;

**“Water Sensitive Urban Design”** refers to an approach to ensure that development in urban areas is holistically planned, designed, constructed and maintained to –

(a) reduce negative impacts on the natural water cycle; and

(b) protect aquatic ecosystems,

and includes, but is not limited to, sustainable water supply, sanitation and stormwater management;

**“water source”** includes any water way, surface water, estuary or aquifer; and

**“wetland”** means land which is transitional between terrestrial and aquatic systems where the –

(a) water table is usually at or near the surface, or

(b) land, which in normal circumstances supports or would support vegetation typically adapted to life in saturated soil, is periodically covered with shallow water, and includes, but is not limited to, water bodies such as lakes, salt marches, estuaries, marshes, swamps, vleis, pools, ponds, pans and artificial impoundments.

**2. Aim, application and scope.** –(1) The provisions of this By-law aim to –

(a) reduce the impact of flooding on community livelihoods and regional communities;

(b) safeguard human health;

(c) protect natural aquatic environments; and

(d) maintain recreational water quality.

(2) This By-law binds all persons and organs of state.

(3) This By-law applies to stormwater systems in built-up areas and the natural environment on which it may have an impact, including but not limited to, any land use, development or activity proposals within the municipal area, draining to any watercourse or wetland.

(4) Any provision dealing specifically with stormwater in any other By-law, is subject to the provisions of this By-law: Provided that this By-law does not apply to other aspects of stormwater management such as protection of property and community health and safety.

(5) The provisions of this By-law do not eradicate the need for any other permit, consent or authorisation required under any other law.

(6) The provisions of this By-law must be read together with the –

(a) National Building Regulations and Building Standards Act, 1977 (Act 103 of 1977);

(b) Conservation of Agricultural Resources Act, 1983 (Act 43 of 1983);

(c) National Water Act, 1998 (Act 36 of 1998);

(d) National Environmental Management Act 1998 (Act 107 of 1998);

(e) Disaster Management Act 2002 (Act 57 of 2002);

(f) National Environmental Management: Biodiversity Act, 2004 (Act 10 of 2004);

- (g) Western Cape Planning and Development Act, 1999 (Act 7 of 1999); and
- (h) all of the following –
  - (aa) Municipal Code of By-laws;
  - (bb) Land Use Planning By-law of 2015 of the Municipality;
  - (cc) Zoning Scheme By-law 2019 of the Municipality;
  - (dd) Management of Urban Stormwater Impacts Policy of the Municipality;
  - (ee) Municipal Disaster Management Plan of the Municipality; and
  - (ff) other relevant Frameworks, Guides, Norms and Standards,
 as adopted and published,

where applicable.

- (7) In the event that –
  - (a) any provision in this By-law; or
  - (b) any stipulation in any of the documents contemplated in section 2 (6) (h) (bb) – (ff), no longer conforms to a Notice published in terms of applicable National or Provincial legislation after the date of commencement of this By-law, such Notice applies to the extent reasonably required until this By-law or such document has been updated accordingly.

- (8) This By-law and all the documents contemplated in section 2 (6) (h) (bb) – (ff) must be published on the website of the Municipality within 14 days of the date of publication of this By-law in the *Provincial Gazette*.

**3. Stormwater policies and guidelines.** –(1) The Municipality must develop, adopt, publish on its website and implement its stormwater policies and may amend those policies from time to time, as and when required.

- (2) The stormwater policies of the Municipality must –
  - (a) incorporate Water Sensitive Urban Design Principles into urban development;
  - (b) be based on Best Management Practices; and
  - (c) be aligned with other sustainability programmes of the Municipality.
- (3) The Municipality may limit the application of any stormwater policy to specific, or categories of, –
  - (a) areas;
  - (b) development premises; or
  - (c) activities,
 and may, on reasonable grounds, permit deviation or relaxation of, or exemptions from, any provisions of such policy.
- (4) Any person who –
  - (a) contravenes the provisions of a stormwater policy to the extent that same had been adopted in terms of this or any other By-Law of the Municipality; or
  - (b) furnishes false or misleading information required in terms of a stormwater policy, is guilty of an offence, and on conviction may be liable to a fine or imprisonment, or both such fine and imprisonment.

- (5) Stormwater policies must be made public and conveyed to the community in terms of section 21A of the Municipal Systems Act.
- (6) Notwithstanding subsections (1), (4) and (5), the Municipality may –
- (a) develop and approve guidelines that comply with the provisions of subsection (2) and (3); and
  - (b) implement such approved guidelines.
- (7) Any policy developed and adopted in terms of this section replaces the guidelines contemplated in subsection (6).
- 4. Applications for permits, consent or authorisation.** –(1) A person who wishes to obtain a permit, consent or authorisation of the Municipality as contemplated in this By-law, must submit an application in writing and in accordance with the applicable process as prescribed by the Municipality.
- (2) When considering an application contemplated in subsection (1), the Municipality may require the applicant to, at own cost, –
- (a) submit impact studies such as, but not limited to, environmental impact studies or environmental impact investigations as required in terms of national and provincial environmental legislation; and
  - (b) to establish and provide documentation indicating flood lines.
- (3) A permit, consent or authorisation may be granted by the Municipality subject to such conditions as determined by the Municipality after due consideration of the application.
- (4) Where a permit, consent or authorisation is required under this By-law and any other law enforced by the Municipality, such applications shall be lodged simultaneously.
- 5. Prohibited discharges.** –(1) No person may, except in accordance with the prior written permission of the Municipality, discharge, permit, cause or allow to enter or place onto any substance other than stormwater, where that substance could reasonably be expected, or is likely, to find its way into the stormwater system.
- (2) With the exception of rainwater, no person may permit, cause or allow any dirty, waste, swimming pool, infected or otherwise polluted water to flow from his premises into the stormwater system.
- 6. Measures to protect stormwater system.** –(1) Notwithstanding any other provision in this By-law, the Municipality may, in pertinent and lawful instances require from the owner of any private property (person A) to –
- (a) allow the owner of a higher lying property (person B), to, at such owner's cost (person B), lay a stormwater drainpipe or gutter over the owner's property (person A) to allow the draining of concentrated stormwater; or

- (b) retain stormwater on such property (of person A) or, at such owner's cost (person B), to lay a stormwater drain pipe or gutter to a suitable place indicated by the Municipality, irrespective of whether the course of the pipe or gutter will run over the owner's property (person A), or not.
- (2) No person may, except in accordance with the prior written permission of the Municipality –
- (a) adjust, alter, damage, endanger, destroy or undertake any action which may, or is likely to, damage, endanger or destroy, the stormwater system or the operation thereof;
  - (c) discharge, permit to enter or place anything likely to damage the stormwater system or interfere with the operation thereof or contaminate or pollute the water therein;
  - (d) construct or erect any structure or thing over or in such a position or in such a manner which may, or is likely to, interfere with, or endanger the stormwater system or the operation thereof;
  - (e) make an opening into a stormwater pipe, canal or culvert;
  - (f) drain, abstract or divert any water directly from the stormwater system; or
  - (g) fill, excavate, shape, landscape, open up or remove the ground above, within, under or immediately next to any part of the stormwater system.
- (3) No person may, except in accordance with the prior written permission of the Municipality, –
- (a) lead or discharge any water on, over or across; or
  - (b) by any means whatever, raise the level of water in any river, dam or watercourse to cause interference with or endanger, a street, sidewalk, pathway or public place.
- (4) No person may carry out, or create the risk of, any activity that causes, or may potentially cause, stormwater to flood the property of the municipality or that of any other person.
- (5) When an incident contemplated in section 5 and subsections (2), (3) or (4) of this section occurs without, or not in accordance with, the prior written permission of the Municipality, –
- (a) and the incident is not the result of natural causes, the person responsible for the incident; and
  - (b) the owner of the property on which the said incident occurred, or is occurring, must immediately report the incident to the Municipality: Provided that the person responsible for the incident or the owner of the property, as the case may be, must at own cost take all reasonable measures which, in the opinion of the Municipality, will contain and minimise the effects of the flooding, by undertaking cleaning up procedures, including the rehabilitation of the environment, as required by the Municipality.
- (6) A person who contravenes a provision of subsection (2), (3), or (4) commits an offence.
- (7) The Municipality may, subject to any laws which may be applicable and after obtaining consent of the owner and the occupier, if any, of the land concerned, –
- (a) deviate any watercourse, stream or river: Provided that the deviation is necessary for the protection of a public road or structure related to a public road or for the construction of a structure connected with or belonging to a street, sidewalk, pathway or public place;



- (b) divert stormwater from, or under, a street, sidewalk, pathway or public place onto private property other than land occupied by buildings, other structures or improvements; and
- (c) pay reasonable compensation as agreed between the owner or occupier and the Municipality, for any damage caused as a result of any action taken in terms of this subparagraph, or failing such agreement, compensation determined by arbitration in terms of the Arbitration Act, 1965 (Act 42 of 1965) or an alternative dispute resolution process.

**7. Sustainable urban drainage system.** –(1) In order to advance a holistic approach to catchment development and the application of Water Sensitive Urban Design Principles, all developers, owners, professionals and contractors must, at all times, comply with the following provisions:

- (a) Determine all floodlines which may impact on the development concerned, in which event the Municipality must, on written request, make available any floodline information that is on record;
  - (b) Do planning and take flood attenuation measures before any development above an existing development or in a catchment area commences;
  - (c) Make adequate provision for stormwater servitudes –
    - (i) where overland flow can occur, either naturally or as a result of the development; or
    - (ii) when the minor stormwater system infrastructure is overloaded or rendered ineffective due to a block up;
  - (d) Prevent concentration of stormwater runoff both spatially and in time wherever possible;
  - (e) Manage steep slopes and soil profiles, where they occur, before, during and after construction;
  - (f) Submit an application to the Municipality consisting of detailed plans to control and prevent erosion by water, prior to the commencement of any works, including site clearance on any portion of the site: Provided that the Municipality may grant such approval subject to such conditions as may be determined by the Municipality after due consideration of the application;
  - (g) Ensure that vegetation cover is removed with care and with attention to the potential erosion impact;
  - (h) Construct stormwater control systems before any construction on a site commences;
  - (i) Monitor and adjust the stormwater control measures taken during the construction progress, to ensure complete erosion control and appropriate runoff control;
  - (j) Keep earthworks on site to an absolute minimum;
  - (k) Design elements of developments so as not to impede the drainage process or cause a flood hazard by unsafely storing storm runoff on the property; and
  - (l) Avoid concentration of flow onto downstream properties due to walls and fences around properties that cross natural drainage channels.
- (2) In the event that it is impossible to avoid an increase in the downstream peak flow, the Municipality may only allow a development to proceed if it is satisfied that the downstream stormwater systems have the spare capacity to accommodate the additional peak flow.
- (3) The Municipality may, for stormwater control purposes, regularly and at all reasonable times enter any premises, or any portion thereof, to inspect the construction of buildings,

structures and earthworks in order to minimize risk or damages to properties and to determine the current status of a stormwater system.

- (4) In order to fulfil the function contemplated in subsection (1), the Municipality may –
- (a) declare areas as stormwater management areas in respect of which special requirements will apply regarding construction and earthworks of any activity and which, in the opinion of the Municipality, may reduce the risk of floods;
  - (b) require that the general plan or lay-out plans of the development or subdivision of any property, indicate lines in an acceptable form, to indicate the maximum level which will probably be reached by the flood water, in an average of 50 years and of 100 years;
  - (c) may, subject to other applicable legislation, refuse any –
    - (i) new permanent residential, commercial or industrial development;
    - (ii) request for densification; or
    - (iii) any other plans where the floodlines are not in line with the policy or guidelines contemplated in section 3:

Provided that where such development or application is approved within a flood plain, the lowest level of any new building, structure or addition thereto, must be above the floodlines as specified in the policy or guidelines as contemplated in section 3;
  - (d) determine that all services required by the development, be designed to withstand the –
    - (i) effects of flooding without risk of environmental pollution, or
    - (ii) risk of damage, injury or loss to the property owner, residents and general public;
  - (e) allow the construction of flood protection embankments: Provided that such embankment –
    - (i) does not materially affect the direction and velocity of the main stream or its tributary watercourses;
    - (ii) serves a useful purpose; and
    - (iii) does not increase the risks of damage to property or injury to any person.
- (5) All matters pertaining to sustainable urban drainage systems not provided for in this By-law, including but not limited to the following:
- (a) criteria for achieving Sustainable Urban Drainage Systems Objectives;
  - (b) interface with the Municipal Spatial Development Framework;
  - (c) incentive schemes; and
  - (d) monitoring and evaluation of adherence to Best Management Practices,
- must be addressed in stormwater policies of the Municipality.

**8. Stormwater management plan.** –(1) Where the submission of an approved stormwater management plan is a condition of approval as contemplated in section 7, the person responsible therefore must submit plans detailing the proposed stormwater control measures to the designated official: Provided that no physical work may commence without the prior written approval of the Municipality.

- (2) A stormwater management plan must describe and indicate –
- (a) the control measures to be implemented before and during the construction period;
  - (b) the final stormwater control measures required for the site on completion of site development;

- (c) the person responsible for the design of the control measures; and
- (d) who is, or will be, designated as the responsible person on site during each stage of the implementation of the control measures.

(3) If the approved stormwater management plan contemplated in subsections (1) and (2) is not adequately implemented or complied with, the owner or developer, as the case may be, is responsible to repair and restore all consequential environmental and other damages at his or her own cost.

**9. Stormwater systems on private land.** –(1) An owner of property on which private stormwater systems are located, –

- (a) may not carry out any activity which will, or which in the opinion of the Municipality could reasonably be expected to, impair the effective functioning of the stormwater system, and;
- (b) must, at own cost, keep such stormwater systems functioning effectively, including undertaking the refurbishment and reconstruction thereof if, in the opinion of the Municipality, it should be reconstructed or refurbished.

(2) The provisions of subsection (1) do not apply to the extent that the Municipality has accepted responsibility for any of such duties, either in –

- (a) accordance with a formal maintenance agreement; or
- (b) terms of a condition of a servitude.

(3)(a) If an immediate risk of flooding is identified, the Municipality may access the property concerned, irrespective of whether a servitude exists on that property or not, and without notifying the owner, to carry out the required works to prevent flood damage to upstream, surrounding or downstream properties.

(b) When accessing the property, the authorised employee must, on request, identify him or herself by producing written proof of such authority.

(c) The Municipality must immediately thereafter notify the owner concerned in writing of their liability to pay the costs of the carrying out of the required works as contemplated in paragraph (a).

**10. Provision of infrastructure.** –(1) The Municipality may –

- (a) construct, expand, alter, maintain or lay any drains, pipes or other structures related to the stormwater system on or under any immovable property, and ownership of these drains, pipes or structures shall vest in the municipality;
- (b) drain stormwater or discharge water from any municipal service works into any natural watercourse, and
- (c) do any other thing necessary or desirable for or incidental, supplementary or ancillary to any matter contemplated by subparagraph (a).

(2) When the Municipality exercises its powers in terms of subsection (1)(a) regarding immovable property not owned by the municipality, it must do so in compliance with the

provisions of the by-law of the Municipality relating to the management and administration of its immovable property.

**11. General powers.** –(1) The Municipality may –

- (a) demolish, alter or otherwise deal with any building, structure or other thing constructed, erected or laid in contravention of the provisions of this By-law;
- (b) fill in, remove and make good any ground excavated, removed or placed in contravention with the provisions of this By-law;
- (c) repair and make good any damage done in contravention of the provisions of this By-law or resulting from a contravention;
- (d) remove anything discharged, permitted to enter into the stormwater system or natural watercourse in contravention of the provisions of this By-law;
- (e) remove anything damaging, obstructing or endangering or likely to obstruct, endanger or destroy any part of the stormwater system;
- (f) seal off or block any point of discharge from any premises if such discharge point is in contravention of the provisions of this By-law; and
- (g) cancel any permit, consent or authorisation granted in terms of this By-law if the conditions under which such permit, consent or authorisation, the permission was granted are not complied with.

(2) The Municipality may, in any case where it seems that any action or neglect by any person or owner of property may lead to a contravention of the provisions of this By-law, give notice in writing to such person or owner of property to comply to such requirements as the Municipality may deem necessary to prevent the occurrence of such contravention.

(3) The Municipality may recover all reasonable costs incurred as a result of –

- (a) action taken in terms of subsection (1); or
  - (b) a contravention of any other provisions of this By-law,
- from a person who was responsible therefor or the owner of the property on which a contravention occurred.

**12. Appeal.** –(1) A person whose rights are affected by a decision of the Municipality in terms of this By-law, may appeal against the decision by giving written notice of the appeal and the reasons therefor in terms of section 62 of the Municipal Systems Act to the municipal manager within 21 days of the date of the notification of such decision.

(2) Upon receipt of the notice of appeal, the Municipality must proceed with the matter in accordance with the provisions of section 62 of the Municipal Systems Act.

**13. Exemptions.** –(1) Any person may, by means of a prior written application stating the reasons in full, apply to the Municipality for exemption from any provision of this By-law.

(2) The Municipality may –

- (a) approve such exemption in full or subject to reasonable conditions; or

- (b) refuse such exemption on reasonable grounds.
- (3) The Municipality may, on reasonable grounds, revise or cancel such exemption or conditions of an exemption.
- (4) Where applicable, an exemption does not take effect before the applicant has undertaken in writing to comply with all conditions imposed under subsection (2)(a).
- (5) In the event that –
  - (a) an activity for which exemption has been applied, commences before receipt of the undertaking contemplated in subsection (4) by the Municipality; or
  - (b) any condition of an exemption granted by the Municipality is not fully complied with, the exemption granted, lapses with immediate effect.

**14. Community liaison forums.** –(1) The Municipality may establish one or more community liaison forum for the purposes of furthering the stormwater activities of the municipality.

- (2) A community liaison forum may consist of –
  - (a) representatives of a group with a vested interest in the stormwater activities of the municipality;
  - (b) affected persons as contemplated in section 2 (4)(f) to (h) of the National Environmental Management Act, 1998 (Act 107 of 1998);
  - (c) designated officials of the municipality;
  - (d) a councillor; and
  - (e) any other persons as determined by the Municipality.
- (3) A community liaison forum contemplated in subsection (1) may, upon request of the Municipality or on its own initiative, submit input to the Municipality regarding any matter related to the implementation and application of this By-law.

**15. Offences and penalties.** –(1) Any person who –

- (a) contravenes any provision of this By-law;
- (b) fails to comply with the terms of any notice issued in terms of this By-law;
- (c) threatens, resists, hinders or obstructs or uses foul, abusive or insulting language towards or at a councillor or an employee or contractor of the Municipality in the exercise of any powers or performance of any duties or function in terms of this By-law, or falsely holds himself or herself to be a councillor, an employee or a contractor of the Municipality,

is guilty of an offence and liable, on conviction, for the payment of a fine.

**16. Repeal of By-laws.** –The By-laws listed in the Schedule hereto are hereby repealed to the extent indicated in the third column thereof.

**17. Short title and commencement.** –This By-law shall be known as the By-law relating to Stormwater and comes into operation on the date of publication thereof in the *Provincial Gazette*.

REVIEWED DRAFT V03 20200528

# **ANNEXURE B**

FAMILIEKENNISGEWINGS

IN MEMORIAM

GRIEBENAUW Jan

Die HOOGGERECHTSHOF VAN SUID-AFRIKA, WES-KAAPSE AFD. LING, KAAPSTAD, Sake nr. M15-2020, In die 9de parte aansoek van...

0705/1938-14/09/2020

12 jaar vandag sonder jou, Liefde en genade hou ons op die pad. Jy het inslusse in klein poppe bygekyk...

Jou vrou Marj (Pearl) Pretia, Helena, Gustav, Talina Dieter, Aelce, Helge, Marilouen, Ludwig en Emma.

PERSONEELKE DIENSTE

PERSONEEL

ALKOHOOLISTE Aansoek

SIENERS & Bids met probleme, liefde, finansies, saldi ens.

TE KOOP

REUSEL

ANNOAS, Plan en Beweels

NIKE OOP ARTIEKE MEUBELS

WOLWIEFERSKARE & BYKOMSTIGHEDE

DAMANT/GOLD, Veer u verkoop, onsekerheid vir reis.

VOLWASSENES

PRIVAAT

A REAMTLE BLACK DIAMOND

AFRIKAN DUST, UPMARKET

ALY TRAVELLERS

BRIGHTER BEHAAR

GEORGE MASENGA

Nicoel603 Strand 0619619194

YOUNG PERFORMERS

VAKANSIE & REIS

AKKOMMODASIE

PANDORA, 6, 021 701 8691

EIENDOME

WOONSTELLE TE HUUR

GODWOOD

1414 hertelingslaan met koming

Strand - 1/2 Mile, Makroon

APARTE INOANG

GODWOOD 2 Slaapkamers, 2 badkamers

BETREKKINGS

DRYVERS

PENSIONER TO DO SECURITY WORK

AVAIL

SMS TO 082 157 7629

Premier Industries Group BEVEL

Window Lite Trading (Pty) Ltd VOORLOPER LIKWIDASIEBEVEL

16/09/19 VERLORE AKTE

Die HOOGGERECHTSHOF VAN SUID-AFRIKA, WES-KAAPSE AFD. LING, KAAPSTAD, Sake nr. M15-2020, In die 9de parte aansoek van...

VERLORE DOKUMENTE

VERLORE VAN VERMIETDE TITELLEWIS

VERLORE AKTE

VERLORE AKTE

VERLORE AKTE

VERLORE AKTE

VERLORE AKTE

VERLORE AKTE

VERLORE AKTE

VERLORE AKTE

VERLORE AKTE

VERLORE AKTE

VERLORE AKTE

VERLORE AKTE

VERLORE AKTE

VERLORE AKTE

VERLORE AKTE

VERLORE AKTE

VERLORE AKTE

VERLORE AKTE

VERLORE AKTE

VERLORE AKTE

VERLORE AKTE

VERLORE AKTE

VERLORE AKTE

VERLORE AKTE

VERLORE AKTE

VERLORE AKTE

VERLORE AKTE

VERLORE AKTE

VERLORE AKTE

VERLORE AKTE

VERLORE AKTE

VERLORE AKTE

VERLORE AKTE

VERLORE AKTE

VERLORE AKTE

VERLORE AKTE

VERLORE AKTE

VERLORE AKTE

VERLORE AKTE

VERLORE AKTE

VERLORE AKTE

VERLORE AKTE

VERLORE AKTE

VERLORE AKTE

VERLORE AKTE

VERLORE AKTE

VERLORE AKTE

VERLORE AKTE

VERLORE AKTE

16/09/19 VERLORE AKTE

16/09/19 VERLORE AKTE

16/09/19 VERLORE AKTE

16/09/19 VERLORE AKTE

16/09/19 VERLORE AKTE

16/09/19 VERLORE AKTE

16/09/19 VERLORE AKTE

16/09/19 VERLORE AKTE

16/09/19 VERLORE AKTE

16/09/19 VERLORE AKTE

16/09/19 VERLORE AKTE

16/09/19 VERLORE AKTE

16/09/19 VERLORE AKTE

16/09/19 VERLORE AKTE

16/09/19 VERLORE AKTE

16/09/19 VERLORE AKTE

16/09/19 VERLORE AKTE

16/09/19 VERLORE AKTE

16/09/19 VERLORE AKTE

16/09/19 VERLORE AKTE

16/09/19 VERLORE AKTE

16/09/19 VERLORE AKTE

16/09/19 VERLORE AKTE

16/09/19 VERLORE AKTE

16/09/19 VERLORE AKTE

16/09/19 VERLORE AKTE

16/09/19 VERLORE AKTE

16/09/19 VERLORE AKTE

16/09/19 VERLORE AKTE

16/09/19 VERLORE AKTE

16/09/19 VERLORE AKTE

16/09/19 VERLORE AKTE

16/09/19 VERLORE AKTE

16/09/19 VERLORE AKTE

16/09/19 VERLORE AKTE

16/09/19 VERLORE AKTE

16/09/19 VERLORE AKTE

16/09/19 VERLORE AKTE

16/09/19 VERLORE AKTE

16/09/19 VERLORE AKTE

16/09/19 VERLORE AKTE

16/09/19 VERLORE AKTE

16/09/19 VERLORE AKTE

16/09/19 VERLORE AKTE

16/09/19 VERLORE AKTE

16/09/19 VERLORE AKTE

16/09/19 VERLORE AKTE

16/09/19 VERLORE AKTE

16/09/19 VERLORE AKTE

16/09/19 VERLORE AKTE

16/09/19 VERLORE AKTE

16/09/19 VERLORE AKTE

16/09/19 VERLORE AKTE

16/09/19 VERLORE AKTE

16/09/19 VERLORE AKTE

16/09/19 VERLORE AKTE

16/09/19 VERLORE AKTE

16/09/19 VERLORE AKTE

16/09/19 VERLORE AKTE

16/09/19 VERLORE AKTE

16/09/19 VERLORE AKTE

16/09/19 VERLORE AKTE

16/09/19 VERLORE AKTE

16/09/19 VERLORE AKTE

16/09/19 VERLORE AKTE

16/09/19 VERLORE AKTE

16/09/19 VERLORE AKTE

16/09/19 VERLORE AKTE

16/09/19 VERLORE AKTE

16/09/19 VERLORE AKTE

16/09/19 VERLORE AKTE

16/09/19 VERLORE AKTE

16/09/19 VERLORE AKTE

16/09/19 VERLORE AKTE

16/09/19 VERLORE AKTE

16/09/19 VERLORE AKTE

16/09/19 VERLORE AKTE

16/09/19 VERLORE AKTE

16/09/19 VERLORE AKTE

16/09/19 VERLORE AKTE

16/09/19 VERLORE AKTE

16/09/19 VERLORE AKTE

16/09/19 VERLORE AKTE

16/09/19 VERLORE AKTE

16/09/19 VERLORE AKTE

16/09/19 VERLORE AKTE

16/09/19 VERLORE AKTE

16/09/19 VERLORE AKTE

16/09/19 VERLORE AKTE

16/09/19 VERLORE AKTE

16/09/19 VERLORE AKTE

16/09/19 VERLORE AKTE

16/09/19 VERLORE AKTE

16/09/19 VERLORE AKTE

16/09/19 VERLORE AKTE

16/09/19 VERLORE AKTE

16/09/19 VERLORE AKTE

16/09/19 VERLORE AKTE

16/09/19 VERLORE AKTE

16/09/19 VERLORE AKTE

16/09/19 VERLORE AKTE

16/09/19 VERLORE AKTE

16/09/19 VERLORE AKTE

16/09/19 VERLORE AKTE

16/09/19 VERLORE AKTE

16/09/19 VERLORE AKTE

16/09/19 VERLORE AKTE

16/09/19 VERLORE AKTE

16/09/19 VERLORE AKTE

16/09/19 VERLORE AKTE

16/09/19 VERLORE AKTE

16/09/19 VERLORE AKTE

16/09/19 VERLORE AKTE

16/09/19 VERLORE AKTE

16/09/19 VERLORE AKTE

16/09/19 VERLORE AKTE

16/09/19 VERLORE AKTE

16/09/19 VERLORE AKTE

16/09/19 VERLORE AKTE

16/09/19 VERLORE AKTE

16/09/19 VERLORE AKTE

16/09/19 VERLORE AKTE

16/09/19 VERLORE AKTE

16/09/19 VERLORE AKTE

16/09/19 VERLORE AKTE

16/09/19 VERLORE AKTE

16/09/19 VERLORE AKTE

16/09/19 VERLORE AKTE

16/09/19 VERLORE AKTE

16/09/19 VERLORE AKTE

16/09/19 VERLORE AKTE

16/09/19 VERLORE AKTE

16/09/19 VERLORE AKTE

16/09/19 VERLORE AKTE

16/09/19 VERLORE AKTE

16/09/19 VERLORE AKTE

16/09/19 VERLORE AKTE

16/09/19 VERLORE AKTE

16/09/19 VERLORE AKTE

16/09/19 VERLORE AKTE

16/09/19 VERLORE AKTE

16/09/19 VERLORE AKTE

16/09/19 VERLORE AKTE

16/09/19 VERLORE AKTE

16/09/19 VERLORE AKTE

16/09/19 VERLORE AKTE

16/09/19 VERLORE AKTE

16/09/19 VERLORE AKTE

16/09/19 VERLORE AKTE

16/09/19 VERLORE AKTE

16/09/19 VERLORE AKTE

16/09/19 VERLORE AKTE

16/09/19 VERLORE AKTE

16/09/19 VERLORE AKTE

16/09/19 VERLORE AKTE

16/09/19 VERLORE AKTE

16/09/19 VERLORE AKTE

16/09/19 VERLORE AKTE

16/09/19 VERLORE AKTE

16/09/19 VERLORE AKTE

16/09/19 VERLORE AKTE

16/09/19 VERLORE AKTE

16/09/19 VERLORE AKTE

16/09/19 VERLORE AKTE

16/09/19 VERLORE AKTE



ITEM NUMBER	LEGISLATIVE MANDATE	DESCRIPTION OF POWER OR FUNCTION	RESPONSIBILITY / DELEGATED FROM	DELEGATED TO	SUB-DELEGATED TO	CONDITIONS/LIMITATIONS/ INSTRUCTION TO ASSIST
Stormwater By-Law BY-LAW DATED July 2020						
SWM1	Stormwater By-Law 2020 S3	Develop Policies and Guidelines	Council			
SWM2	Stormwater By-Law 2020 S4	Issuing Permits, consent and Authorization	Municipal Manager	Director: Infrastructure Services	Senior Manager: Roads, Transport and Stormwater (RTS)	
SWM3	Stormwater By-Law 2020 S6(1)	Instituting measures to protect stormwater systems	Municipal Manager	Director: Infrastructure Services	Senior Manager: RTS	
SWM4	Stormwater By-Law 2020 S6(7)	Allow deviations from standard measures	Municipal Manager	Director: Infrastructure Services	Senior Manager: RTS	
SWM5	Stormwater By-Law 2020 S7(2)	Permitting any Development to proceed upon increasing downward stormwater flow	Municipal Manager	Director: Infrastructure Services	Senior Manager: RTS	
SWM6	Stormwater By-Law 2020 S8	Approving Stormwater Management Plans	Municipal Manager	Director: Infrastructure Services	Senior Manager: RTS	
SWM7	Stormwater By-Law 2020 S9	Instructing Land or Property Owners to implement Stormwater Management	Municipal Manager	Director: Infrastructure Services	Senior Manager: RTS	
SWM8	Stormwater By-Law 2020 S11	Instructing the demolishing of building or other structures to be removed	Municipal Manager	Director: Infrastructure Services	Senior Manager: RTS	
SWM9	Stormwater By-Law 2020 S13	Exempting certain requirements	Municipal Manager			
SWM10	Stormwater By-Law 2020 S14	Creating Community Liaison forums	Municipal Manager	Director: Infrastructure Services		

PB11	Parking By Law 2020 S17(1)	Granting of Municipal works parking permits	Director: Community & Protection Services	Senior Manager: Protection Services	Manager: Traffic & Law Enforcement Services	
PB12	Parking By Law 2020 S19(1)	Designating Disabled, Diplomatic corps, SAPS and other identified reserved parking areas	Director: Community & Protection Services	Senior Manager: Protection Services	Manager: Traffic & Law Enforcement Services	
PB13	Parking By Law 2020 S30(2)	Issue permits to effect monthly parking	Director: Community & Protection Services	Senior Manager: Protection Services	Manager: Traffic & Law Enforcement Services	
PB14	Parking By Law 2020 S30(2)	Determine parking fees for permits	Council			
PB15	Parking By Law 2020 S30(3)	Issue permits for official parking	Director: Community & Protection Services	Senior Manager: Protection Services	Manager: Traffic & Law Enforcement Services	
PB16	Parking By Law 2020 S30(4)	Approve the transfer of a permit	Director: Community & Protection Services	Senior Manager: Protection Services	Manager: Traffic & Law Enforcement Services	
PB17	Parking By Law 2020 S33(1)	Authorize the removal of an abandoned vehicle	Director: Community & Protection Services	Senior Manager: Protection Services	Manager: Traffic & Law Enforcement Services	
PB18	Parking By Law 2020 S40(1)	Approval of the cleaning of vehicles within a parking ground	Director: Infrastructure Services	Senior Manager: Transport, Roads, Stormwater Traffic Engineering	Manager: Roads & Stormwater	

PB19	Parking By Law 2020 \$42(1)	Approval of parking hours of a parking ground and classes of vehicles allowed to park on this ground	Director: Infrastructure Services	Senior Manager: Transport, Roads, Stormwater Traffic Engineering	Manager: Roads & Stormwater	
PB20	Parking By Law 2020 \$43(1)	Approve notices to reserve parking for municipal vehicles and municipal staff vehicles	Director: Community & Protection Services	Senior Manager: Protection Services	Manager: Traffic & Law Enforcement Services	
PB21	Parking By Law 2020 \$45(5)	Approval of parking for vehicles exceeding one day's parking time	Director: Community & Protection Services	Senior Manager: Protection Services	Manager: Traffic & Law Enforcement Services	
PB22	Parking By Law 2020 \$48(1)	Approval of Special parking spaces for taxis	Director: Infrastructure Services	Senior Manager: Transport, Roads, Stormwater Traffic Engineering	Manager: Roads & Stormwater	
PB23	Parking By Law 2020 \$61(1)	Approval of compliance notices and recovery costs	Council			

**STORMWATER BY-LAW (2020) OFFENCES AND FINES**

<b>Section Contravened</b>	<b>Description of Offence</b>	<b>Proposed Fine (1)</b>	<b>Approved Fine (2)</b>
3(4)	Contravenes regulations on Policies and Guidelines	R500	
5(1)	Unauthorised discharge of substances within the stormwater system	R1000	
6(6)	Contravening regulations on construction and management of stormwater assets	R2 000	

NAG = No Admission of Guilt fine allowed

<b>13.5</b>	<b>REQUEST FOR INTRODUCTION OF STELLENBOSCH MUNICIPALITY DRAFT BY-LAW ON INTEGRATED WASTE MANAGEMENT</b>
-------------	--

Collaborator No: 696777  
 IDP KPA Ref No: Good Governance and Compliance  
 Meeting Date: 05 November 2020 and 25 November 2020

**1. SUBJECT: REQUEST FOR INTRODUCTION OF STELLENBOSCH MUNICIPALITY DRAFT BY-LAW ON INTEGRATED WASTE MANAGEMENT**

**2. PURPOSE**

That Council adopts the By-Law on Integrated Waste Management as per Section 12 of the Municipal Systems Act, as amended.

**3. DELEGATED AUTHORITY**

Municipal Council, as per Section 12 of the Municipal Systems Act, as amended. However the Mayor may request the Portfolio Committee to render assistance in terms of Section 80 of the Local Government Municipal Structures Act, Act 117 of 1998, as amended.

**4. EXECUTIVE SUMMARY**

The By-Law (**ANNEXURE A**) gives effect to the rights contained in Section 24 of the Constitution, Schedules 4(B) & 5(B) supported by Section 11 of the Local Government Municipal Systems Act 200 (Act 32 of 2000), where, a Local Government may proclaimate By-Laws to govern the services that is delivered to the constituencies of the Republic of South Africa.

As the functions of Cleansing, Refuse Removal, Refuse Dumps and Solid Waste Disposal falls within the jurisdiction of the Municipality, the Council may define and regulate, activities and functions on any matters pertaining the above and abbreviated as Integrated Waste Management

The By-Law on Integrated Waste Management aims to promote a safe environment for the benefit of all within Waste management and to give effect to the right contained in section 24 of the Constitution of the Republic of South Africa, 1996 and to regulate

- the avoidance, minimisation, generation, collection, cleaning and disposal of waste; and
- matters related thereto.

Council has noted the draft By-law and that it would be circulated for public comment. The public commenting period was between 14 September 2020 until 14 October 2020 (**ANNEXURE B**). The public was notified with an advertisement that was placed in the media "Die Burger" and on the Municipal website. No comments or objections were received.

This report serves to request that the new Integrated Waste Management By-Law be adopted by Council and that it be published in the provincial gazette.

**5. RECOMMENDATIONS**

- (a) that the By-Law on Integrated Waste Management, attached as **ANNEXURE A**, be adopted as per Section 12(2) to 12(4) & 13 of the Municipal Systems Act, as amended; and
- (b) that the adopted By-Law be sent to Provincial Government to be published in the provincial gazette.

---

**6. DISCUSSION / CONTENTS****6.1 Background**

Stellenbosch Municipality's does not have a By-Law on Integrated Waste Management

The Directorate Infrastructure Service has created this new By-Law on Integrated Waste Management. Aspects of older ordinances and new legislation has also been incorporated into the draft By-Law. The By-Law also incorporates all the facets of Waste Management which includes:

- a. Waste Collections
- b. Waste Removal,
- c. Area Cleaning
- d. Waste Minimisation
- e. Refuse Dump Management.

**6.2 Discussion**

Since no previous By-Law existed for any part of Waste management, a By-Law was created afresh but utilising the following source documents:

- a. Model Integrated Waste Management By-law (Mr Hendricks)
- b. City of Cape Town: Integrated Waste Management By-law, 2009
- c. Optimization of Waste Management Collection Operations Draft Report
- d. Adjusted version of City of Cape Town: Integrated Waste Management By-law.

By-Laws and Policies were reviewed and assessed. Comparative reviews of a number of By-Laws, promulgated by other Municipalities (relating to Integrated Waste Management) were also carried out.

Comparative review of by-laws relating to IWM in other South African municipal jurisdictions to identify relevant subject matter to be was incorporated.

Optimization of Waste Management Collection Operations Draft Report was analysed, relevant sections incorporated, new sections drafted, and amendments made.

All of the above were correlated with the National Environmental Management: Waste Act (NEMWA), 2008 (Act 59 of 2008);

The By-Law was further aligned to section 152 of the Constitution, section 13 of Local Government: Municipal Systems Act 32 of 2000, Consumer Protection Act 68 of 2008, and other documents as provided.

Along with improving safety for all making use of the Integrated Waste Management Service, the By-Law defines and regulates functions and activities which are allowable, prohibits activities that are hazardous to users and damaging to Municipal infrastructure, and empowers the Municipality to act on infringements within the total Integrated Waste Management arena.

**6.3 Financial Implications**

None

**6.4 Legal Implications**

The new By-Law may reduce Municipal liabilities (third party claims) as it allows for more effective control of activities within Integrated Waste Management

Section 12 & 13 of the Municipal Systems Act

**“12. *Legislative procedures.*—(1) Only a member or committee of a municipal council may introduce a draft by-law in the council.**

- (2) *A by-law must be made by a decision taken by a municipal council—*
  - (a) *in accordance with the rules and orders of the council; and*
  - (b) *with a supporting vote of a majority of its members.*
- (3) *No by-law may be passed by a municipal council unless—*
  - (a) *all the members of the council have been given reasonable notice; and*
  - (b) *the proposed by-law has been published for public comment in a manner that allows the public an opportunity to make representations with regard to the proposed by-law.*
- (4) *Subsections (1) to (3) also apply when a municipal council incorporates by reference, as by-laws, provisions of—*
  - (a) *legislation passed by another legislative organ of state; or*
  - (b) *standard draft by-laws made in terms of section 14.*

**13. *Publication of by-laws.*—A by-law passed by a municipal council—**

- (a) *must be published promptly in the Provincial Gazette, and, when feasible, also in a local newspaper or in any other practical way to bring the contents of the by-law to the attention of the local community; and*
- (b) *takes effect when published or on a future date determined in or in terms of the by-law.”*

**6.5 Staff Implications**

None

**6.6 Previous / Relevant Council Resolutions:**

**37<sup>TH</sup> COUNCIL MEETING: 2020-08-24: ITEM 11.5.4**

**RESOLVED** (nem con)

- (a) that the content of this report be noted;
- (b) that the Draft By-Law on Integrated Waste Management, attached as **ANNEXURE A**, be accepted as per Section 12(1) of the Municipal Systems Act, as amended; and
- (c) that a Public Participation process be launched as per Section 12(3)(b) and Section 21 of the Municipal Systems Act.

**6.7 Risk Implications**

None

**RECOMMENDATIONS FROM INFRASTRUCTURE SERVICES COMMITTEE MEETING TO  
THE EXECUTIVE MAYOR: 2020-11-05: ITEM 5.1.5 (RECOMMENDATIONS TO COUNCIL)**

- (a) that the By-Law on Integrated Waste Management, attached as **ANNEXURE A**, be adopted as per Section 12(2) to 12(4) & 13 of the Municipal Systems Act, as amended;
- (b) that Council notes that a public participation process was followed and no comments or objections were received; and
- (c) that the adopted By-Law be sent to Provincial Government to be published in the provincial gazette.

**ANNEXURES**

Annexure A: By-Law on Integrated Waste Management.

Annexure B: Notice published in Die Burger 14 September 2020

**FOR FURTHER DETAILS CONTACT:**

<b>NAME</b>	Deon Louw
<b>POSITION</b>	<b>Director</b>
<b>DIRECTORATE</b>	<b>Infrastructure Services</b>
<b>CONTACT NUMBERS</b>	<b>021 808 8213</b>
<b>E-MAIL ADDRESS</b>	<b>Deon.louw@ Stellenbosch.gov.za</b>
<b>REPORT DATE</b>	



# **ANNEXURE A**

[STELLENBOSCH MUNICIPALITY.]

[DATE OF COMMENCEMENT: XXXXX.]

This By-Law

was published by *Provincial Gazette* No. \_\_\_\_ dated \_\_\_\_.

STELLENBOSCH MUNICIPALITY

BY-LAW RELATING TO INTEGRATED WASTE MANAGEMENT DRAFT  
APPROVED BY COUNCIL ON XXX

AND

PROMULGATED IN TERMS OF SECTION 11 OF THE LOCAL GOVERNMENT:  
MUNICIPAL SYSTEMS ACT, 2000 (ACT 32 OF 2000)

STELLENBOSCH MUNICIPALITY INTEGRATED WASTE MANAGEMENT DRAFT BY-LAW  
(2020)

To give effect to the right contained in section 24 of the Constitution of the Republic of South Africa, 1996 and to regulate —

- the avoidance, minimisation, generation, collection, cleaning and disposal of waste; and
- matters related thereto.

Under the provisions of sections 156 (2) of the Constitution of the Republic of South Africa, 1996, and section 11 of the Local Government: Municipal Systems Act, 2000 (Act 32 of 2000) the Stellenbosch Municipality enacts as follows:

**TABLE OF CONTENTS**

<b>Preamble</b>	<b>5</b>
<b>1. Definitions</b>	<b>5</b>
<b>2. Application and scope</b>	<b>12</b>
<b>3. Principles</b>	<b>12</b>
<b>4. Categorisation of waste</b>	<b>12</b>
<b>5. Obligations of waste generators</b>	<b>13</b>
<b>6. Excess and additional waste</b>	<b>13</b>
<b>7. Industrial waste</b>	<b>14</b>
<b>8. Garden waste</b>	<b>14</b>
<b>9. Building waste</b>	<b>14</b>
<b>10. Hazardous waste</b>	<b>16</b>
<b>11. Event waste</b>	<b>18</b>
<b>12. Organic waste</b>	<b>19</b>
<b>13. Bulky waste</b>	<b>19</b>
<b>14. Waste tyres</b>	<b>20</b>
<b>15. Priority waste</b>	<b>20</b>
<b>16. Abandoned articles</b>	<b>21</b>
<b>17. Emergencies requiring the management of waste</b>	<b>21</b>
<b>18. Obligations of waste managers</b>	<b>21</b>
<b>19. Waste management clubs</b>	<b>21</b>
<b>20. Integrated waste management plan</b>	<b>22</b>
<b>21. Exemptions from submitting an integrated waste management plan</b>	<b>23</b>
<b>22. Storage and receptacles for general waste</b>	<b>24</b>
<b>23. Storage, separation, recycling, re-use, sorting and recovery of waste</b>	<b>25</b>
<b>24. Prohibition on unauthorised disposal of waste</b>	<b>25</b>
<b>25. Prohibition on burning of waste</b>	<b>26</b>

<b>26. Prohibition on littering and dumping</b>	<b>26</b>
<b>27. Prohibition of nuisance</b>	<b>27</b>
<b>28. Licences</b>	<b>28</b>
<b>29. Service providers</b>	<b>28</b>
<b>30. Collection and transportation of general waste</b>	<b>28</b>
<b>31. Waste management, collection and removal services</b>	<b>28</b>
<b>32. Transporting waste for gain</b>	<b>29</b>
<b>33. Collection of unsuitable waste</b>	<b>29</b>
<b>34. Waste transfer facilities</b>	<b>29</b>
<b>35. Disposal of waste</b>	<b>29</b>
<b>36. Access to private property</b>	<b>30</b>
<b>37. Premises inaccessible for refuse collection</b>	<b>30</b>
<b>38. Directives</b>	<b>30</b>
<b>39. Compliance notices</b>	<b>31</b>
<b>40. Appeals</b>	<b>32</b>
<b>41. Duty to produce documents</b>	<b>32</b>
<b>42. Service of documents and process</b>	<b>32</b>
<b>43. Failure to comply</b>	<b>33</b>
<b>44. Offences</b>	<b>33</b>
<b>45. Penalties</b>	<b>35</b>
<b>46. Seizure and impounding of vehicles</b>	<b>35</b>
<b>47. Designation of certain officials</b>	<b>36</b>
<b>48. Delegations by waste management officer</b>	<b>36</b>
<b>49. Functions and powers of waste management officer</b>	<b>36</b>
<b>50. Functions of authorised municipal officials and waste disposal facility operators</b>	<b>36</b>
<b>51. Ownership of waste</b>	<b>37</b>
<b>52. Liability to pay tariffs</b>	<b>37</b>

<b>53. Exemptions</b>	<b>37</b>
<b>54. Limitation of liability</b>	<b>38</b>
<b>55. Amendments to waste removal services</b>	<b>38</b>
<b>56. Transitional provisions</b>	<b>38</b>
<b>57. Guidelines</b>	<b>38</b>
<b>58. Repeal of By-laws</b>	<b>38</b>
<b>59. Interpretation</b>	<b>38</b>
<b>60. Short title</b>	<b>39</b>
<b>SCHEDULE 1 REPEALED LAWS</b>	<b>39</b>

## PREAMBLE

WHEREAS the Municipality has under the Constitution legislative competence in respect of refuse removal, refuse dumps and solid waste disposal;

Whereas the Stellenbosch Municipality has an obligation to regulate and control waste management so as to ensure a safe, healthy and sustainable environment and to ensure that the rights of individuals are protected;

Whereas the Municipality wishes to reduce the generation and the environmental impact of waste to ensure that the socio-economic development, the health of the people within the Municipality's boundaries and the quality of environmental resources are not unduly adversely affected by waste;

Whereas the Municipality wants to ensure that all residents, organisations, institutions, businesses, visitors, tourists and government departments are able to access services from a legitimate waste management service provider; and

Whereas the Municipality wishes to regulate waste generation, cleaning, collection, separation, storage, processing, treatment, recycling, re-use and disposal of waste, including littering and illegal dumping and the regulation of facilities used for the management of waste, with the ultimate aim of avoiding or minimising the generation of waste.

BE IT ENACTED by the Municipality, as follows: —

**1. Definitions.** —In this By-law, words used in the singular includes the plural and vice versa, the English text shall prevail in the event of an inconsistency between the different texts, and, unless the context otherwise indicates, —

**“accredited service provider”** means a person or entity accredited by the Municipality in accordance with its guidelines published from time to time and who provides a waste management service in the municipal area and may include, but is not limited to waste managers, large and small business, entrepreneurs, community cooperatives, and venture learnerships;

**“building waste”** means waste produced through the construction, alteration, repair or demolition of any structure both manmade and natural, and —

- (a) includes rubble, earth, wood and rock that is displaced during any construction, alteration, repair or demolition; but
- (b) excludes garden waste and hazardous waste;

**“bulky waste”** means waste that by virtue of its mass, shape, size or quantity is inconvenient to remove by the routine door-to-door waste removal service provided by the Municipality or a service provider;

**“business waste”** means —

- (a) waste that emanates from premises that are used, whether lawfully or unlawfully mainly, for commercial, retail, wholesale, entertainment or government administration purposes; and
- (b) also includes waste generated by informal traders and residential premises where commercial activities are being conducted;

**“chemical waste”** includes discarded solid, liquid and gaseous chemicals;

**“Director”** means the Director responsible for solid waste management in the Municipality;

**“disposal”** means the burial, deposit, discharge, abandoning, dumping, placing or release of any waste into, or onto, any land;

**“dump”**—

- (a) includes the —
  - (i) disposal of waste in any manner other than one permitted by this By-law or any other law; and
  - (ii) without derogating from the generality of the foregoing, the —
    - (aa) deposit;
    - (bb) discharge;
    - (cc) spill; or
    - (dd) release
 of waste, whether the said waste is in a container or receptacle or not, in or at any place whether publicly or privately owned, including but not limited to vacant land, rivers, waterways, catchments, and sewage and storm water systems, but
- (b) excludes littering;

**“event waste”** means waste that originates from the activities related to an event that is held in the Municipality;

**“garden waste”** —

- (a) refers to —
  - (i) organic waste, including but not limited to, soil, grass cuttings, leaves and branches; and
  - (ii) any biodegradable material, which emanates from gardening, landscaping or other types of activities at residential, business or industrial properties; but
- (c) excludes waste products of animal origin;

**“general waste”** is a generic term for waste that, because of its composition and characteristics, does not pose an immediate risk to public health or the environment if managed properly, and includes residential waste, building waste, business waste, and any waste classified as non-hazardous waste in terms of national or provincial legislation;

**“genotoxic waste”** means highly hazardous waste —

- (a) that may have mutagenic, teratogenic or carcinogenic properties; and
- (b) includes certain cytostatic drugs as well as vomit, urine or faeces from patients treated with cytostatic drugs, chemicals and radioactive material;

**“Government Gazette”** means the Government Gazette of the Republic of South Africa;

**“hazardous waste”** means —

- (a) any waste that contains organic or inorganic elements or compounds that may, owing to the inherent physical, chemical or toxicological characteristics of that waste, have a detrimental impact on human health, the health of other living organisms and the environment; and
- (b) includes —
  - (i) health care risk waste; and
  - (ii) the hazardous substances, materials or objects within business waste, residue deposits and residue stockpiles;

**“health care risk waste”** means —

- (a) that portion of health care waste that is hazardous including infectious waste, pathological waste, sharp waste, pharmaceutical waste, genotoxic waste, chemical waste, waste with heavy metals, radioactive waste, and
- (b) any other health care waste that is defined as hazardous in terms of the Western Cape Health Care Waste Management Act, 2007 (Act 7 of 2007) read with applicable national legislation;

**“holder of waste”** means —

- (a) any person who imports, generates, stores, accumulates, transports, processes, treats, exports or disposes of waste; and
- (b) includes recyclers and scrap dealers;

**“industrial waste”** means waste emanated from the manufacturing, industrial, fabricating or operational processes on premises that are used wholly or mainly for —

- (a) industrial purposes;
- (b) agricultural activities;
- (c) mining activities; or
- (d) the operation of power stations;

**“infectious waste”** means waste that is suspected to contain pathogens in a sufficient concentration or quantity to cause disease in susceptible hosts, and includes —

- (a) cultures and stocks of infectious agents from laboratory work;
- (b) waste from surgery and autopsies on corpses with infectious diseases;
- (c) waste from infected patients in isolation wards;
- (d) waste that has been in contact with —
  - (i) infected patients undergoing haemodialysis,
  - (ii) infected animals from laboratories, sanitary waste materials and tissues including swabs; and

any other instruments or materials that have been in contact with infected persons or materials;

**“integrated waste management plan”** means an integrated waste management plan that is required by the Municipality in terms of this By-law or any other applicable legislation;

**“licenced waste disposal facility”** means any site or premise which is licenced by the Province of the Western Cape or the National Government and used for the accumulation of waste for the purpose of disposing of that waste at that site or on that premise;

**“litter”** means waste, excluding hazardous waste, that has been thrown, dropped, deposited, spilled or in any other way discarded somewhere other than in an assigned receptacle, and “littering” has a corresponding meaning;

**“minimisation”**, when used in relation to waste, means the avoidance of the amount and toxicity of waste that is generated and, in the event where waste is generated, the reduction of the amount and toxicity of waste that is disposed of;

**“Minister”** means a minister in the Province appointed as such by the Premier of the Province in accordance with the provisions of section 35 of the Constitution of the Western Cape, 1998 (Act 1 of 1998) read with section 125 of the Constitution of the Republic of South Africa, 1996;

**“municipal area”** means the area of jurisdiction of the Municipality as determined in terms of the Local Government: Municipal Demarcation Act, 1998 (Act 27 of 1998);



**“municipal manager”** means a person appointed in terms of section 82 of the Local Government: Municipal Structures Act, 1998 (Act 117 of 1998);

**“Municipal Systems Act”** means the Local Government: Municipal Systems Act, 2000 (Act 32 of 2000);

**“Municipality”** means the Stellenbosch Municipality established by Provincial Notice No. 489 of 2000 in *Provincial Gazette* 5590 of 22 September 2000 as amended from time to time, or its successors in title;

**“National Building Regulations”** refers to the regulations made in terms of section 17(1) of the National Building Regulations and Building Standards Act, 1977 (Act 107 of 1977) as published in Government Notice R2378 of 1990 in *Government Gazette* 12780 dated 12 October 1990;

**“National government”** means the national sphere of government as established by the Constitution of the Republic of South Africa, 1996, and “national” has a corresponding meaning;

**“National Minister”** means a minister in the national sphere of government appointed as such by the President of the Republic of Africa in accordance with section 85 of the Constitution of the Republic of South Africa, 1996;

**“NEM:WA”** means the National Environmental Management: Waste Act, 2008 (Act 59 of 2008);

**“nuisance”** means any damage, inconvenience or annoyance to a person caused by the improper generation, handling, management, storage, placement, collection, transport or disposal of waste, including littering;

**“organ of state”** has the meaning assigned to it in section 239 of the Constitution of the Republic of South Africa, 1996;

**“owner”** includes any of the following:

- (a) the person in whom is vested the legal title to the premises, lessee, resident, director of a company, member of a close corporation, the person in control of any premises;
- (b) any person who obtains a benefit from the premises or is entitled thereto; and
- (c) the person administering an estate as curator, executor, proxy, trustee or administrator of a person in whom the legal title in immovable property is vested and who is insolvent, dead or of unsound mind;

**“pathological waste”** includes all human and animal tissues, organs, body parts, foetuses, blood and bodily fluids;

**“peace officer”** has the meaning assigned to it in the Criminal Procedure Act, 1977 (Act 51 of 1977);

**“person”** has the meaning assigned to it in the Interpretation Act, 1957 (Act 33 of 1957), and includes any —

- (a) organ of state;
- (b) company incorporated or registered as such under any law; and
- (c) body of persons corporate or unincorporate;

**“pharmaceutical waste”** includes expired, unused, spilt and contaminated pharmaceutical products, drugs, vaccines and sera that are no longer required and that need to be disposed of appropriately;

**“pressurised container waste”** includes pressurised cylinders and cartridges used in health care facilities to store gases;

**“priority waste”** means a waste declared to be such –

- (a) in terms of section 14 of NEM:WA; and
- (b) by the Director in terms of this By-law, national or provincial legislation;

**“Provincial Gazette”** means the official gazette of the Western Cape Province contemplated in section 33(1) of the Constitution of the Western Cape, 1998 (Act 1 of 1998);

**“Province”** means the Province of the Western Cape as established by the Constitution of the Republic of South Africa, 1996, and “provincial” has a corresponding meaning;

**“public road”** has the meaning assigned to it in the National Road Traffic Act, 1996 (Act 93 of 1996);

**“radioactive waste”** includes —

- (a) solid, liquid and gaseous materials contaminated with radionuclides,
- (b) waste produced as a result of procedures such as —
  - (i) in vitro analysis of body tissue and fluid,
  - (ii) in vivo organ imaging and tumour localization; and
  - (iii) various investigative and therapeutic practices;

**“receptacle”** means a container approved by the Municipality and having the capacity for the temporary storage of waste;

**“recyclable materials”** means any material that can be converted into raw or another form of material that can be re-used to make new products or resources;

**“recycle”** means a process where waste is reclaimed for further use, which process involves the separation of waste from a waste stream for further use and the processing of that separated material as a product or raw material;

**“residential waste”** means waste, that emanates from premises used wholly or mainly for residential, educational, healthcare, sport or recreational purposes, and —

- (a) includes recyclable materials and non-recyclable material; and
- (b) excludes hazardous waste;

**“re-use”** means to utilise the whole, a portion of or a specific part of any substance, material or object from the waste stream for a similar or different purpose without changing the form or properties of such substance, material or object;

**“SANS”** means a South African National Standard, issued by the South African Bureau of Standards, in terms of applicable law;

**“sharp waste”** includes items that could cause cuts or puncture wounds and includes, but is not limited to, needles, hypodermic needles, scalpels and other blades, knives, infusion sets, saws, broken glass and nails, and the word “sharp” has a corresponding meaning;

**“storage”** means the accumulation of waste in a manner that does not constitute treatment or disposal of that waste;

**“Tariff Policy and Tariff By-Law”** means the Tariff Policy and Tariff By-Law adopted by the Council of the Municipality and published in the *Provincial Gazette* from time to time;

**“transit”** means the continuous passage from one municipal boundary of the Municipality to another such boundary of the Municipality without storage other than temporary storage incidental to transport;

**“treatment”** means any method, technique or process that is designed to —

- (a) change the physical, biological or chemical character or composition of waste; or
  - (b) remove, separate, concentrate or recover a hazardous or toxic component of waste; or
  - (c) destroy or reduce the toxicity of a waste,
- in order to minimise the impact of the waste on human health, the health of other living organisms, or the environment, prior to further use or disposal;

**“waste”—**

- (a) means any substance, material or object that is —
  - (i) unwanted, rejected, abandoned, discarded or disposed of; or
  - (ii) intended or required to be discarded or disposed of by the holder of that substance, material or object, whether or not such substance, material or object can be re-used, recycled or recovered; and includes all wastes as defined in Schedule 3 to NEM:WA; and
- (b) includes the following categories:
  - (i) building waste;
  - (ii) business waste;
  - (iii) bulky waste;
  - (iv) event waste;
  - (v) infectious waste;
  - (vi) garden waste;
  - (vii) general waste;
  - (viii) genotoxic waste;
  - (ix) hazardous waste;
  - (x) health care risk waste;
  - (xi) residential waste;
  - (xii) industrial waste;
  - (xiii) pressurised container waste;
  - (xiv) pathological waste;
  - (xv) pharmaceutical waste;
  - (xvi) radioactive waste;
  - (xvii) recyclable waste;
  - (xviii) residential waste;
  - (xix) waste with heavy metals;
  - (xx) all wastes as defined in the NEM:WA; and
  - (xxi) any other substance, material or object that is not included in the NEM:WA that the Minister, in accordance with section 69(1)(a) of NEM:WA, may define as a waste by Notice in the *Government Gazette*:

Provided that any waste, or portion thereof, contemplated in subparagraphs (a) and (b), ceases to be waste —

- (i) once an application for its re-use, recycling or recovery has been approved or, after such approval, once it is, or has been re-used, recycled or recovered;
- (ii) where approval is not required, once a waste is, or has been re-used, recycled or recovered;

- (iii) where the Minister has, in terms of section 74 of NEM:WA, exempted any waste, or a portion of waste, generated by a particular process from the definition of waste; or
- (iv) where the Minister has, in the prescribed manner, excluded any waste stream, or a portion of a waste stream, from the definition of waste;

**“waste generator” —**

- (a) means —
  - (i) a property owner;
  - (ii) a household;
  - (iii) an organisation; or
  - (iv) a business entity,
 the inhabitants, occupants or employees of which generate waste; and
- (b) includes sorters of waste such as —
  - (i) recycling or waste minimisation groups;
  - (ii) scrap dealers; and
  - (iii) buy-back centres;

**“waste management activity”** means any activity listed in Schedule 1 of NEM:WA or published by the Minister by notice in the *Government Gazette* in terms of section 19 of NEM:WA, and includes —

- (a) the importation and exportation of waste;
- (b) the generation of waste, including the undertaking of any activity or process that is likely to result in the generation of waste;
- (c) the accumulation and storage of waste;
- (d) the collection and handling of waste;
- (e) the reduction, re-use, recycling and recovery of waste;
- (f) the trading in waste;
- (g) the transportation of waste;
- (h) the transfer of waste;
- (i) the treatment of waste; and
- (j) the disposal of waste;

**“waste management club”** means a group of persons, typically residing in a high density residential or office building, or a multi-property cluster residential or business development, that has an agreement approved by the Director in terms of this By-law to minimise waste in exchange for a lower tariff according to an approved integrated waste management plan;

**“waste management hierarchy”** means a method of managing waste in the following order: avoidance, reduction, re-use, recycling, recovery, treatment and disposal;

**“waste management officer”** means the Director or an officer designated under section 58(1) of NEM:WA or designated by the Council of the Municipality;

**“waste management service”** means waste collection, treatment, recycling and disposal service;

**“waste manager”** means any person who re-uses, recycles, recovers, treats or disposes of waste and the words “to manage waste” has a similar meaning;

**“waste minimisation club”** means a group of persons, typically residing in a —

- (a) high density residential or office building; or
- (b) multi-property cluster residential or business development,

that have an agreement, approved by the Director in terms of this By-law, to minimise waste according to an integrated waste management plan, in exchange for a lower tariff;

“**waste stream**” means waste that is divisible into different types of waste, including building waste, business waste, bulky waste, residential waste, garden waste, hazardous waste, health care risk waste, industrial waste and recyclable waste;

“**waste transfer facility**” means a facility that is used to accumulate and temporarily store waste before it is transported to a recycling, treatment or waste disposal facility;

“**waste transporter**” means any person who conveys or transfers waste between —

- (a) the waste generator and a waste management facility; or
- (b) waste management facilities; and

“**waste with heavy metals**” includes mercury waste from thermometers, blood- pressure gauges, residues from dentistry, cadmium waste from discarded batteries, reinforced wood panels used in radiation proofing, and drugs containing arsenic.

**2. Application and scope.** — (1) In the event of conflict between this By-law and any other By-law of the Municipality dealing with waste management, this By-law must prevail.

(2) This By-law must be read with the applicable provisions of the NEM:WA.

(3) This By-law applies to all persons.

**3. Principles.** —(1) The principles contemplated in Chapter 1 of NEM:WA apply in all instances where this By-law applies.

(2) The waste management hierarchy must be applied in the implementation of this By-law.

(3) The application of this By-law must promote —

- (a) sustainable development and a healthy environment through the management of waste within the area of the Municipality; and
- (b) responsible citizenship by residents in the area of the Municipality to ensure sound waste management practices.

**4. Categorisation of waste.** —(1) Waste shall be categorised in accordance with the definitions of the various types of waste in this By-law.

(2) The decision of the Director in respect of the categorisation of waste is, subject to any other applicable law, final.

(3) Service categories for waste management, as provided for in the tariff policy of the Municipality, must be defined in the integrated waste management policy of the Municipality.

**5. Obligations of waste generators.** —(1) A person must manage any waste generated by —

- (a) his or her activities, or
- (b) the activities of persons working —
  - (i) in his or her employ; or

(ii) under his or her direction or control, in such a manner that the waste does not cause harm to human health, the health of other living organisms, or damage to the environment.

- (2) A waste generator must —
- (a) avoid the generation of waste, or where it cannot be avoided, minimise the toxicity and amounts of waste generated;
  - (b) re-use, recycle or recover waste where possible;
  - (c) separate waste with the aim to —
    - (i) minimise its impacts on the environment; and
    - (ii) store the recyclable waste separately from non-recyclable waste: Provided that industrial waste must be separated into liquids, components and materials that can be treated for recycling or re-use;
  - (d) manage waste in a manner that does not endanger health, the environment or create a nuisance;
  - (e) maintain suitable cleanliness and hygiene standards on their premises as prescribed by any law;
  - (f) pay tariffs and rates charged by the Municipality for waste removal services according to the Municipality's Tariff By-law.

(3) A waste generator must conclude a contract with the Municipality or an accredited service provider, to collect waste generated by him or her, for the standard fee in terms of the Tariff By-law, at least once a week according to the routes as published by the Municipality or the service provider from time to time: Provided that residential waste must be collected in the manner contemplated in section 31(2).

(4) A waste generator must, prior to collection by the Municipality or the accredited service provider —

- (a) store waste in the receptacles provided in accordance with the contract contemplated in subsection (3); or
- b) where a receptacle is not provided, store waste in plastic black bags.

(5) A waste generator must dispose of waste —

- (a) in accordance the contract contemplated in subsection (3); or
- (b) by delivering waste to a licenced waste disposal facility and ensuring that said waste is treated or disposed of in an environmentally sensitive manner at the facility.

**6. Excess and additional waste.**—(1) A waste generator may apply to the waste management officer for an additional container and shall be liable for the additional costs as per the Municipality's Tariff By-Law and Tariff Policy.

(2) In the event that the waste generated by a waste generator exceeds the volume that can be stored in the containers provided, the waste generator must arrange for the collection of additional containers.

(3) If no arrangement is made for collection of excess waste, the municipality may provide an additional container to the property and the cost thereof will be added to the property owner's municipal account.

(4) Where the owner of a formal dwelling has other structures on the property with persons living in these separate structures, the Municipality must allocate one container per household and the additional cost thereof will be added to the property owner's municipal account.

(5) The owner of the formal dwelling must sign an additional contract with the Municipality for collection as contemplated in subsection (4) and is liable for the charges levied in connection therewith.

(6) Any business disposing of waste, or an agent disposing of waste on behalf of such business, must provide a waste manifest to the waste management officer on request.

**7. Industrial waste.** —(1) A waste generator generating industrial waste must —

(a) conclude a contract with the Municipality or an accredited service provider for the collection and disposal of such waste to an appropriate licenced waste disposal facility —

(i) at least once per week; or

(ii) as determined by the waste management officer; and

(b) on request, provide proof of such contract to the waste management officer.

(2) Industrial waste, for purposes of subsection (1), refers to that part of industrial waste that is classified as non-hazardous waste in terms of national or provincial legislation.

(3) Industrial waste that is classified as hazardous waste, must be dealt with in accordance with the provisions of section 10 of this By-law.

**8. Garden waste.** —(1) Garden waste generated at properties being used mainly for residential purposes may be —

(a) composted on the property;

(b) stored in a compost heap or suitable bags as per the Municipality's requirements; and

(c) kept on the property until collection or taken to a licenced waste disposal facility.

(2) The Municipality may, from time to time —

(a) stipulate maximum quantities of garden waste to be collected in respect for rural and urban areas; and

(b) impose conditions regarding the disposal of garden waste over a specified mass, and for this purpose call upon a waste generator of garden waste to present a weighbridge ticket as proof of proper disposal of such garden waste.

**9. Building waste.** —(1) A building waste generator —

(a) may not mix building waste with residential waste to be collected by the Municipality in accordance with the waste collection day schedule;

(b) must ensure that the building waste is recycled or, where it cannot be recycled, is disposed of at a facility designated by the Municipality to receive building waste; and

(c) must ensure that —

(i) contaminated building waste is treated or disposed of in which event a fee may be applicable; and

(ii) any other building waste containing a hazardous or dangerous agent, is deposited at a licenced waste disposal facility for the treatment and disposal of such waste.

(2) The municipal manager may issue a directive to a building waste generator after receipt of the building plan concerned, during the construction of the building, or after the completion of such building, to —

(a) separate the waste for treatment, recycling or reuse;

(b) report monthly to the Municipality on the quantities of building or demolition waste —

(i) generated;

- (ii) disposed of at an authorised waste disposal facility;
  - (iii) separated for recycling and reuse; or
  - (c) record the details contemplated in paragraph (b) monthly on the municipal waste information system.
- (3) A person who applies for approval from the Municipality to undertake demolition work in terms of the National Building Regulations and Building Standards Act, 1977 (Act 107 of 1977) and the National Building Regulations, must submit an integrated demolition waste plan with the application.
- (4) An integrated demolition waste plan must —
- (a) include a detailed description of the proposed demolition process;
  - (b) entail detailed plans for maximising the recovery of reusable and recyclable waste;
  - (c) make provision for collection and disposal of the building and other waste;
  - (d) include provision for the storage of the waste on the property concerned: Provided that if such storage is intended to be on municipal property, a valid waste management license must be attached.
- (5) The Municipality may, by Notice in the *Provincial Gazette*, require that a person operating, or wishing to operate, a building waste removal service in the area of the Municipality must —
- (a) register with the Municipality before undertaking such work; and
  - (b) provide such information as is specified in the Notice or as the Municipality may reasonably require.
- (6) An application for registration to operate a building waste removal service must be in the format determined by the Municipality as published in the Notice contemplated in subsection (5).
- (7) The Municipality must, within 30 days of receipt of an application for registration contemplated in subsection (5), consider the application and either—
- (a) register the applicant and issue a registration certificate to the applicant stating —
    - (i) the name of the facility registered to operate as a building waste removal service;
    - (ii) the waste information registration number;
    - (iii) the type of waste handled by the facility;
    - (iv) the location of the facility; and
    - (v) the date of registration; or
  - (b) return the application for correction or any additional information it may require.
- (8) An application for registration which has been returned for correction must be amended and resubmitted by the applicant to the Municipality within 30 days after the date it was returned.
- (9) An application for registration that has been amended and resubmitted as contemplated in subsection (8) must be dealt with as contemplated in subsection (7)(a).
- (10) The Municipality may provide a municipal building waste removal service on payment of a tariff as per the Municipality's Tariff-By-Law and Tariff Policy.
- (11) A person who wishes to place an appropriate receptacle for the storage and collection or disposal of building waste on a public road must apply to the Municipality for written consent.
- (12) A receptacle contemplated in subsection (11) must be—



- (a) clearly marked with the name, address and telephone number of the person responsible for the receptacle;
- (b) fitted with reflecting chevrons or reflectors that clearly outline the front, sides and the back of the receptacle; and
- (c) covered at all times, except when receiving or being emptied of waste, so that no displacement of its contents can occur.

- (13) The owner of the facility where building rubble is disposed of must—
- (a) register on the national or provincial waste information system concerned;
  - (b) submit reports to the national or provincial waste information system concerned as required by national or provincial legislation;
  - (c) provide proof to the waste management officer of—
    - (i) the registration contemplated in paragraph (a); and
    - (ii) the submission of reports contemplated in paragraph (b).

(14) The building or demolition waste generator or the owner of the property on which building or demolition waste is generated and who disposes or stores such waste on municipal property without the required permit, may be fined.

(15) When a building control officer inspects a property where building works have been undertaken in order to determine whether it has been built in accordance with the approved plans, he or she must also determine whether all building or demolition waste has been disposed of in the prescribed manner.

- (16)(a) The building control officer contemplated in subsection (15) may not issue an occupancy certificate; and
- (b) the Municipality may not grant final approval that the building has been built in accordance with the approved plans, unless the owner of the property provides the building control officer with a waste manifest that proves that the full mass of the building or demolition waste was disposed of at a licenced waste disposal facility for that category of waste.

**10. Hazardous waste.** —(1) A hazardous waste generator, or a person who treats, transports or disposes of hazardous waste, or who intends to generate, treat, transport or dispose of hazardous waste in the municipal area must—

- (a) at all times be in possession of a valid waste management licence as required in terms of NEM:WA and provincial legislation;
- (b) comply with—
  - (i) licencing conditions as contemplated in paragraph (a); and
  - (ii) relevant provisions of NEM:WA and provincial legislation;
- (c) submit reports as required in terms of NEM:WA and provincial legislation; and
- (d) provide proof to the waste management officer of—
  - (i) the licence contemplated in paragraph (a); and
  - (ii) the submission of reports contemplated in paragraph (c).

(2) The Municipality may, by Notice in the *Provincial Gazette*, require that a hazardous waste generator, or a person who treats, transports or disposes of hazardous waste, or who intends to generate, treat, transport or dispose of hazardous waste in the municipal area must —

- (a) register with the Municipality before undertaking such work; and
- (b) provide such information as is specified in the Notice or as the Municipality may reasonably require.

- (3) An application for registration to generate, treat, transport or dispose of hazardous waste must be in the format determined by the Municipality as published in the Notice contemplated in subsection (2).
- (4) The Municipality must, within 30 days of receipt of an application for registration as contemplated in subsection (3), consider the application and either—
- (a) register the applicant and issue a registration certificate to the applicant stating the —
    - (i) name of the facility registered to generate, treat, transport or dispose of hazardous waste;
    - (ii) waste information registration number;
    - (iii) type of waste handled by the facility;
    - (iv) location of the facility; and
    - (v) date of registration; or
  - (b) return the application for correction or any additional information it may require.
- (5) An application for registration which has been returned for correction must be amended and resubmitted by the applicant to the Municipality within 30 days after the date it was returned.
- (6) An application for registration that has been amended and resubmitted as contemplated in subsection (5) must be dealt with as contemplated in subsection (4)(a).
- (7) A hazardous waste generator or the owner of the premises where hazardous waste is generated must contract with an accredited registered service provider to collect, treat, transport or dispose of such waste at a licenced hazardous waste disposal facility.
- (8) A hazardous waste generator must ensure that hazardous waste, except for hazardous waste that does not require classification in terms of national legislation, is classified in accordance with SANS 10234 and any other SANS that may be issued from time to time, within —
- (a) 180 days of its generation;
  - (b) 180 days from the date of commencement of this By-law; or
  - (c) the time frame specified in a notice delivered by the Municipality.
- (9) A hazardous waste generator may not hand over hazardous waste to a service provider unless it is accompanied by a declaration in which —
- (a) the content of the consignment is fully and accurately described;
  - (b) it is stated whether or not the hazardous waste requires classification in terms of subsection (8);
  - (c) if the waste requires classification, the details of its classification are included.
- (10) Accredited and registered service providers may not accept hazardous waste that is —
- (a) not accompanied by a declaration referred to in subsection (9); or
  - (b) required to be classified in terms of subsection (8) read with subsection (9)(b), and has not been classified as such.
- (11) For the purposes of subsections (8), (9) and (10), a document prepared in terms of national or provincial legislation is acceptable provided that it contains all the required information.
- (12) The Municipality may, from time to time, publish a list of additional hazardous waste that requires classification in terms of subsection (8) read with subsection (9)(b).

(13) A person transporting hazardous waste must ensure that the facility or place to which the hazardous waste is transported is authorised to accept such hazardous waste prior to off-loading the hazardous waste from the vehicle concerned.

(14) A person responsible for the transit of hazardous waste through the municipal area, must comply with the provisions of subsections (1)(a), (b) and (d)(i).

**11. Event waste.** —(1) Any person who —

(a) intends to organise a sporting, entertainment, cultural or religious event which is to take place on private or public property; or

(b) owns or controls premises at which a sporting, entertainment, cultural or religious event is to take place, including sports stadia and conference centres,

must, together with his or her application to the Municipality for approval to host such event, submit an integrated event waste management plan in respect of the clean-up, storage, collection, recycling and disposal of waste at, and after such event, to the waste management officer.

(2) The event waste management plan must —

(a) be submitted to the Municipality together with the event application contemplated in the Event Management By-law of the Municipality;

(b) identify the person responsible for the execution of the plan;

(c) identify the accredited service provider responsible to clean-up, collect, recycle, remove and dispose of the event waste;

(d) set out in detail the measures to be taken for the clean-up, collection, recycling, removal and disposal of the event waste;

(e) include costing information; and

(f) comply with any terms and conditions as may be determined by the Municipality.

(3) The organiser of the event may be required to pay a refundable deposit to be determined by the Municipality.

(4) A person contemplated in subsection (1) must contract with an accredited service provider for the collection, clean-up, recycling and disposal of the event waste to a licenced waste disposal facility and provide proof of agreement to the Municipality as part of its integrated waste management plan.

(5) The organiser of the event must, after the event, ensure that the event waste is disposed of at an authorised waste management facility and provide the Municipality with proof of the disposal or recycling of the waste concerned.

(6) If any event waste has not been cleaned up and collected after an event has been held, the municipal manager may issue a directive to the organiser of the event to remove the waste to an authorised waste disposal facility.

(7) If a directive is issued as contemplated in subsection (6) and—

(a) the organiser of the event fails to comply, or inadequately complies, with the directive;

(b) there is uncertainty regarding the identity or whereabouts of the organiser of the event or responsible person; or

(c) there is an immediate risk of danger to the public or detriment to the environment, the Municipality may take all reasonable measure necessary to clean up, collect, recycle, remove and dispose, as the case may be, of the event waste.

(8) Should the organiser of an event fail or neglect to obtain the services of an accredited service provider in terms of subsection (4) prior to the event in question, or fail to provide the Municipality with the integrated waste management plan, the waste management officer may arrange for the collection, clean-up, recycling and disposal of the waste, in which case subsection (9) also applies.

(9) The cost for the collection, clean-up, recycling and disposal of the waste is payable by the event organiser and may be recovered from the deposit paid, or in terms of the Municipality's Tariff By-law.

(10) The organiser of an event and any other person responsible for the event arrangements, will be jointly and severally accountable for the costs incurred by the Municipality following the measures contemplated in subsections (8) and (9).

**12. Organic waste.** —(1) The occupant of premises on which organic waste is generated —

- (a) may compost the waste on the premises, provided that the composting does not cause a nuisance or harm to human health or damage to the environment;
- (b) but not composted, must ensure that the waste is collected and treated or disposed of within a reasonable period after its generation.

(2) The municipal manager may issue a directive to —

- (a) an organic waste generator to —
  - (i) develop an integrated refuse management plan indicating measures to minimise and recover such waste; and
  - (ii) transport the waste to designated facilities for treatment or disposal; and
- (b) a transporter of garden waste or a person providing garden maintenance services to transport any garden waste to a facility designated by the Municipality for disposal.

(3) The Municipality or an accredited service provider may —

- (a) upon written request of the occupant of premises on which organic waste is generated; and
- (b) on payment of a tariff as per the Municipality's Tariff-By-Law and Tariff Policy, deliver an appropriate receptacle for the purpose of storing organic waste, in addition to any receptacle already provided by the Municipality for general waste.

**13. Bulky waste.** —(1) A bulky waste generator —

- (a) may not place the bulky waste with other waste that is to be collected by the Municipality in accordance with the waste collection day schedule; and
- (b) must ensure that the bulky waste is recycled or, when it cannot be recycled, disposed of at a facility designated by the Municipality to receive bulky waste.

(2) The Municipality or an accredited service provider may, on the request of the occupant of premises at which bulky waste is generated, remove bulky waste from those premises on payment of a tariff.

(3) The municipal manager may issue a directive to an accredited service provider that collects bulky waste to —

- (a) report monthly to the Municipality on the quantities of bulky waste —
  - (i) disposed of; and
  - (ii) separated for recycling; or

- (b) record the details contemplated in paragraph (a) monthly on the municipal waste information system.

**14. Waste tyres.** —(1) A person operating, or intending to operate as a tyre producer, tyre dealer, waste tyre collector, tyre stockpile owner or tyre recycling processor in the municipal area must —

- (a) at all times be in possession of a valid waste management licence as required in terms of NEM:WA and provincial legislation;
- (b) comply with—
  - (i) licencing conditions as contemplated in paragraph (a); and
  - (ii) relevant provisions of NEM:WA and provincial legislation;
- (c) submit reports as required in terms of NEM:WA and provincial legislation; and
- (d) provide proof to the waste management officer of—
  - (iii) the licence contemplated in paragraph (a); and
  - (iv) the submission of reports contemplated in paragraph (c).

(2) The Municipality may, by Notice in the *Provincial Gazette*, require a person operating, or intending to operate as a tyre producer, tyre dealer, waste tyre collector, tyre stockpile owner or tyre recycling processor to —

- (a) register with the Municipality before undertaking such work; and
- (b) provide the information —
  - (i) specified in the Notice; or
  - (ii) reasonably required by the Municipality.

(3) An application for registration contemplated in subsection (2)(a) must be in the format determined by the Municipality as published in the Notice contemplated in subsection (2).

(4) The Municipality must, within 30 days of receipt of an application contemplated in subsection (2), consider the application and either—

- (a) register the applicant and issue a registration certificate to the applicant stating the —
  - (i) name of the facility registered to operate as a tyre producer, tyre dealer, waste tyre collector, tyre stockpile owner or tyre recycling processor;
  - (ii) waste information registration number;
  - (iii) type of waste handled by the facility;
  - (iv) location of the facility; and
  - (v) date of registration; or
- (b) return the application for correction or any additional information it may require.

(5) An application for registration which has been returned for correction must be amended and resubmitted by the applicant to the Municipality within 30 days after the date it was returned.

(6) An application for registration that has been amended and resubmitted as contemplated in subsection (5) must be dealt with as contemplated in subsection (4)(a).

(7) The Municipality may, by Notice in the *Provincial Gazette*, require the public to dispose of waste tyres at facilities designated in the notice.

**15. Priority waste.** —(1) The Director may, in accordance with this By-law, categorise priority waste if —

- (a) it has been declared a priority waste in terms of other applicable legislation;

- (b) he or she reasonably believes that special measures are required in respect of the management of that waste, because it —
  - (i) poses a significant threat to health or the environment;
  - (ii) may persist in the environment; or
  - (iii) contains or could foster pathogens or communicable diseases.

(2) The Municipality may, from time to time, publish guidelines that may be necessary in respect of categorisation of waste.

**16. Abandoned articles.** —The Municipality may remove and dispose of any article it reasonably considers abandoned, considering the following factors:

- (a) the location of the article;
- (b) the length of time that the article has been at that location; and
- (c) the nature and condition of the article.

**17. Emergencies requiring the management of waste.** —(1) In the event of an emergency, the Director may —

- (a) call upon the owner of a property, or a waste generator on such property, to manage the waste involved within a stipulated period and to the Municipality's satisfaction;
- (b) arrange for management of an emergency, including the clearing and cleaning of debris and pollution effects and —
  - (ii) transporting; and
  - (iii) disposal,
 of the waste at a licenced waste disposal facility accredited for the specific type of waste generated;
- (c) arrange, manage and co-ordinate the rehabilitation and repair of any infrastructure, buildings, equipment or natural environment damaged in this process.

(2) The cost of such management, rehabilitation and repair, including all costs incurred in the utilisation of the Municipality's resources, equipment and materials is for the account of the person responsible for the emergency.

(3) If an emergency occurs due to an act of God, the Municipality will deal with such emergency in the manner permitted by the circumstances and available funding.

**18. Obligations of waste managers.** —Waste managers —

- (a) must ensure that they comply with the legislation applicable to the waste management activity that they are engaged in; and
- (b) may not mix or treat waste, if the mixing or treating thereof will reduce the potential for re-use, re-cycling or recovery of such waste.

**19. Waste management clubs.** —(1) Waste management clubs may apply to the Director for a special dispensation as an enhanced service associated with waste minimisation in terms of the Municipality's Tariff By-Law and Tariff Policy.

(2) The waste management club must submit an integrated waste management plan in writing to the Director for approval, as well as other application documentation for the formation and operation of a waste minimisation club, as may be determined by the Municipality.

(3) The Director may, subject to the provisions of this By-law, determine whether to approve the application for a special dispensation of a waste minimisation club.

(4) If an application to form a waste minimisation club is —

- (a) unsuccessful, the Director must, within a reasonable time and in writing, provide reasons for turning down an approval to the waste minimisation club; and
- (b) approved by the Director, the club must comply with the terms and conditions set out by the Director for the generation, minimisation, storage, collection and disposal of such waste.

**20. Integrated waste management plan.** —(1) The waste generators named in subsection (12) must submit an integrated waste management plan in writing to the waste management officer for approval prior to the generation of the waste to be dealt with in terms of the said plan.

(2) An integrated waste management plan must include the following:

- (a) an assessment of the quantity and type of waste that will be generated;
- (b) a description of the services required to store, collect, transport and dispose of such waste;
- (c) a description of how separation of recyclable and non-recyclable material at the point of source will be done;
- (d) the waste minimisation and pollution prevention plans of such waste generator;
- (e) targets for waste minimisation through waste reduction, reuse, recycling and recovery;
- (f) measures to prevent pollution or ecological degradation;
- (g) the impact or potential impact on the environment of the waste created;
- (h) the type or characteristics of waste of an environmentally sensitive nature to be produced;
- (i) the amount of natural resources that are consumed in the manufacturing or production process that result in waste;
- (j) targets for waste production through waste minimisation, re-use, recycling;
- (k) recovery measures or programmes that can minimise the consumption of natural resources and the method of disposal of waste;
- (l) the timeframes of the implementation of the plan; and
- (m) methods for monitoring and reporting on the implementation of the plan.

(3) Every integrated waste management plan must comply with applicable additional requirements, if any, as set out in sections 7, 9, 10, 11, 14 and 15, respectively.

(4) An integrated waste management plan for industrial entities must include —

- (a) measures or actions to be taken to manage waste;
- (b) the phasing out of the use of certain substances; and
- (c) opportunities for reduction of waste generation through changes to packaging, product design or production processes.

(5) Industrial and business entities must provide for mechanisms to inform the public of the impact of waste-generating products or packaging on the environment through education, marketing and sales information, in order to influence perception and behaviour of customers to ensure recycling of products.

(6) When a waste generator is requested to submit an integrated waste management plan or a further integrated waste management plan in terms of this By-law, he or she must do so within the time stipulated and comply with the terms and conditions for the generation,

minimisation, storage, collection and disposal of such waste, as set out by the waste management officer.

- (7) The waste management officer must consider the plan and —
- (a) approve it with conditions and give directions for the implementation thereof;
  - (b) request that additional information be furnished or a revised plan be submitted for approval;
  - (c) require amendments to be made within a time frame so specified by them; or
  - (d) reject the plan and provide written reasons therefor.

(8) If an integrated waste management plan is rejected or not submitted at all, the municipal manager must issue directives to the waste generator as to what waste management measures he or she must take.

(9) If a waste generator fails to take the waste management measures contemplated in subsection (8) within the time frame specified by the municipal manager, the Municipality may implement such measures and the waste generator will be liable for the cost thereof.

- (10) The waste management officer may, by written notice, require waste generators to —
- (a) take reasonable steps to ensure that he or she —
    - (i) implements the integrated waste management plan;
    - (ii) complies with the directives given by the municipal manager; and
  - (b) report any non-compliance with any —
    - (i) applicable waste management plan; or
    - (ii) directive,
 to the waste management officer.

- (11) The Director may —
- (a) by written notice require any person to provide such information as he or she requires when preparing the Municipality's integrated waste management plan; and
  - (b) if that person fails to provide the information referred to in paragraph (a), appoint an auditor to obtain such information at the cost of the relevant waste generator.

- (12) The following persons must submit an integrated waste management plan:
- (a) waste generators of —
    - (i) business waste;
    - (ii) industrial waste;
    - (iii) building waste;
    - (iv) event waste;
    - (v) priority waste; and
    - (vi) hazardous waste, and
  - (b) every person who —
    - (i) applies for special dispensation in terms of section 19;
    - (ii) sorts waste or undertake a recycling, a re-use or a waste recovery activity, including but not limited to, scrap dealers, formalised recycling groups and buy back centres, which must register for accreditation with the Municipality, in order to entitle them to perform such activities; or
    - (iii) is given notice to do so by the Director;

**21. Exemptions from submitting an integrated waste management plan.** —(1) A waste generator of the categories of waste referred to in section 20(12)(b)(ii) who wishes to be exempt from submitting a waste management plan, may apply in writing for exemption to the waste management officer, stipulating reasons for the application.



- (2) A waste management officer may also declare—
- (a) certain types of waste or waste generators;
  - (b) a specified mass or volume of waste; or
  - (c) persons who have submitted such a plan to the other spheres of government in terms of their applicable legislation,
- to be exempt from the submission of an integrated waste management plan.

**22. Storage and receptacles for general waste.** —(1) A person who —

- (a) generates general waste to be collected by the Municipality; or
  - (b) separates waste streams to be collected by the Municipality for recycling,
- must place the waste in a receptacle approved, designated or provided for that purpose by the Municipality.

- (2) A person contemplated in subsection (1) must ensure that—

- (a) the receptacle is stored on the premises where the waste is generated and away from a public place between collection days;
- (b) the receptacle is placed outside the premises in an area accessible to municipal officials or service providers on the collection day determined in the waste collection day schedule;
- (c) measures are in place to prevent tampering with the receptacle by animals;

- (3) Any holder of waste who stores or transports waste must ensure that —

- (a) the container in which any waste is stored, is —
  - (i) intact;
  - (ii) not corroded or
  - (iii) in any other way rendered unfit for the safe storage or transportation of waste;
- (b) a receptacle provided by the Municipality is not used for any purpose other than for the storage of waste;
- (c) the waste is not stored at any public place;
- (d) suitable measures are in place to prevent accidental spillage or leakage of such waste;
- (e) the waste cannot be blown away;
- (f) nuisances such as odour, visual impacts and breeding of vectors do not arise;
- (g) pollution of the environment and harm to health are prevented;
- (h) hazardous waste is sealed in an impervious container and suitable measures are in place to prevent tampering; and
- (i) any waste items or substances are —
  - (i) safe for handling, collection or disposal; and
  - (ii) not harmful to persons when accessed by unauthorised persons or members of the public.

- (4) The waste generator and the holder of waste must ensure that waste is transported to the nearest licenced disposal facility that has capacity to deal with such waste.

- (5) A waste generator or the holder of waste must —

- (a) notify the Municipality if a receptacle contemplated in this section is stolen, damaged or corroded, as soon as the theft, damage or corrosion comes to his or her attention; and
- (b) arrange for the replacement of the said receptacle.

- (6) When a receptacle is stolen an authorised municipal official may request that the waste generator or holder of waste report the theft to the South African Police Service before issuing a new receptacle.

**23. Storage, separation, recycling, re-use, sorting and recovery of waste.** —(1) A person who undertakes any activity involving the reuse, recycling or recovery of waste, including —

- (a) scrap dealers,
- (b) buy back centres and
- (c) formalised recycling groups,

must, prior to undertaking that activity, ensure by way of an environmental impact assessment or a similar procedure required by national or provincial legislation, that the recycling, re-use or recovery of the waste is less harmful to the environment than its disposal.

(2) A person contemplated in subsection (1) must —

- (a) apply for accreditation from the Municipality in terms of its guidelines as published from time to time;
- (b) submit an integrated waste management plan for consideration and approval of the waste management officer;
- (c) register on the national or provincial waste information system concerned;
- (d) submit reports to the national or provincial waste information system concerned as required by national or provincial legislation; and
- (e) provide proof to the waste management officer of—
  - (i) the registration contemplated in paragraph (c); and
  - (ii) the submission of reports contemplated in paragraph (d).

(3) The waste management officer may exempt certain waste generators, handlers, transporters or agents of waste from such requirements.

(4) The municipal manager may issue a directive to a person contemplated in subsection (1) to —

- (a) report to the Municipality monthly on the quantities of waste —
  - (i) generated;
  - (ii) disposed of at an authorised waste disposal facility; and
  - (iii) separated for recycling and recovery; or
- (b) record the details contemplated in paragraph (a) monthly on the integrated pollutant and waste information system of the Municipality.

(5) The municipal manager may issue a directive to a holder of waste or the executive body of a community scheme and the owners and occupants of residential properties within a community scheme to require them to —

- (a) separate specified recyclable waste;
- (b) use different receptacles for different specified categories of recyclable waste; and
- (c) make recyclable waste available for collection in a specified manner.

(6) If the Municipality or an accredited service provider has provided separate receptacles for the purposes of subsection (5)(b), a person may not use any other receptacle for recyclable waste.

**24. Prohibition on unauthorised disposal of waste.** —(1) No person may —

- (a) dispose of waste other than in accordance with this By-law or National and Provincial legislation;
- (b) dispose of waste in or on any land or water body or at any facility unless the disposal of that waste is authorised by this By-law;

- (c) knowingly or negligently dispose waste, cause or permit waste to be disposed of, in a manner that is likely to —
  - (i) cause pollution,
  - (ii) cause harm to the health of humans or of other living organisms or
  - (iii) cause damage to the environment; or
  - (iv) otherwise negatively impact on the environment;
- (d) knowingly or negligently dispose hazardous waste, cause or permit hazardous waste to be disposed unless in —
  - (i) accordance with an approved waste integrated management plan; and
  - (ii) a container provided by the Municipality that is designed for the storage and disposal of hazardous waste;
- (e) burn waste, in particular hazardous waste, except —
  - (i) in an approved and licensed incinerator; and
  - (ii) by a person with a permit to operate and incinerator;
- (f) deposit in a public litter bin any waste that is not generated in a public place: Provided that no residential, business, industrial, garden, building or hazardous waste may be deposited in a public litter bin; or
- (g) deal with waste in a manner that causes dust, nuisance, spillage or litter.

(2) If waste has been disposed of in contravention of this By-law, the municipal manager may issue a directive to the person responsible for the contravention to remove the waste to an authorised waste disposal facility within a specified period.

(3) If a directive issued in terms of subsection (2) is not complied with, or inadequately complied with, and there is —

- (a) uncertainty regarding the identity or whereabouts of the person responsible; or
  - (b) an immediate risk of danger to the public or detriment to the environment,
- the Municipality may undertake all reasonable measures required to contain, minimise and remedy the effects of the illegally disposed waste, including clean-up procedures.

(4) Every person responsible for the unauthorised disposal of waste as contemplated in this section will be jointly and severally accountable for the costs incurred by the Municipality following the measures contemplated in subsection (3).

**25. Prohibition on burning of waste.** —No person may burn, incinerate or apply any other thermal treatment technology to waste except in a thermal treatment facility authorised by the Municipality or the relevant competent authority.

**26. Prohibition on littering and dumping.** —(1) No person may —

- (a) drop, throw, deposit, spill, dump, store or in any other way discard, any litter or waste into or onto any public place, municipal drain, land, vacant erf, stream, water course, street, road, wetland, coastline or on any place to which the public has access or onto any private property that is owned by a third party;
- (b) otherwise dispose of any litter or waste;
- (c) disturb anything in, or remove anything from, any receptacle that has been placed for the purposes of collecting waste in such a manner as to cause the contents of the receptacle to spill or fall onto the ground; or
- (d) allow a person under his or her employ, direction or control to do any of the acts contemplated in subsections (1)(a), (b) and (c).

(2)(a) The owner of private land to which the public has access must ensure that enough containers are provided to contain litter which is discarded by the public.

(b) If litter has been disposed of or discarded in contravention of this By-law on privately owned land to which the public has access, the owner of that land must remove the litter from the property within a reasonable period.

(3) A person who —

- (a) owns;
- (b) is in control of; or
- (c) has a right to use,

land or premises, may not use or permit the use of such land or premises for unlawful dumping of waste and must take reasonable steps to prevent the use of such land or premises for that purpose.

(4) In the event of a contravention of subsections (1), (2) or (3), the Director may issue a written notice to the offender, to —

- (a) cease the contravention within a specified time;
- (b) prevent a further contravention or continuation of the contravention;
- (c) take whatever measures the Director considers necessary to clean up or remove the waste;
- (d) rehabilitate the affected facets of the environment; and
- (e) ensure that the waste and any contaminated material which cannot be cleaned or rehabilitated is disposed of lawfully:

Provided that the Director may also require the offender to submit a plan for approval with timeframes for the removal of the litter or waste as contemplated in subsections (1)(a), (b) and (c) and the rehabilitation of the area concerned.

(5) In the case of non-compliance with subsection (4), the Municipality may elect to act to remove the litter or waste contemplated in this section, in which event the person concerned shall be liable for the cost of such removal operation.

(6) In the case of hazardous waste, the Municipality may immediately act to remove the litter or waste and immediately thereafter notify the person concerned of their liability to pay the costs of removal, rehabilitation and any other reasonably related costs within the stipulated time.

**27. Prohibition of nuisance.** —(1) A person handling waste, whether during storage, collection, transportation, recycling, treatment or disposal, must—

- (a) take reasonable measures to prevent it from being a nuisance to anybody or the environment; and
  - (b) take measures at his or her own cost to remedy any nuisance caused,
- and the municipal manager may issue a directive to such a person to ensure compliance with this section.

(2) If a directive contemplated in subsection (1) is issued and—

- (a) such a person fails to comply, or inadequately complies, with the directive;
  - (b) there is uncertainty regarding the identity or whereabouts of such a person; or
  - (c) there is an immediate risk of danger to the public or detriment to the environment,
- the Municipality may take any measure it considers necessary to prevent the nuisance, contain and minimise the effects of the nuisance and remedy its effects.

(3) Every person responsible for the nuisance contemplated in this section will be jointly and severally accountable for the costs incurred by the Municipality following the measures contemplated in subsection (2).

**28. Licences.** —The waste management officer may require that any person who, or entity which, requires a licence to handle waste in terms of national or provincial legislation, provide proof of the appropriate license within a period as stipulated by the waste management officer.

**29. Service providers.** —(1) The Municipality may discharge any of its functions pertaining to waste separation, collection, storage, processing, recycling, treatment and disposal by entering into a service delivery agreement with an accredited service provider.

(2) A service delivery agreement must —

- (a) accord with this By-law;
- (b) stipulate service standards for the services to be rendered, including collection times and frequency;
- (c) provide for the circumstances in which services rendered by the service provider may be limited;
- (d) require the service provider to be registered on the national or provincial waste information system; and
- (e) provide for reporting to the Municipality.

**30. Collection and transportation of general waste.** —(1) The Municipality must set a schedule of the days for the collection of waste and the location where waste receptacles must be placed on those days.

(2) The Municipality may —

- (a) set a different waste collection day schedule for commercial and residential properties;
- (b) collect waste outside of the set schedule on request and at a fixed tariff;
- (c) set the maximum quantities of waste that will be collected;
- (d) by Notice in the *Provincial Gazette*, identify waste streams that may not be collected by the Municipality or that are unsuitable for collection.

(3) The Municipality must—

- (a) publish the waste collection day schedule, in both printed form and electronically; and
- (b) take other reasonable measures to ensure that the public is notified of the schedule.

(4) If waste that is being transported is spilt, leaked or detached or falls from a receptacle, vehicle or other conveyance, the Municipality may recover costs from the transporter for reasonable remedial measures undertaken by the Municipality.

**31. Waste management, collection and removal services.** —(1) All persons collecting or removing waste must have a contract for the collection and removal of waste with the Municipality or an accredited service provider.

(2) Residents must apply and register for waste collection and removal services that will be provided exclusively by the Municipality or its contracted accredited service provider, unless the Council authorises otherwise.

(3) Businesses must contract with —

- (a) the Municipality; or
  - (b) an accredited service provider,
- for the waste collection and removal services.

- (4) Industries must contract with —
  - (a) in the case of general waste, contract with the Municipality or an accredited service provider; and
  - (b) in the case of hazardous waste, contract with an accredited service provider, for the waste collection and removal services.

(5) Commercial and industrial undertakings, including scrap dealers, who require a waste collection and removal service that is not provided by the Municipality, must register with the Municipality and prove that they have contracted with an accredited service provider for such service.

- (6) An entity providing waste management services, or an accredited service provider required to have a licence or approval in terms of national or provincial legislation, must —
  - (a) provide proof of such licence or approval; and
  - (b) comply with criteria determined by the Council, before they will be registered by the Director.

(7) The Director must keep an updated record of registered accredited service providers.

**32. Transporting waste for gain.** —A person transporting general waste for gain in the area of the Municipality must, at all times —

- (a) be accredited by the Municipality;
- (b) ensure that the receptacle, vehicle or other conveyance is adequate in size and designed for the type of waste transported;
- (c) transport the waste in a manner that will prevent any nuisance;
- (d) maintain the receptacle, vehicle or other conveyance in a clean and sanitary condition; and
- (e) ensure that the waste is transported to, or deposited at, a waste transfer facility, general waste storage facility, recycling facility or waste disposal facility authorised to accept such waste.

**33. Collection of unsuitable waste.** —A person may not place waste identified in terms of section 30(2)(d) to be unsuitable for collection, either on its own or mixed with any other waste for which the Municipality provides collection services.

**34. Waste transfer facilities.** —A waste generator must, where applicable—

- (a) use an appropriate waste transfer facility as instructed by an authorised municipal official, a waste disposal facility operator or a service provider; and
- (b) adhere to the operational procedures of the waste transfer facility as determined by the Municipality.

**35. Disposal of waste.** —(1) An authorised municipal official, waste disposal facility operator or service provider may inspect all waste loads entering a waste transfer facility, general waste storage facility, recycling facility or waste disposal facility.

(2) The inspection contemplated in subsection (1) may include the visual and physical inspection of the waste.

(3) An authorised municipal official may issue an instruction to the holder of waste that is potentially detrimental to the environment to—

- (a) have independent laboratory tests conducted before the waste is disposed of to assess whether the waste is suitable for a waste disposal facility; or
- (b) dispose of the waste at an appropriate waste disposal facility that is authorised to accept such waste and to provide proof of such disposal.

(4) If the holder of waste contemplated in subsection (3)(b) does not comply with the prescribed disposal, the Municipality may remove and dispose of such waste at an appropriate waste disposal facility.

(5) In the circumstances contemplated in subsections (3) and (4), or where waste contemplated in section 30(2)(d) is removed by the Municipality, every person responsible for that waste will be jointly and severally accountable for the costs incurred, including the costs associated with—

- (a) the use of specialised equipment during the laboratory tests;
- (b) laboratory analysis fees;
- (c) administrative fees;
- (d) transporting and disposal costs; and
- (e) clean-up costs, where applicable.

(6) A person disposing of waste at a waste disposal facility owned or managed by the Municipality must adhere to the operational procedures of the facility.

**36. Access to private property.** —(1) An owner of private property must, on request, allow a peace officer or any other duly authorised employee of the Municipality access to their property during reasonable hours for the purpose of inspecting the property and investigating any contravention of this By-law and to ensure compliance therewith.

(2) When accessing the property, the authorised employee must, on request, identify him or herself by producing written proof of such authority.

(3) Such employee may be accompanied by a person reasonably required to assist in the inspection or to conduct an investigation, who must be identified as such by the authorised employee.

**37. Premises inaccessible for refuse collection.** —If employees of the Municipality, or of an accredited service provider as contemplated in section 29, are—

- (a) impeded from handling or collecting waste at any premises due to the layout of the premises; or
- (b) endangered by an impediment on the premises when handling or collecting waste at any premises,

the municipal manager may issue a directive requiring the owner of the premises to undertake such alterations or additions to the premises as are necessary to remove the impediment at the owner's cost.

**38. Directives.** —(1) The municipal manager may issue a directive to any person contemplated in this By-law, to take specific measures pertaining to waste within a specified period to ensure that the impact of waste on human health or damage to the environment is mitigated and to give effect to the waste management hierarchy.

(2) Before issuing a directive contemplated in this By-law, the municipal manager must give notice in writing to the person to whom the directive is intended to be issued of the intention

to issue the directive, and give that person a reasonable opportunity to make representations in writing.

(3) If urgent action is necessary for the protection of the environment, or as contemplated in section 37, the municipal manager—

- (a) may issue the directive without giving written notice to the person beforehand; and
- (b) must give the person to whom the directive was issued an opportunity to make written representations within a reasonable period thereafter.

**39. Compliance notices.**—(1) An authorised municipal official may issue a written compliance notice to a person if there are reasonable grounds for believing that the person has not complied with a —

- (a) provision of; or
- (b) term or condition of any permit, authorisation, exemption or other document issued in terms of,

this By-law.

(2) Before issuing a compliance notice, an authorised municipal official must give notice in writing to the person to whom the compliance notice is intended to be issued of the intention to issue the compliance notice and provide that person with a reasonable opportunity to make written representations.

(3) If urgent action is necessary for the protection of the environment, an authorised municipal official —

- (a) may issue a compliance notice without giving written notice to the person beforehand; and
- (b) must give the person to whom the compliance notice was issued an opportunity to make written representations within a reasonable period thereafter.

(4) A compliance notice must set out —

- (a) details of the conduct constituting non-compliance;
- (b) any steps the person must take and the period within which the steps must be taken;
- (c) any actions the person may not perform, and the period during which the person may not do so;
- (d) the steps the Municipality is entitled to take in terms of subsection (6) if the notice is not complied with; and
- (e) the procedure to be followed to lodge an appeal against the compliance notice.

(5) An authorised municipal official may, on good cause shown, vary a compliance notice and extend the period within which it must be complied with.

(6) If a person to whom a compliance notice has been issued fails to comply with it, the Municipality may—

- (a) take whatever steps it considers necessary, where applicable, to—
  - (i) clean up or remove the waste;
  - (ii) rehabilitate the premises, place or affected area at which the waste has been dumped or disposed of or is stored; and
  - (iii) ensure that waste and any contaminated material that cannot be removed, cleaned or rehabilitated is treated or disposed of lawfully; and
- (b) recover the costs of any steps contemplated in paragraph (a) from every person responsible to take such steps in terms of this By-Law, who will be jointly and severally accountable for those costs.



(7) The Municipality may, in the case of hazardous or priority waste, require the persons generating such waste to close until such time as steps are taken to dispose of the waste as provided for in this By-law and any other applicable law, if there is a real threat of damage or injury to any person or property.

(8) The following persons may be served with a compliance notice:

- (a) any person who committed, or who directly or indirectly permitted, such contravention;
- (b) the generator of the waste;
- (c) the owner of the land or premises where the contravention took place;
- (d) the person in control of the land or premises where the contravention took place;
- (e) any person who has or had, at the stage of the contravention, a right to use the land or premises where the contravention took place; or
- (f) a service provider.

**40. Appeals.**—(1) A person whose rights are affected by a decision taken by the Municipality in terms of this By-law may, unless the decision was taken by the municipal council, appeal against that decision in terms of section 62 of the Municipal Systems Act.

(2) The appeal authority to consider the appeal will comprise of the person or body contemplated in section 62(4) of the Municipal Systems Act.

(3) Subject to subsections (4) and (5), an appeal under this section suspends the operation of the decision concerned pending the finalisation of the appeal.

(4) A person who receives a directive or compliance notice issued in terms of this By-law must comply with that directive or compliance notice within the period stated in the directive or compliance notice, unless the appeal authority has agreed to suspend the operation of the directive or compliance notice as contemplated in subsection (5)(b).

(5) The appeal authority may, on application and on good cause shown, direct that, pending the finalisation of the appeal—

- (a) the operation of the decision forming the subject of the appeal, or any provision or condition attached thereto, is not suspended, either wholly or in part; or
- (b) the operation of the directive or compliance notice contemplated in subsection (4), or any part of that directive or compliance notice, is suspended.

**41. Duty to produce documents.**—A person to whom a certificate, permit, authorisation or any other document contemplated in this By-law has been issued must produce it at the request of a peace officer or an authorised municipal official.

**42. Service of documents and process.**—Whenever any notice, order, demand or other document is authorised or required to be served on a person in terms of this By-law, it shall be deemed to have been effectively and sufficiently served on such a person—

- (a) when it has been delivered to him or her personally;
- (b) when it has been left at his or her place of residence or business with a person apparently over the age of 16 years;
- (c) when it has been posted by registered or certified mail to his or her last known residential or business address and an acknowledgement of posting thereof is produced;
- (d) if his or her address is unknown, when it has been served on his or her agent or representative in a manner provided for in paragraph (a), (b) or (c); or

- (e) if his or her address and agent are unknown, when it has been posted in a conspicuous place on the immovable property, if any, to which it relates.

**43. Failure to comply.** —(1) If the waste management officer has issued a compliance notice in terms of section 39 to anyone for contravening any provision of this By-law and such person fails to comply with such notice he or she is guilty of an offence.

(2) The waste management officer may, in writing, require any person to submit a report to him or her in respect of the impact of waste in the format stipulated in the Municipality's guidelines as published from time to time.

(3) If the person fails to submit such a report within the period specified, the waste management officer may appoint an independent person to compile the report and recover the costs of compiling the report from the person required to submit it.

(4) If the waste management officer suspects that —

(a) the person has on one or more occasion contravened, or failed to comply with, the By-law or a license issued in terms of provincial or national legislation; and

(b) this has —

(i) had a detrimental effect on the environment, including health, social conditions, economic conditions, ecological conditions or cultural heritage; or

(ii) contributed to the degradation of the environment,

the waste management officer may direct that such a report be compiled by an independent person.

(5) The waste management officer may then direct the person who failed to comply with the By-Law to take the action recommended in such report, failing which the Municipality may do so, and the person who contravened the By-Law shall be liable for the cost thereof.

**44. Offences.** —(1) A person commits an offence if that person —

(a) litters or dumps —

(i) waste in excess over 8m<sup>3</sup>; or

(ii) any volume of hazardous waste;

(b) spills or allows leakage of —

(i) waste in excess of 8m<sup>3</sup>; or

(ii) any volume of hazardous waste, without putting in place suitable measures;

(c) conveys an uncovered or unsecured load —

(i) of any volume of hazardous waste;

(ii) which results in spillage of —

(aa) waste in excess of 8m<sup>3</sup>; or

(bb) any volume of hazardous waste;

(d) hinders or interferes with —

(i) a service provider;

(ii) a waste disposal facility operator; or

(iii) an authorised municipal official,

in the exercise of their powers or the performance of their duties in terms of this By-law;

(e) contravenes or fails to comply with —

(i) sections 9(3), 9(11) and 9(12) (Building waste);

(ii) section 11(1) (Event waste);

(iii) section 22 (Storage and receptacles for general waste); or

(iv) section 41 (Duty to produce documents);

- (f) contravenes or fails to comply with —
- (i) section 5 (Obligations of waste generators);
  - (ii) sections 10(1), 10(7), 10(8), 10(13) and 10(14) (Hazardous waste);
  - (iii) sections 11(1) and 11(5) (Event waste);
  - (iv) section 12(1)(b) (Organic waste);
  - (v) section 13(1) (Bulky waste);
  - (vi) section 14(1) (Waste tyres);
  - (vii) sections 23(1), 23(2) and 23(6) (Storage, separation, recycling, re-use, sorting and recovery of waste);
  - (viii) section 24(1) (Prohibition on unauthorised disposal of waste);
  - (ix) section 25 (Prohibition on burning of waste);
  - (x) sections 26(1) and 26(2) (Prohibition on littering and dumping);
  - (xi) section 33 (Collection of unsuitable waste);
  - (xii) section 34 (Waste transfer facility);
  - (xiii) section 35(6) (Disposal of waste); or
  - (xiv) section 51(5) (Ownership of waste);
- (g) contravenes or fails to comply with a compliance notice issued in terms of section 39(1) (Compliance notices);
- (h) contravenes or fails to comply with a directive issued in terms of —
- (i) section 9(2) (Building waste);
  - (ii) section 11(6) (Event waste);
  - (iii) section 12(2) (Organic waste);
  - (iv) section 13(3) (Bulky waste);
  - (v) section 20(8) (Integrated waste management plan);
  - (vi) sections 23(4) and 23(5) (Storage, separation, recycling, re-use, sorting and recovery of waste);
  - (vii) section 24(2) (Prohibition on unauthorised disposal of waste);
  - (viii) section 27(1) (Prohibition of nuisance);
  - (ix) section 37 (Premises inaccessible for waste collection);
  - (x) section 38(1) (Directives); or
  - (xi) section 40(4) (Appeals).
- (i) falsely pretends to be an authorised municipal official or waste disposal facility operator;
- (j) furnishes false or misleading information when complying with a provision of this By-law;
- (k) unlawfully and intentionally or negligently, performs any act or omits to do anything in relation to waste, that detrimentally affects, or is likely to detrimentally affect or impact on health, well-being, public safety and the environment;
- (l) fails to submit or comply with an integrated waste management plan as provided for in this By-law;
- (m) contravenes or fails to comply with a notice contemplated in section —
- (i) section 9(5) (Building waste);
  - (ii) section 10(2) and 10(8)(c) (Hazardous waste);
  - (iii) sections 14(2) and 14(7) (Waste tyres);
  - (iv) sections 20(11) and 20(12)(b)(iii) (Integrated waste management plan);
  - (v) section 26(4) (Prohibition on littering and dumping);
  - (vi) section 30(2)(d) (Collection and transportation of general waste);
  - (vii) section 40(4) (Appeal); or
  - (viii) section 43 (Failure to comply);
- (n) contravenes or fails to comply with an instruction issued in terms of section 35(3) (Disposal of waste);
- (o) contravenes or fails to comply with a compliance notice issued in terms of section 39;
- (p) contravenes or fails to comply with an integrated waste management plan contemplated in section 20; or
- (q) contravenes or fails to comply with a condition subject to which exemption from a provision of this By-law was granted in terms of sections 21 and 53.

(2) Any person who —  
 (a) induces, influences, persuades or forces an employee of the Municipality or other person to commit an offence in terms of this By-law, or  
 (b) attempts to do so,  
 is guilty of an offence.

(3) Any person who induces an employee of the Municipality to collect and dispose of waste without —  
 (a) the correct payment to the Council; or  
 (b) the correct methods being employed,  
 is guilty of an offence.

**45. Penalties.** —(1) A person convicted of an offence in terms of section 44(1)(a), (b), (c) or (e) is liable to a fine or imprisonment for a period not exceeding one month, and in the case of a second or subsequent conviction, to a fine or imprisonment for a period not exceeding two months, or in both instances, to both such fines and such imprisonment.

(2) A person convicted of an offence in terms of section 44(1)(d), (f), (g), (h), (k), (l), (m), (n), (o), (p) or (q) or section 44(2) or (3) is liable to a fine or imprisonment for a period not exceeding one year, and in the case of a second or subsequent conviction, to a fine or imprisonment for a period not exceeding two years, or in both instances, to both such fines and such imprisonment.

(3) A person convicted of an offence in terms of section 44(1)(i) or (j) is liable to a fine or imprisonment for a period not exceeding two years, and in the case of a second or subsequent conviction, to a fine or imprisonment for a period not exceeding four years, or in both instances, to both such fines and such imprisonment.

(4) A sentence contemplated in subsection (1), (2) or (3) must be determined with due consideration of the —

- (a) severity of the offence in terms of its impact or potential impact on health, well-being, public safety and the environment;
- (b) fact that a person delayed in complying with, or failed to comply with, the terms of notices or directions given to that person under this By-law; and
- (c) monetary or other benefits that accrued, or that were to accrue, to the convicted person through the commission of the offence.

(5) The court may in addition to any penalty imposed in terms of subsection (4), order a person to repair the damage, make good the loss, rehabilitate the environment, remove waste, or determine what measures must be taken by such person and the payment of the expenses incurred in respect thereof or any other costs or damages.

**46. Seizure and impounding of vehicles.** —(1) A peace officer may, without a warrant, seize and impound a vehicle which is concerned or is on reasonable grounds believed to be concerned with the commission of an offence under this By-law.

(2) The peace officer must, at the time of impoundment, give the holder of the seized and impounded vehicle a copy of a notice setting out the —

- (a) reason for the impoundment;
- (b) description of the vehicle being impounded;
- (c) address and contact details of the designated pound;

- (d) payment of an impoundment fee; and
- (e) possibility of the impounded vehicle being sold to recover the costs.

(3) A vehicle which has been seized and impounded in terms of subsection (1) and (2) must be taken to a designated pound where it will be retained and dealt with in terms of subsection (4).

(4) The seized and impounded vehicle will be released immediately under the following conditions:

- (a) if a criminal charge is not laid or no fine is issued within 48 hours of the seizure of the vehicle;
- (b) when the criminal charges against the person have been withdrawn;
- (c) when the person has been acquitted of the offence charged; or
- (d) in the case where the person is convicted of the offence charged, and unless the court has ordered otherwise, on payment of the impoundment fee to the authorised official of the vehicle impoundment facility of the Municipality.

**47. Designation of certain officials** —(1) The municipal manager may—

- (a) designate any staff member of the Municipality as an authorised municipal official;
- (b) designate any staff member of—
  - (i) the Municipality;
  - (ii) any other organ of state; or
  - (iii) a service provider;
 as a waste disposal facility operator, and
- (c) at any time withdraw a said designation.

(2) A designation contemplated in subsection (1)(b)(ii) may be made only by agreement between the municipal manager and the relevant organ of state.

**48. Delegations by waste management officer.** —The waste management officer may delegate to any other official of the Municipality any of his or her powers or obligations in terms of this By-law.

**49. Functions and powers of waste management officer.** —The waste management officer is responsible for —

- (a) regulating and controlling waste management; and
- (b) enforcing the provisions of this By-Law, national and provincial legislation relating to waste management.

**50. Functions of authorised municipal officials and waste disposal facility operators.**

—(1) An authorised municipal official —

- (a) must administer, implement and enforce this By-law; and
- (b) may perform any function assigned to an authorised municipal official by this By-law, including the following: —
  - (i) conducting an inspection,
  - (ii) investigating any act or omission that may constitute an offence in terms of this By-law, and
  - (iii) monitoring and enforcing compliance with this By-law.

(2) A waste disposal facility operator must administer, implement and enforce this By-law at a municipal waste transfer facility, general waste storage facility, recycling facility or waste disposal facility, as the case may be.

**51. Ownership of waste.** —(1) A person who generates waste is the owner of that waste until it is made available by that person for collection by the Municipality or a service provider in accordance with this By-law.

(2) Waste becomes the property of the Municipality once it is made available for collection, whether put out for collection or made available for collection on the private premises concerned.

(3) Subsections (1) and (2) do not apply to waste streams identified in terms of section 30(2)(d) and to waste disposed of unlawfully.

(4) A person who generates waste contemplated in subsection (3) remains the owner of the waste until the waste is disposed of lawfully.

(5) When the premises listed here, are controlled by the Municipality, waste on such premises is the property of the Municipality:

(a) waste disposal facilities;

(b) waste transfer facilities; and

(c) facilities where waste is received, stored, recovered or treated, and

no person may remove from, or interfere with, waste on such premises, unless authorised to do so by the Municipality.

(6) Notwithstanding the provisions of subsections (2) and (5), the Municipality may, by means of a written agreement, transfer ownership of waste to a contractor, an owner of a landfill, a recycler, a rubble crusher, a green waste chipper or other entity, as the case may be.

**52. Liability to pay tariffs.** —(1) The owner of premises for which the Municipality is providing waste management services contemplated in this By-law, is liable for the payment of tariffs in accordance with the Tariff Policy and Tariff By-Law.

(2) The Municipality may exempt or grant a rebate to any person or category of persons that is regarded to be indigent in terms of the municipal indigent policy from paying tariffs for waste management services.

**53. Exemptions.** —(1) A person may apply in writing to the Municipality for exemption from any provision of this By-law.

(2) An application contemplated in subsection (1) must be in a format determined by the Municipality and must be accompanied by a motivation for the exemption.

(3) The Municipality may, in writing, —

(a) grant a full exemption;

(b) grant a conditional exemption;

(c) amend or cancel —

(i) an exemption;

(ii) a condition of an exemption; or

(d) refuse to grant an exemption.

(4) In order to consider an application contemplated in subsection (1), the Municipality may obtain comments from members of the public who would be affected by the granting of the exemption.

(5) If an exemption is granted subject to conditions, the exemption does not take effect until the applicant has submitted a written undertaking to the Municipality that he or she will comply with all such conditions.

(6) If the applicant fails to comply with a condition of the exemption, the exemption is suspended with immediate effect.

**54. Limitation of liability** —Neither the Municipality nor any other person is liable for any damage or loss caused by the —

(a) exercise of any power or the performance of any duty under this By-law; or

(b) failure to exercise any power or perform any duty under this By-law, unless the exercise or performance of, or the failure to exercise or perform such power or duty, is unlawful and —

(i) negligent; or

(ii) in bad faith.

**55. Amendments to waste removal services.** —The Municipality may amend any existing waste removal or cleansing services once a process of public notification, participation and comment has been completed: Provided the amendment is practical, cost effective and has as its objective the —

(a) prevention of the proliferation of waste;

(b) minimisation of waste; or

(c) reduction of waste to be removed.

**56. Transitional provisions.** —(1) Any approval given in accordance with previous By-laws will be valid in respect of the premises for which they were granted and in respect of the person to whom they were granted.

(2) No approval as contemplated in subsection (1) may be transferred to any other person.

**57. Guidelines.** —(1) The Council may issue guidelines to facilitate achievement of the objects and purposes of this By-law not inconsistent with this By-law and any other law.

(2) Any guideline contemplated in subsection (1) must be published in the *Provincial Gazette* and on the Municipality's website.

**58. Repeal of By-laws.** —The By-laws in Schedule 1 hereto are hereby repealed.

**59. Interpretation.** —In the event of a conflict between the English, isiXhosa and Afrikaans versions of this By-law, the English version shall be decisive.

**60. Short title.** —This By-law is called Stellenbosch Municipality: Integrated Waste Management By-law, 2020.

**SCHEDULE 1**

**REPEALED LAWS**



# **ANNEXURE B**



ITEM NUMBER	LEGISLATIVE MANDATE	DESCRIPTION OF POWER OR FUNCTION	RESPONSIBILITY / DELEGATED FROM	DELEGATED TO	SUB-DELEGATED TO	CONDITIONS/ LIMITATIONS/ INSTRUCTION TO ASSIST
<b>Integrated Waste Management By -Law</b>						
IWM1	Integrated Waste Management S5(3)	Conclude a Contract with a Waste Generator	Municipal manager	Director: Infrastructure Services	Senior manager: Waste management	
IWM2	Integrated Waste Management S6(1)	Granting application for additional containers	Director: Infrastructure Services	Senior Manager: Waste management	Manager: Area Cleaning and Waste Collection	
IWM3	Integrated Waste Management S6(3)	Deciding to provide another container at the cost of the waste generator	Municipal Manager	Director: Infrastructure Services	Senior Manager: Waste management	
IWM4	Integrated Waste Management S6(4)	Awarding a Container to each dwelling or structure on a property	Municipal Manager	Director: Infrastructure Services	Senior Manager: Waste management	
IWM5	Integrated Waste Management S7(1)	Concluding a Contract with an Industrial Waste Generator	Municipal manager	Director: Infrastructure Services	Senior manager: Waste management	
IWM6	Integrated Waste Management S8(2)	Stipulate Maximum Quantities of Garden Waste that may be collected and imposing conditions regarding disposal of garden waste	Municipal manager	Director: Infrastructure Services	Senior manager: Waste management	
IWM7	Integrated Waste Management S9(2)	Issue directives to a building waste generator after receiving building plans of a building to be constructed	Municipal manager	Director: Infrastructure Services	Senior manager: Waste management	
IWM8	Integrated Waste Management S9(5)	Placing a notice in the Provincial Gazette as to the registration process of building waste removal services	Municipal manager	Director: Infrastructure Services		
IWM9	Integrated Waste Management S9(7)	Consider application to register as a building waste remover	Municipal manager	Director: Infrastructure Services	Senior manager: Waste management	
IWM10	Integrated Waste Management S9(5)	Approval to allow the placement of an appropriate receptacle on a pavement	Municipal manager	Director: Infrastructure Services	Senior manager: Waste management	

ITEM NUMBER	LEGISLATIVE MANDATE	DESCRIPTION OF POWER OR FUNCTION	RESPONSIBILITY / DELEGATED FROM	DELEGATED TO	SUB-DELEGATED TO	CONDITIONS/ LIMITATIONS/ INSTRUCTION TO ASSIST
<b>Integrated Waste Management By -Law</b>						
IWM11	Integrated Waste Management S9(15)	Building Inspector to determine if building waste has been disposed off in the prescribed manner	Director: Planning and Economic Development	Snr Manager: Development Management New Post	Manager: Building Development Management	
IWM12	Integrated Waste Management S10(2)	Placing a notice in the Provincial Gazette as to the registration process of Hazardous Waste	Municipal manager	Director: Infrastructure Services		
IWM13	Integrated Waste Management S10(4)	Consider application to register as a Hazardous waste remover	Municipal manager	Director: Infrastructure Services	Senior manager: Waste management	
IWM14	Integrated Waste Management S10(12)	Publish a list of additional hazardous waste that requires classification	Municipal manager	Director: Infrastructure Services	Senior manager: Waste management	
IWM15	Integrated Waste Management S11(1)	Approve generating of event waste	Municipal manager	Director: Infrastructure Services	Senior manager: Waste management	
IWM16	Integrated Waste Management S11(6)	Issue directive for event waste was not cleaned up	Municipal manager	Director: Infrastructure Services	Senior manager: Waste management	
IWM17	Integrated Waste Management S11(8)	Arrange for waste to be cleaned at the cost of the waste generator	Director: Infrastructure Services	Senior Manager: Waste management	Manager: Area Cleaning and Waste Collection	
IWM18	Integrated Waste Management S12(2)	Issue directive to generate integrated refuse plan for Organic Waste	Municipal manager	Director: Infrastructure Services	Senior manager: Waste management	
IWM19	Integrated Waste Management S12(3)	Approval to provide an appropriate Organic Waste receptacle	Municipal manager	Director: Infrastructure Services	Senior manager: Waste management	
IWM20	Integrated Waste Management S13(1)	Approval to remove Bulky Waste	Municipal manager	Director: Infrastructure Services	Senior manager: Waste management	
IWM21	Integrated Waste Management S13(3)	Issue directive to bulky waste collector to submit monthly reports	Municipal manager			

ITEM NUMBER	LEGISLATIVE MANDATE	DESCRIPTION OF POWER OR FUNCTION	RESPONSIBILITY / DELEGATED FROM	DELEGATED TO	SUB-DELEGATED TO	CONDITIONS/ LIMITATIONS/ INSTRUCTION TO ASSIST
<b>Integrated Waste Management By -Law</b>						
IWM22	Integrated Waste Management S14(2)	Placing a notice in the Provincial Gazette as to the registration process of Waste tyres	Municipal manager	Director: Infrastructure Services		
IWM23	Integrated Waste Management S14(4)	Consider application to register as a waste tyres remover	Municipal manager	Director: Infrastructure Services	Senior manager: Waste management	
IWM24	Integrated Waste Management S14(7)	Placing a notice in the Provincial Gazette as to the designated facilities that waste tyres may be disposed at.	Municipal manager	Director: Infrastructure Services		
IWM25	Integrated Waste Management S15(1)	Categorize Priority Waste	Director: Infrastructure Services	Senior Manager: Waste management		
IWM26	Integrated Waste Management S16	Approve the removal of abandoned articles	Municipal manager	Director: Infrastructure Services	Senior manager: Waste management	
IWM27	Integrated Waste Management S17	Emergency procedures to manage waste	Director: Infrastructure Services	Senior Manager: Waste management		
IWM28	Integrated Waste Management S19(1)	Providing special dispensation to waste management clubs	Director: Infrastructure Services	Senior Manager: Waste management		
IWM29	Integrated Waste Management S20(11)	Request information to prepare an Integrated Waste Management Plan	Director: Infrastructure Services	Senior Manager: Waste management		
IWM30	Integrated Waste Management S21(1))	Exempting a waste generator from providing a waste management plan	Director: Infrastructure Services	Senior Manager: Waste management		
IWM31	Integrated Waste Management S23(2)	Awarding accreditation as waste storage, separation, recycling, re-use, sorting and recovering	Director: Infrastructure Services	Senior Manager: Waste management		
IWM32	Integrated Waste Management S23(3)	Exempt waste generators	Director: Infrastructure Services	Senior Manager: Waste management		

ITEM NUMBER	LEGISLATIVE MANDATE	DESCRIPTION OF POWER OR FUNCTION	RESPONSIBILITY / DELEGATED FROM	DELEGATED TO	SUB-DELEGATED TO	CONDITIONS/ LIMITATIONS/ INSTRUCTION TO ASSIST
<b>Integrated Waste Management By -Law</b>						
IWM33	Integrated Waste Management S23(4)	Providing a directive to a waste generator to report	Municipal Manager			
IWM34	Integrated Waste Management S23(5)	Request Waste Generator to separate recyclable waste	Municipal Manager			
IWM35	Integrated Waste Management S24	Issuing directive when a person is contradiction of this By-Law	Municipal Manager			
IWM36	Integrated Waste Management S25	Approval of the burning of waste in a thermal treatment facility	Municipal manager	Director: Infrastructure Services	Senior manager: Waste management	
IWM37	Integrated Waste Management S26	Issuing notice to an offender that has littered or dumped	Director: Infrastructure Services	Senior Manager: Waste management	Manager: Area Cleaning and Waste Collection	
IWM38	Integrated Waste Management S27	Issuing a notice of prohibition	Municipal Manager			
IWM39	Integrated Waste Management S28	Issuing a license to any person or entity to handle waste	Director: Infrastructure Services	Senior Manager: Waste management	Manager: Area Cleaning and Waste Collection	
IWM40	Integrated Waste Management S29	Setting a schedule for collection and transporting of waste	Municipal manager	Director: Infrastructure Services	Senior manager: Waste management	
IWM41	Integrated Waste Management S31	Keeping a register of accredited service providers	Director: Infrastructure Services	Senior Manager: Waste management	Manager: Area Cleaning and Waste Collection	
IWM42	Integrated Waste Management S32	Accrediting transporter of waste for gain	Municipal manager	Director: Infrastructure Services	Senior manager: Waste management	
IWM43	Integrated Waste Management S35	Authorize Municipal Officials to inspect any waste facility	Municipal manager	Director: Infrastructure Services	Senior manager: Waste management	
IWM44	Integrated Waste Management S37	Issuing directive to take specific measures to make the collection of waste possible	Municipal manager			
IWM45	Integrated Waste Management S38	Issuing directives wrt any part of the By Law	Municipal Manager			

ITEM NUMBER	LEGISLATIVE MANDATE	DESCRIPTION OF POWER OR FUNCTION	RESPONSIBILITY / DELEGATED FROM	DELEGATED TO	SUB-DELEGATED TO	CONDITIONS/ LIMITATIONS/ INSTRUCTION TO ASSIST
Integrated Waste Management By -Law						
IWM46	Integrated Waste Management S39	Authorizing an official to issue written compliance notices	Municipal manager	Director: Infrastructure Services		
IWM47	Integrated Waste Management S43	Issuing compliance notices	Director: Infrastructure Services	Senior Manager: Waste management		
IWM48	Integrated Waste Management S48	Designation of certain officials	Municipal manager			
IWM49	Integrated Waste Management S53	Exemptions	Municipal manager			

Section Contravened	Description of Offence	Proposed Fine (1)	Approved Fine (2)
44(1)(a)	litters or dumps — (i) waste in excess over 8m <sup>3</sup> ; or (ii) any volume of hazardous waste;	R1000	
44(1)(b)	spills or allows leakage of — (i) waste in excess of 8m <sup>3</sup> ; or (ii) any volume of hazardous waste, without putting in place suitable measures;	R1000	
44(1)(c)	conveys an uncovered or unsecured load — (i) of any volume of hazardous waste; (ii) which results in spillage of — (aa) waste in excess of 8m <sup>3</sup> ; or (bb) any volume of hazardous waste;	R1000	
44(1)(d)	hinders or interferes with — (i) a service provider; (ii) a waste disposal facility operator; or (iii) an authorised municipal official, in the exercise of their powers or the performance of their duties in terms of this By-law;	R500	
44(1)(e)	contravenes or fails to comply with — (i) sections 9(3), 9(11) and 9(12) (Building waste); (ii) section 11(1) (Event waste); (iii) section 22 (Storage and receptacles for general waste); or (iv) section 41 (Duty to produce documents);	R500	



44(1)(f)	<p>contravenes or fails to comply with</p> <p>—</p> <ul style="list-style-type: none"> <li>(i) section 5 (Obligations of waste generators);</li> <li>(ii) sections 10(1), 10(7), 10(8), 10(13) and 10(14) (Hazardous waste);</li> <li>(iii) sections 11(1) and 11(5) (Event waste);</li> <li>(iv) section 12(1)(b) (Organic waste);</li> <li>(v) section 13(1) (Bulky waste);</li> <li>(vi) section 14(1) (Waste tyres);</li> <li>(vii) sections 23(1), 23(2) and 23(6) (Storage, separation, recycling, re-use, sorting and recovery of waste);</li> <li>(viii) section 24(1) (Prohibition on unauthorised disposal of waste);</li> <li>(ix) section 25 (Prohibition on burning of waste);</li> <li>(x) sections 26(1) and 26(2) (Prohibition on littering and dumping);</li> <li>(xi) section 33 (Collection of unsuitable waste);</li> <li>(xii) section 34 (Waste transfer facility);</li> <li>(xiii) section 35(6) (Disposal of waste); or</li> <li>(xiv) section 51(5) Ownership of</li> </ul>	R500	
44(1)(g)	<p>contravenes or fails to comply with a compliance notice issued in terms of section 39(1) (Compliance notices);</p>	R1000	

44(1)(h)	<p>contravenes or fails to comply with a directive issued in terms of —</p> <ul style="list-style-type: none"> <li>(i) section 9(2) (Building waste);</li> <li>(ii) section 11(6) (Event waste);</li> <li>(iii) section 12(2) (Organic waste);</li> <li>(iv) section 13(3) (Bulky waste);</li> <li>(v) section 20(8) (Integrated waste management plan);</li> <li>(vi) sections 23(4) and 23(5) (Storage, separation, recycling, re-use, sorting and recovery of waste);</li> <li>(vii) section 24(2) (Prohibition on unauthorised disposal of waste);</li> <li>(viii) section 27(1) (Prohibition of nuisance);</li> <li>(ix) section 37 (Premises inaccessible for waste collection);</li> <li>(x) section 38(1) (Directives);</li> <li>or</li> <li>(xi) section 40(4) (Appeals</li> </ul>	R1000	
44(1)(i)	falsely pretends to be an authorised municipal official or waste disposal facility operator;	NAG	
44(1)(j)	furnishes false or misleading information when complying with a provision of this By-law;	NAG	
44(1)(k)	unlawfully and intentionally or negligently, performs any act or omits to do anything in relation to waste, that detrimentally affects, or is likely to detrimentally affect or impact on health, well-being, public safety and the environment;	R2500	
44(1)(l)	fails to submit or comply with an integrated waste management plan as provided for in this By-law;	R1000	

44(1)(m)	<p>contravenes or fails to comply with a notice contemplated in section —</p> <ul style="list-style-type: none"> <li>(i) section 9(5) (Building waste);</li> <li>(ii) section 10(2) and 10(8)(c) (Hazardous waste);</li> <li>(iii) sections 14(2) and 14(7) (Waste tyres);</li> <li>(iv) sections 20(11) and 20(12)(b)(iii) (Integrated waste management plan);</li> <li>(v) section 26(4) (Prohibition on littering and dumping);</li> <li>(vi) section 30(2)(d) (Collection and transportation of general waste);</li> <li>(vii) section 40(4) (Appeal); or</li> <li>(viii) section 43 (Failure to comply);</li> </ul>	R2 500	
44(1)(n)	<p>contravenes or fails to comply with an instruction issued in terms of section 35(3) (Disposal of waste);</p>	R1 000	
44(1)(o)	<p>contravenes or fails to comply with a compliance notice issued in terms of section 39;</p>	R1 000	
44(1)(p)	<p>contravenes or fails to comply with an integrated waste management plan contemplated in section 20; or</p>	R1 000	
44(1)(q)	<p>contravenes or fails to comply with a condition subject to which exemption from a provision of this By-law was granted in terms of sections 21 and 53.</p>	R2 500	
44(2)	<p>Any person who —</p> <ul style="list-style-type: none"> <li>(a) induces, influences, persuades or forces an employee of the Municipality or other person to commit an offence in terms of this By-law, or</li> <li>(b) attempts to do so,</li> </ul>	NAG	

44(3)	Any person who induces an employee of the Municipality to collect and dispose of waste without — (a) the correct payment to the Council; or (b) the correct methods being employed,	NAG	
-------	---	-----	--

NAG = No Admission of Guilt fine allowed

13.6	<b>LEASE OF COUNCIL-OWNED LAND FOR (ADDITIONAL) PARKING PURPOSES: ATTERBURY: PORTION OF LEASE FARM 369P</b>
------	---

Collaborator No:

IDP KPA Ref No:

**GOOD GOVERNANCE**

Meeting Date:

**25 November 2020**

**1. SUBJECT: LEASE OF COUNCIL-OWNED LAND FOR (ADDITIONAL) PARKING PURPOSES: ATTERBURY: PORTION OF LEASE FARM 369P**

**2. PURPOSE**

To obtain Council approval (in principle) to enter into a lease Agreement with Atterbury for the use of a portion of Council-owned land for parking purposes.

**3. DELEGATED AUTHORITY**

Council

Executive Mayor in consultation with the Executive Mayoral Committee if the lease is for less than 10 years and the value of the lease if less than R5 million.

As this item was received after closure of the Mayco agenda, the Executive Mayor requested that the item serves at Council.

**4. EXECUTIVE SUMMARY**

Atterbury, the owners of Portion 3 of Farm 961, Stellenbosch apply to use a portion of Lease Farm 369 for parking purposes. The land they want to lease is adjacent to their property.

When this property (Farm 961/3) was previously owned by Medi Clinic, they had an Encroachment Agreement with Council to use the portion of Lease Farm 369P for parking purposes. This area was excluded from the K.W.V Lease Agreement. They developed the parking on the piece of land. This encroachment agreement, however, lapsed when they sold the property and relocated their offices to the ex-BAT property in Stellenbosch.

Atterbury has now applied to use the already developed parking area consisting of 100 parking bays for additional parking bays for their staff. They also applied for an encroachment, which in effect amounts to a lease agreement. It was decided that encroachments will no longer be used for these kind of applications. In the light of the change in direction on encroachment leases, a short term lease is proposed as the parking is currently being used on a daily basis without any income to Council.

Council must now, in principle, consider the application.

**5. RECOMMENDATIONS**

- (a) that the portion of Lease Farm 369P, consisting of 100 parking bays be identified as land not needed for any other municipal service;
- (b) that council in principle approves the lease agreement with Atterbury, to enable them to use a portion of Lease Farm 369P, consisting of 100 parking bays;

- (c) that Council's intention to conclude a lease Agreement with Atterbury for a period of 12 months without following a supply chain process be advertised for public comments/inputs/objections, whereafter a return item will be submitted to Council to make a final determination in this regard;
- (d) that council lease the land based on the "encroachment" parking tariffs as approved in the latest tariff book; and
- (e) that the applicants be allowed to use the parking bays until council can make a final determination provided that the tariff set out in the tariff book is paid on a monthly basis.

## 6. DISCUSSION / CONTENT

### 6.1 Background

#### 6.1.1 Encroachment Agreement with Medi - Clinic to use a portion of Lease Farm 369 for parking purposes

When Medi-Clinic was the owner of the Portion 3 of Farm 961, Stellenbosch, they applied for an Encroachment permit to allow them to use the area for parking purposes. The agreement was approved (with the consent of KWV), but has since lapsed, when Medi-Clinic sold the property to Atterbury, following their relocation to the ex-BAT offices in Stellenbosch.

#### 6.1.2 Application from Atterbury to use a Portion of Lease Farm 369P for parking purposes

Hereto attached as **APPENDIX 1** an application received from Atterbury to use a portion of Lease Farm 369P, consisting of 100 parking bays, for additional parking purposes for their staff.

## 6.2 DISCUSSION

### 6.2.1 Location and context

The property under discussion is situated off Trumali Street, Brandwacht, as shown on Fig 1 and 2 below. The area has been developed by Medi-Clinic when they were leasing it from Council, at their cost. The area consists of 100 parking bays that was built by Medi Clinic when they used the area for parking under the encroachment.

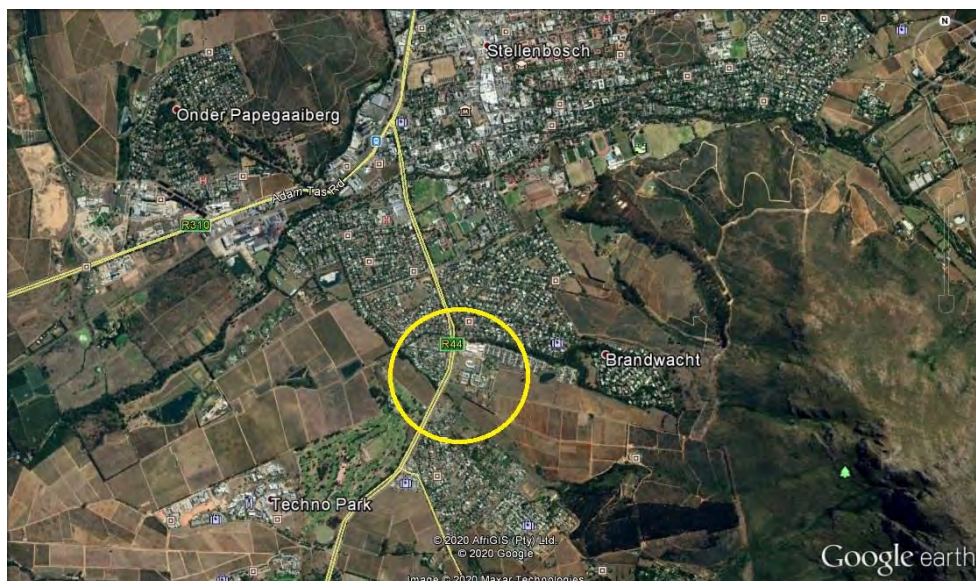

**Fig 1: Location and context**



**Fig 2: Proposed encroachment area**



**Fig 3: Developed parking area**

**6.3 Financial implication**

**6.3.1** The tariffs for parking areas amount to R195.00 per parking bay (as per the recently approved tariff structure) for the first 10 parking bays and thereafter 50% of the tariff (R97,50) per month. This amounts to (R 1950.00 + R8775.00) R10 725 per month (inclusive of VAT). By leasing the parking area to the applicants, council will receive the income whereas at the moment people use the area for free.

Council can either use the tariff rate or get a rental valuation to determine the rental amount.

**6.4 Legal requirements**

**6.4.1 Municipal Asset Transfer Regulations**

In terms of Section 36 of the Municipal Asset Transfer Regulation, when considering an application for an approval of a right to use municipal property, the following needs to be taken into account, *inter alia*:-

- a) whether the capital asset may **be required for the municipality’s own use** during the period for which the right is to be granted;
- b) the extent to which any compensation to be received for the right, together with the estimated value of improvements or enhancements to the asset, will result in a financial benefit to the municipality;
- c) the (possible) risks and rewards associated with the use in relation to the municipality’s interests;
- d) Any comments received from the local community, and
- e) Compliance with the legislative regime applicable to the proposed granting of the right.

**6.4.2 Property Management Policy**

Council must also advertise the intent to rent the property to the applicants on what is regarded as a private treaty basis as provided for in the Asset Management Policy before a final determination on the application can be made.

In terms of paragraph 9.2.2 of the Policy, the Municipal Council may dispense with the prescribed, competitive process, and may enter into a private treaty agreement through any convenient process, which may include direct negotiations, but only in specific circumstances, and only after having advertised Council’s intention so to act. One of the circumstances listed in (h) is where encroachment applications are received from adjoining owners, subject to approved tariff structure.

**6.5 Inputs received from Departments**

**6.5.1 Director: Infrastructure Services**

“3. Responsibility for Electrical Installations (1).....

.....

(3) Where there is a written undertaking between a user or lessor and a lessee whereby the responsibility for an electrical installation has been transferred to the lessee, the lessee shall be responsible for that installation as if he or she where user or lessor.”

The transfer of responsibility must be in writing within the contract.

No further inputs from senior managers was received and the return item will be circulated for comments.

**ANNEXURES:**

Appendix 1: Application



# **APPENDIX 1**



# STELLENBOSCH

STELLENBOSCH • PNIEL • FRANSCHHOEK

MUNICIPALITY • UMASIPALA • MUNISIPALITEIT

## ENCROACHMENT PERMIT APPLICATION FORM

### A: APPLICANT'S DETAILS

Name : ATTSTEIN (PTY) LTD

Physical address: 101 DORP STREET  
STELLENBOSCH

Postal code: 7600

Mailing address: POSTNET SUITE 205  
PRIVATE BAG X20009  
GARLFONTEIN

Postal code: 0042

E-mail address: danelle@atterbury.co.za

Telephone: 021 808 1000

Cell phone: 079 886 0412

### B: PROPERTY DETAILS OF APPLICANT

Erf/farm number : Remainder farm 961

Suburb: Stellenbosch

Town: .....

**C: PROPERTY DETAILS OF ENCROACHMENT AREA**

Erf/farm number : .....

Suburb: .....

Town: .....

Area of encroachment: .....m<sup>2</sup>

\* To be supplemented with a sketch-plan with dimension in m<sup>2</sup>

**D: TYPE OF APPLICATION:**

Please mark the appropriate block

For commercial purposes, other than for parking

For commercial parking purposes,

For residential parking purposes

For non-commercial purposes (such as garden purposes, gates,ect)

For projecting structures onto street reserves

For projecting structures onto other council-owned land

Other: please provide description:

Brief description of application: lease of encroachment  
of 100 parking bays from city  
council.

Motivation: WE own the adjacent  
building and would like to require  
additional parking for our tenants.

.....  
.....

**E: LIST OF ATTACHEMENTS AND SUPPORTING DOCUMENTS**

Please mark the appropriate box

- Special Power of Attorney, where Applicant is not the owner
- Diagram of proposed area of encroachment
- Letters of consent (affected neighbours)
- Application fee - non-refundable

I hereby certify that the information supplied in this application form is correct and that I am property authorized to make this application.

Applicant's signature: .....

Date: 22.05.2018

Full name: GERRIT VAN DEN BERG

**FOR OFFICIAL USE**

- The application was considered on .....by.....
- The application was

**APPROVED**

**NOT APPROVED**

Conditions (if any): .....

.....

.....

Applicant was informed of outcome on .....

.....  
**SIGNATURE OF RESPONSIBLE OFFICIAL**

.....  
**DATE**

Name:.....

**\*If approved**

- Encroachment fee paid
- Encroachment Agreement signed
- Agreement/Permit processed on Contract Management System

.....  
**SIGNATURE OF RESPONSIBLE OFFICIAL**

.....  
**DATE**

Name:.....

**6 PRINTING FEES**

- 6.1 Printing fees are charged per page according to size and colour. The three types of copies/prints are mono (black & white), Colour line prints and Full Colour prints (photo). Copies will only be made in the sizes that are available at a particular office.
- 6.2 The fee charged for electronic information does not include the CD, which must be supplied by the applicant.
- 6.3 Search fees are charged per half hour when the requested information takes 30 minutes or more to find or produce. If information is specifically requested in terms of the Access of Information Act, the relevant fees as prescribed in terms of that Act applies.

**SPATIAL PLANNING, HERITAGE AND ENVIRONMENT****7 PLANNING ADVISORY COMMITTEE SCRUTINY FEE**

- 7.1 Planning Advisory Committee Scrutiny fees (Aesthetics Committee) are charged when a matter needs to be submitted to the Planning Advisory Committee (Heritage/Aesthetics Committee) for scrutiny, when buildings are older than 60 years or situated in the historical core. The fees are payable per application and are categorized as follows:
  - 7.1.1 Minor alterations to existing buildings <500m<sup>2</sup>;
  - 7.1.2 Major alterations to existing buildings >500m<sup>2</sup> and new developments.

**8 COMPLEXITY FEES (ADDITIONAL FEES FOR HIGH IMPACT APPLICATIONS) AND AMENDMENT OF URBAN EDGES.****Description**

- 8.1 Additional fees are charged on top of the basic application fees when a Heritage Impact Assessment (HIA), Environmental Impact Assessment (EIA) and Traffic Impact Statement / Assessment (TIA/S) are required, since such applications are more complex and involve more work. The complexity fees are charged to cover additional expenses due to the processing of complex applications, resulting from the fact that such applications normally are more complicated to process and due to the fact that it requires input from specialised staff which would not normally be involved in the assessment of applications which doesn't require an impact statement/assessment. The EIA and HIA fees are charged up front like all other fees if the application requires assessment in terms of the NEMA and/or NHRA. If an EIA and/or HIA fee has been paid when the SPLUMA/LUPA/By-law application was submitted and it turns out in the end that it did not lead to a full EIA / HIA, the EIA/HIA fee is not refundable. Complexity fees are charged per assessment/study and the amendment of urban edges are charged per application.

**9 APPLICATION FOR SIGNAGE**

- 9.1 Application fees for signage (including flags) are paid in respect of each sign applied for. A minimum fee for signs smaller than 1m<sup>2</sup> is in place, but when signs are larger than 1m<sup>2</sup>, the minimum fee plus the enhancement fee will be payable for every additional m<sup>2</sup>.

**10 EXEMPTIONS**

- 10.1 All applications submitted by or on behalf of Council are exempt from all the application, advertising and other fees in the attached table. This exemption only applies to applications made by Council or where Council is the developer. All other government institutions must pay the normal fees.
- 10.2 Applications for the establishment of state, provincial and/or council subsidised housing schemes are exempt from all the application and other fees in the attached table. Advertising fees are payable in this regard. Application fees are, however applicable in subsidized housing areas after the establishment of the areas has been completed; subject to the conditions in the establishment of any of the less formal townships.
- 10.3 All applications required to address / give effect to successful resettlement claims in terms of the Restitution of Land Rights Act, as well as in cases where land has been allocated to a successful claimant, such claimant is allowed to submit only one application, for residential development only (but including subdivision, removal of restrictions, etc, related to such residential development), which application(s) are exempt from all the application and other fees in the attached table. Advertising fees are payable in this regard. If a successful land claimant submits a mixed use development application (which includes non-residential development) on land so obtained, such non-residential development gets charged the normal fees as specified for such application, including advertising and service of notice fees, as if the non-residential part of the application is a separate application from the residential part of the development. In cases where a successful land claimant submits a purely non-residential development application (which does not includes any residential development) on land so obtained, such non-residential development application is subject to all the fees applicable to any other similar application which wasn't obtained by way of the Restitution of Land Rights Act/Rural Act 9.
- 10.4 The above fees, if not specifically exempted, also applies to applications in the BCDA areas where Council is the commenting authority.
- 10.5 The Director : Planning & Economic Development may grant or refuse applications for the exemption of some or all the applicable fees of particular applications which are necessitated due to changes to the developments made at the request of the Environmental Management Services in the interest of environmental or heritage conservation.

<p>These business rules must be read in conjunction with the "LAND USE MANAGEMENT &amp; SPATIAL PLANNING, HERITAGE AND ENVIRONMENT TARIFF STRUCTURE FOR 2020/2021". Enquiries: Hedre Dednam Tel: 021 808 8674</p>
---



# STELLENBOSCH

STELLENBOSCH • PNIEL • FRANSCHHOEK

MUNICIPALITY • UMASIPALA • MUNISIPALITEIT

## TARIFF STRUCTURE: PROPERTY MANAGEMENT: 2020/2021

	DESCRIPTION	APPLICATION FEE	RENTAL/TARIFF
<b>1.</b>	<b>Encroachment Agreements/Permits</b>		
1.1	For commercial purposes, other than outdoor dining and parking purposes	R2 500.00	To be determined by an independent valuer: on an <i>ad hoc</i> basis
1.2	For commercial parking purposes*	R1 200.00	
	(a) Stellenbosch CBD, Franschhoek CBD and Technopark		R295.00/parking bay/month
	(b) Other Areas		R195.00/parking bay/month
	*Up to 10 parking buys, thereafter 50% of the approved tariff		
1.3	For residential parking purposes*	R600.00	R150.00/parking bay/month
	*Up to 3 parking buys, thereafter 50% of the approved tariff		
1.4	Tertiary Institutions, schools and pre-schools	R1 200.00	R70.00/parking bay/month
1.5	For outdoor dining purposes*	R1 200.00	
	(a) Stellenbosch CBD and Franschhoek CBD		R105.00/m <sup>2</sup> /month
	(b) Other areas		R40.00/m <sup>2</sup> /month
	*Up to 50m <sup>2</sup> , thereafter 50% of the approved tariff		
1.6	For non – commercial purposes (such as garden purposes, gates, ect.)*	R600.00	
	Up to 50m <sup>2</sup>		R60.00 per month
	51 m <sup>2</sup> to 100 m <sup>2</sup>		R80.00 per month
	More than 100 m <sup>2</sup>		R150.00 per month



DESCRIPTION	APPLICATION FEE	RENTAL
1.7 Projections and projecting structures	R2 500. 00	
(a) Onto street reserves/side walks		<b>Once of payment off:</b>
Up to 50 m <sup>2</sup>		R400.00 per m <sup>2</sup>
51 m <sup>2</sup> to 100 m <sup>2</sup>		R350.00 per m <sup>2</sup>
More than 100 m <sup>2</sup>		R300.00 per m <sup>2</sup>
(b) Onto other council – owned property, where such projection has an impact on development value of council – owned property	R3 000. 00	To be determined by an independent valuer (should the estimated value be more than R100 000.00, then the weighed average of 2 independent valuations must be obtained)
1.9 For temporary use of Council-owned property for construction work		
(a) Stellenbosch CBD and Franschhoek CBD & Technopark	R3 000.00	
Up to 20 m <sup>2</sup>		R500.00 per month
20 m <sup>2</sup> - 100 m <sup>2</sup>		R1 000.00 per month
101 m <sup>2</sup> – 1000 m <sup>2</sup>		R5 000.00 per month
More than 1000 m <sup>2</sup>		R10 000.00 per month
(b) Other areas	R 500.00	
Up to 20 m <sup>2</sup>		R200.00 per month
20 m <sup>2</sup> - 100 m <sup>2</sup>		R600.00 per month
101 m <sup>2</sup> – 1000 m <sup>2</sup>		R3 000.00 per month
More than 1000 m <sup>2</sup>		R7 000.00 per month
Deposit:		An amount to be determined by MPM in relation to the potential risk to infrastructure/improvement with a minimum amount of R2 000.00

**\*Please note:** Where a new owner of a property want to apply for a change in name, 20% of application fees will be payable

**2. Lease Agreements\***

2.1	Temporary use of Council-owned property to a maximum of 30 days	R600.00	
	Daily tariff:		
	a) Up to 100m <sup>2</sup>		R220.00 per day
	b) Between 100m <sup>2</sup> and 1000m <sup>2</sup>		R560.00 per day
	c) More than 1000m <sup>2</sup>		R2 300.00 per day
	Deposit:		To be determined by MPM, depending on the possible risk associated with the event.
2.2	Short term lease agreements (up to 10 years)		
	(a) monthly rental not exceeding R2 000.00		To be determined by CFO
	(b) monthly rental not exceeding R5 000.00		To be determined by an independent valuer
	(c) monthly rental in excess of R5 000.00		To be determined by two independent valuers (weighed average)
2.3	Long term lease agreements (longer than 10 years)		
	(a) monthly rental not exceeding R2 000.00		To be determined by CFO
	(b) monthly rental not exceeding R10 000.00		To be determined by an independent valuer
	(c) monthly rental in excess of R10 000.00		To be determined by two independent valuers (weighted average)
2.4	Long term lease agreements concluded before 2003 (pre-MFMA)		To be determined by Council from time to time as per individual contract(s).
2.5	Telecommunication structure		
	- Application/Power of Attorney	R2 000.00	
	(a) Antennae only (on existing structure)		R6 000.00/pm
	(b) Site for mast and antennae		
	-up to 100m <sup>2</sup>		R7 000.00/month
	-more than 100m <sup>2</sup>		R70.00/m <sup>2</sup> /month for each m <sup>2</sup> in excess of 100m <sup>2</sup>
	(c) Mobile antenna		R3150.00/pm
2.6	Temporary use of vacant Council-owned buildings*		
	*Not covered by approved tariff structure		
	To be considered by:	MPM: To a maximum of 1 month D:CS: To a maximum of 3 months MM: To a maximum of 6 months EM: To a maximum of 12 months	
	Tariff :		Per day: R10.00/m <sup>2</sup> /day

Per week: R9.00/m<sup>2</sup>/day  
Per month: R8.00/m<sup>2</sup>/day

NPO's and individuals, for non-commercial purposes

20% of approved tariff

**\* Please Note: -**

- All contracts with an annual contract value exceeding R1M: To be approved by Council, based on independent valuations being obtained.
- Non – profit organizations: 20% of fair market value

**3. Servitudes\***

3.1	In urban areas	R2 500.00	Once-off payment of 80% of municipal valuation of land
3.2	In rural areas	R2 500.00	Once-off payment of 60% of municipal land.

**\* Please note:**

Where estimated servitude value exceeds R100 000.00, the fair market value is to be determined by an independent valuer.

Where estimated servitude value exceeds R1M, the fair market value is to be determined by two independent valuers (weighed average)

**4. Posters**

4.1	Political parties Up to 200 posters 201 to 500 posters More than 500 posters		R5 000.00 (deposit) R25.00 per poster R30.00 per poster R50.00 per poster
4.2	For Commercial purposes (a) Up to 30 posters (b) Between 30 and 60 posters (c) Between 60 and 100 posters (d) More than 100 posters		R50.00 per poster R60.00 per additional poster R80.00 per additional poster R100.00 per additional poster
4.3	Non-commercial purposes (a) Up to 30 posters (b) Between 30 and 60 posters (c) Between 60 and 100 posters (d) More than 100 posters		R20.00 per poster R30.00 per additional poster R40.00 per additional poster R50.00 per additional poster
4.4	Wordfees: Individual artists (a) Per poster (to a maximum of 20 posters)		R55.00
4.5	Local Theaters (a) Up to 500 posters for a season (b) Up to 1000 posters for a season (c) More than to 1000 posters for a season		R4 000.00 R8 000.00 R12 000.00

## 4.6 Newspapers

**Local**

- |                                      |  |
|--------------------------------------|--|
| a) Up to 2400 posters per annum:     | R10 000.00                               |
| b) Up to 5000 posters per annum:     | R25 000.00                               |
| c) More than 5000 posters per annum: | An additional amount of R7.50 per poster |

**Other**

- |                                      |  |
|--------------------------------------|--|
| a) Up to 2400 posters per annum:     | R12 000.00                               |
| b) Up to 5000 posters per annum:     | R30 000.00                               |
| c) More than 5000 posters per annum: | An additional amount of R8.00 per poster |

**\*Note:** The term posters include flags.

**Please note:-**

- a) Application fees listed in this tariff structure exclude professional fees such as legal fees, valuation fees, survey costs, publication of notices, etc. Where such costs are incurred, it is payable by the applicant, over and above the application fee as listed in this tariff structure.
- b) All fees include VAT

<b>13.7</b>	<b>TIMEFRAMES FOR PUBLIC PARTICIPATION PERIODS FOR LAND USE -/ BUILDING DEVELOPMENT MANAGEMENT PROCESSES/OTHER PUBLIC PARTICIPATION AND TENDER PROCESSES NEEDED DURING THE 2020 FESTIVE SEASON</b>
-------------	--

Collaborator No: 698289  
IDP KPA Ref No: Good Governance and Compliance  
Meeting Date: 25 November 2020

**1. SUBJECT: TIMEFRAMES FOR PUBLIC PARTICIPATION PERIODS FOR LAND USE -/ BUILDING DEVELOPMENT MANAGEMENT PROCESSES/OTHER PUBLIC PARTICIPATION AND TENDER PROCESSES NEEDED DURING THE 2020 FESTIVE SEASON**

**2. PURPOSE**

To obtain approval for the changes to the time frames for the processing and public participation periods for land use and building development management processes and other public participation needed during the 2020 festive season.

**3. DELEGATED AUTHORITY**

Council

**4. EXECUTIVE SUMMARY**

Due to the impact of the Covid-19 pandemic and resulting National Lockdown on service delivery and the economy, it is proposed to minimize the standard practice to exclude the core festive period from the timeframes in the processing and the public participation applicable for land use and building development management applications and other public participation needed over the festive period from 15 December to 15 January to the period between 22 December 2020 to 15 January 2021. This period will not be included in the normal calculation of periods for public to comment/give inputs/land use and building development applications and processes etcetera.

**5. RECOMMENDATIONS**

- (a) that Council approves that the period between 22 December 2020 to 15 January 2021 be excluded from the timeframes in the processing and the public participation applicable to land use and building development applications as well as other municipal processes for public participation during the festive season; and
- (b) that the Municipal Manager informs the public through an advertisement in a local newspaper.

**6. DISCUSSION / CONTENTS**

**6.1 Background**

It has been standard practice and a decision of Council in terms of an adopted policy to exclude the core festive period of 15 December to 15 January from the timeframes in the processing and the public participation applicable to land use and building development management applications. The existing policy however was also drafted in terms of the Land Use Planning Ordinance, 1986, which have been repealed and replaced in the meantime by the Stellenbosch Land Use Planning Bylaw, 2015. There

---

are also other situations where the involvement of the public is required in this period and where in the past this period was excluded and the periods needs to be the same for all those processes also.

## **6.2 Discussion**

Sections 45 and 46 of the Stellenbosch Municipal Land Use Planning Bylaw, 2015 regulates the manner in which public notices must be given and served. In terms of Section 47(h) the period which must be allowed for the submission of comments on an application may not be less than 30 days for interested and affected parties, and in terms of Section 51(2) an organ of state must submit its comments within 60 days of receipt of the notice.

For the purpose of fair administrative action it is deemed reasonable and justifiable in the circumstances for a directive that the core period during the festive holiday period must not be taken into account for the purpose of calculating the number of days for the processing and the public consultation processes. It has also being the practise to exclude the period from the calculation of tender closure times as well as not publishing requests for public inputs/comments during this period.

Due to the impact of the Covid-19 pandemic and resulting National Lockdown on service delivery and the economy, it is however proposed that this period should be minimalize to the absolute core festive period, which shall consequently be regarded as the period of 22 December 2020 to 15 January 2021.

Accordingly the public consultation processes will proceed, but the commenting period will be extended accordingly to disregard the stated festive period from the required minimum number of days for the submission of such comments.

A person whose rights are affected by a decision of an authorised employee or the Tribunal in terms of Section 79 of Stellenbosch Municipal Land Use Planning By-law, 2015 may appeal within 21 days of notification of the decision. Accordingly no appeal period can commence which will be affected by the core festive period of 22 December 2020 to 15 January 2021.

No notifications of planning decisions will be communicated after 30 November 2020, and will only be communicated effectively from 18 January 2021. No requests for public input will be published during this period and tenders will not close in this period. Council is requested in a separate item to close the municipal offices between 24 December 2020 and 4 January 2021 and for that reason no administrative actions will take place during this period.

## **6.3 Financial Implications**

The payments will take place in terms of the documentation.

## **6.4 Legal Implications**

Ensure compliance to the provisions in the Stellenbosch Land Use Planning Bylaw, 2015, as well as ascribe to the principle of fair administrative action in terms of the Promotion of Administrative Justice Act, 2000. The recommendation is in line with the council policies and legislation.

**6.5 Staff Implications**

No additional staff implications. Council is requested in a separate item to close the municipal offices between 24 December 2020 and 4 January 2021, and for that reason no administrative actions are planned to take place during this period as the staff will be on compulsory leave.

**6.6 Previous / Relevant Council Resolutions**

No formal resolution.

**6.7 Risk Implications**

The risks are addressed through the recommendations.

**6.8 Comments from Senior Management**

This item was discussed at the Directors' meeting and was supported by all Directors and the Municipal Manager.

**ANNEXURES**

None

**FOR FURTHER DETAILS CONTACT:**

<b>NAME</b>	<i>Stiaan Carstens</i>
<b>POSITION</b>	<i>Senior Manager: Development Management</i>
<b>DIRECTORATE</b>	<i>Planning and Economic Development</i>
<b>CONTACT NUMBERS</b>	<i>021 808 8674</i>
<b>E-MAIL ADDRESS</b>	<i>Stiaan.carstens@ Stellenbosch.gov.za</i>
<b>REPORT DATE</b>	<i>18 November 2020</i>

13.8	<b>APPOINTMENT OF SECTION 80 PORTFOLIO CHAIRPERSONS</b>
------	---

Collaborator No:

IDP KPA Ref No:

Meeting Date:

Good governance and Compliance

25 November 2020

**1. SUBJECT: APPOINTMENT OF SECTION 80 PORTFOLIO COMMITTEE CHAIRPERSONS**

**2. PURPOSE OF REPORT**

To inform Council on the reshuffling of the Mayoral Committee that has led to a change in the Section 80 Portfolio Committee chairpersons.

**3. DELEGATED AUTHORITY**

Executive Mayor appoints the chairpersons for the section 80 committees.

**4. EXECUTIVE SUMMARY**

The Executive Mayor, in terms of Section 60 of the Municipal Structures Act 117 of 1998 reshuffled her Mayoral Committee members effective from 1 November 2018. This led to a change in the Councilors that served as Chairpersons to the Section 80 Committees as well as the portfolios which they represent, and the introduction of two new S80 Committees.

The National and Provincial elections on 8 May 2019 led to the resignation of Cllr de Villiers, who was the Mayco member for Community Safety and Portfolio Chair for Community and Protection Services, and the position became vacant. Cllr Q Smit then also acted as Portfolio Chair of the particular committee. Cllr R Badenhorst was subsequently appointed as Mayco member for Community Safety.

On 11 November 2019 the Speaker and the Deputy Mayor both resigned, and the ex-Deputy Mayor was appointed as interim Speaker. On 14 November 2019 a new Deputy Mayor and Speaker were re-elected.

On 30 October 2020, the Speaker resigned, and the Deputy Mayor resigned at the Special Council meeting on 2 November 2020. At this special Council meeting, Cllr WC Petersen was elected as Speaker and Cllr N Jindela was elected as Deputy Mayor. [letter of resignation as **APPENDIX 1**]. The Executive Deputy Mayor is part of the Executive Mayoral Committee through the provisions of the legislation. The Executive Mayor herewith gives notice that she has appointed the Deputy Mayor, Cllr Jindela as the chairperson of Human Settlements. The other portfolio members are the same as before. The Speaker, Councillor Wilhelmina Petersen, does not form part of the Mayoral committee anymore since her election as Speaker.

**5. RECOMMENDATIONS**

that it BE NOTED that the Executive Mayor has appointed the following Mayco members as Chairpersons of the Section 80 Committees –

**Human Settlements**

Deputy Mayor Cllr Nyaniso Jindela

**Financial Services**

Cllr Patricia Crawley



**Parks, Open Spaces and Environment**

Cllr Xoliswa Mdemka

**Planning, Local Economic Development and Tourism**

Cllr Esther Groenewald

**Youth, Sports and Culture**

Cllr Manie Pietersen

**Rural Management**

Cllr Salie Peters

**Community and Protection Services**

Cllr Rikus Badenhorst

**Infrastructure Services**

Cllr Quintin Smit

**Corporate Services**

Cllr Aldridge Frazenburg

**6. DISCUSSION/CONTENT****6.1 BACKGROUND**

Council at an Urgent meeting held on 16 February 2017 appointed the Section 80 Committees in line with legislation. The Executive Mayor appointed her Mayoral Committee and Council noted the chairpersons of the respective committees in line with Section 80 of the Municipal Structures Act.

During October 2018 the Executive Mayor, in terms of Section 60 of the Municipal Structures Act, reshuffled the Mayoral Committee leading to a change in Chairpersons of the Mayoral Committee which led to a total restructuring and changing of the current S80 committees.

The National and Provincial elections on 8 May 2019 led to the resignation of Cllr de Villiers, who was the Portfolio Chair for Community and Protection Services, and the position became vacant. Cllr Q Smit then also acted as Portfolio Chair of the particular committee.

On 11 November 2019 the Speaker and the Deputy Mayor both resigned, and the then Deputy Mayor was appointed as interim Speaker. On 14 November 2019 a new Deputy Mayor and Speaker were re-elected.

**6.2 Discussion**

On 30 October 2020, the Speaker resigned, and the Deputy Mayor resigned at the Special Council meeting on 2 November 2020. At this special Council meeting, Cllr WC Petersen was elected as Speaker and Cllr N Jindela was elected as Deputy Mayor. In view of these changes the Executive Mayor appointed Cllr Jindela as the Chairperson of the Human Settlements Portfolio Committee in the place of Councilor Wilhelmina Petersen who is now the elected Speaker. It is herewith required that Council notes the change in chairpersons of the Section 80 Committees. The changes are herewith reported to Council for notification.

**6.3 FINANCIAL IMPLICATIONS**

As per the approved budget

**6.4 LEGAL IMPLICATIONS**

The recommendation complies with the relevant legislation.

**6.5 STAFF IMPLICATIONS**

No additional staff implications

**6.6 PREVIOUS / RELEVANT COUNCIL RESOLUTIONS:**

Item 13.2.1: 24<sup>th</sup> Council meeting held on 27 February 2019.

Item 18.1: 34<sup>th</sup> Council meeting held on 29 January 2020

**FOR FURTHER DETAILS CONTACT:**

<b>NAME</b>	Donovan Muller
<b>POSITION</b>	<i>Manager: Council Support</i>
<b>DIRECTORATE</b>	<i>Corporate Services</i>
<b>CONTACT NUMBERS</b>	021 808 8314
<b>E-MAIL ADDRESS</b>	<a href="mailto:Donovan.Muller@ Stellenbosch.gov.za">Donovan.Muller@ Stellenbosch.gov.za</a>
<b>REPORT DATE</b>	2020-11-18

# APPENDIX 1

Councillor N. Jindela

209 Aurora Flats

Stellenbosch

30 October 2020

The Office of the Municipal Manager

Stellenbosch Municipality

Re: Resignation as a Speaker

Good morning Ms Mettler, please find my letter as referred above.

Herewith I formally render my resignation as Speaker of the Stellenbosch municipal council, Effective as from the 31<sup>st</sup> of October 2020. I would like to thank the municipality for the opportunity And support I received from both councillors and officials during my time as a speaker.

Yours sincerely

N. Jindela

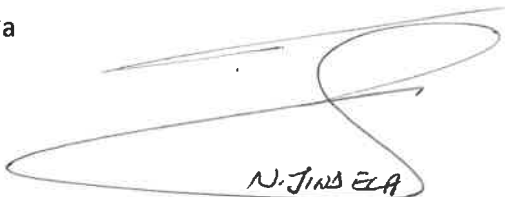

N. JINDELA

13.9	<b>POLICY AND PROCEDURES FOR WARD COMMITTEES, INCLUDING COVID-19 PROTOCOLS</b>
------	--

Collaborator No:

IDP KPA Ref No:

*Good Governance*

Meeting Date:

25 November 2020

**1. SUBJECT: POLICY AND PROCEDURES FOR WARD COMMITTEES, INCLUDING COVID19 PROTOCOLS**

**2. PURPOSE**

To submit the amended Policy and Procedures for Ward Committees, which include the relevant COVID-19 protocols for ward committee meetings (hereafter "Policy") to Council for approval.

**3. DELEGATED AUTHORITY**

Council approves policy.

**4. EXECUTIVE SUMMARY**

The Local Government Municipal Structures Act, 117 of 1998 prescribes amongst other that municipalities must devise a regulatory framework in respect of the procedure to elect members of a ward committee, the circumstances under which those members must vacate office and the frequency of meetings of ward committees.

To give effect to this stipulation a Policy and Procedures for Ward Committees was developed and adopted by Council in 2006. It was amended in 2010, 2012 and 2015 and was due for a review following the August 2016 local government elections.

The Policy was adopted by Council on 24 April 2019.

With the outbreak of the COVID-19 pandemic, ward offices had to close and ward committee meetings that depended on the ward office as a venue for meetings had to cease meeting if the ward committee was not able to meet on a virtual platform.

With the relaxation to level 2 of the COVID-19 levels, ward offices were allowed to re-open again on 1 September 2020, under the strict COVID-19 protocols. With this re-opening, ward committees in certain wards can resume physical meetings but must adhere to the strict COVID19 regulations and protocols.

The revised policy is now ready for adoption.

**5. RECOMMENDATIONS**

- (a) that Council adopts the revised Policy and Procedures for Ward Committees as per **APPENDIX 1**;
- (b) that this policy replaces all previous policies; and
- (c) that the policy be distributed to ward committees.

---

## 6. DISCUSSION / CONTENTS

### 6.1 Background

Council adopted the Policy and Procedures for Ward Committees on 29 November 2006, amended it at Council Meetings on 26 August 2010, 20 June 2012 and 28 October 2015. The new policy was adopted by Council on 24 April 2020.

### 6.2 Discussion

Section 73 of the Local Government Municipal Structures Act, 117 of 1998 prescribes that

*“A metro or local council must make rules regulating-*

*(a) the procedure to elect the subsection (2) (b) members of a ward committee, taking into account the need-*

*(i) for women to be equitably represented in a ward committee; and*

*(ii) for a diversity of interests in the ward to be represented.*

*(b) the circumstances under which those members must vacate office; and*

*(c) the frequency of meetings of ward committees”.*

In order to comply with the stipulation in the above-mentioned Act, Stellenbosch Municipality developed a Policy and Procedures for Ward Committees and adopted same during 2006 with various amendments over time as shown in paragraph 6.1 above.

The aim of the Policy is, inter alia, to deal with establishment and election of ward committees, terms of office, vacancies and dissolutions, powers and functions and conduct of members, ward committee meetings and administrative support, and public meetings.

The existing Policy has been thoroughly reviewed during 2017 with the assistance of a law expert and one of the Senior Legal Advisers in the employ of Council. Prior to the follow-up Ward Committee Summit the Draft Policy was further reviewed with the assistance of the legal expert referred to above a University of Stellenbosch academic – also a ward committee member.

During November 2018 a Ward Committee Summit was held where the Draft Revised Policy was discussed. The plenary requested more time to peruse the Policy. Consequently it was resolved that a follow-up Summit be held early in 2019 to finalise the Policy for submission to Council.

At the follow-up Ward Committee Summit held on 14 March 2019 the Draft Policy was presented to ward committee members. It was clear that ward committees needed a further opportunity to provide input into the draft document. It was subsequently resolved that ward committees be afforded a further opportunity to submit input by not later than 29 March 2019.

The input provided by a number of ward committees by the cut-off date was considered and incorporated into the Draft Revised Policy attached herewith as **APPENDIX 1**. This policy was adopted by Council on 24 April 2019.

This policy must now be amended to include the regulations and COVID19 protocols for ward committee meetings that takes place at ward offices.

### 6.3 Financial Implications

Per the approved budget.

**6.4 Legal Implications**

The recommendations in this report comply with the applicable legislation.

**6.5 Staff Implications**

This report has no additional staff implications for the Municipality.

**6.6 Previous / Relevant Council Resolutions:**

24 April 2019

**6.7 Risk Implications**

The risks are addressed in the item and policy adjustment

**6.8 Comments from Senior Management:**

None required

**ANNEXURES**

APPENDIX 1 – Amended Policy and Procedures for Ward Committees

**FOR FURTHER DETAILS CONTACT:**

<b>NAME</b>	Donovan Muller
<b>POSITION</b>	Manager: Councillor Support
<b>DIRECTORATE</b>	Corporate Services
<b>CONTACT NUMBERS</b>	021 808 8314
<b>E-MAIL ADDRESS</b>	<a href="mailto:Donovan.Muller@ Stellenbosch.gov.za">Donovan.Muller@ Stellenbosch.gov.za</a>
<b>REPORT DATE</b>	16 October 2020

# APPENDIX 1



# Stellenbosch Municipality

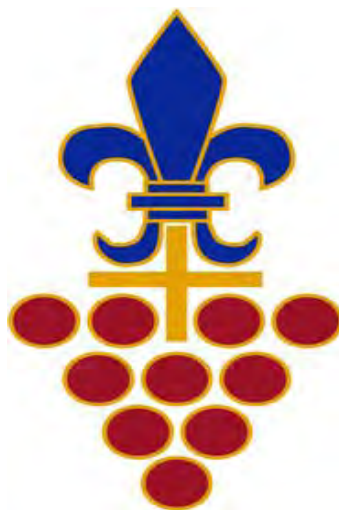

## Policy and Procedures For Ward Committees

**Revised Policy adopted** by Council on 24 April 2019

Revised and adopted by Council:

## TABLE OF CONTENTS

<b>Preamble and Definitions</b>	<b>4</b>
<b>1. Establishment</b>	<b>4</b>
<b>2. Status of Ward Committees</b>	<b>5</b>
<b>Chapter 1.</b>	
<b>3. Composition of Ward Committees</b>	<b>5</b>
<b>4. Decision on type of Ward Committees</b>	<b>6</b>
<b>5. Nomination</b>	<b>6</b>
<b>6. Election Criteria</b>	<b>6</b>
<b>7. Election Meeting</b>	<b>7</b>
<b>8. Election Procedure</b>	<b>7</b>
<b>9. Voting</b>	<b>8</b>
<b>Chapter 2</b>	
<b>10. Term of Office</b>	<b>9</b>
<b>11. Dissolution</b>	<b>9</b>
<b>12. Termination of Membership</b>	<b>9</b>
<b>13. Removal from Office</b>	<b>10</b>
<b>14. Filling of Vacancies</b>	<b>10</b>
<b>Chapter 3</b>	
<b>15. Powers and Functions of the Speaker</b>	<b>10</b>
<b>16. Powers and Functions of Ward Committees</b>	<b>11</b>
<b>17. Subcommittees</b>	<b>12</b>
<b>18. Conduct of Members</b>	<b>12</b>
<b>Chapter 4</b>	
<b>19. Chairperson</b>	<b>13</b>
<b>20. Purpose of Ward Committee Meetings</b>	<b>13</b>
<b>21. Quorum and Decisions</b>	<b>14</b>
<b>22. Procedures</b>	<b>14</b>
<b>23. Work Programme</b>	<b>15</b>
<b>24. Administrative Support</b>	<b>15</b>
<b>25. Budget</b>	<b>15</b>
<b>26. Accountability</b>	<b>16</b>
<b>27. Dispute Resolution</b>	<b>17</b>

**Chapter 5**

<b>28. Chairperson</b>	<b>17</b>
<b>29. Purpose of Ward/Public Meetings</b>	<b>17</b>
<b>30. Meeting Arrangements</b>	<b>17</b>

## Policy and Procedures for Ward Committees

Compiled in terms of the Local Government: Municipal Structures Act, 117 of 1998; Local Government: Municipal Systems Act, 32 of 2000 & 2005 DPLG Guidelines

### Preamble

WHEREAS Stellenbosch Municipality is committed to encouraging the involvement of communities and community organisations in its affairs;

WHEREAS Stellenbosch Municipality is a municipality with an Executive Mayoral System combined with a ward participatory system as set out in Section 9(d) of the Municipal Structures Act;

WHEREAS the Council has resolved in terms of Section 72(2) of the Act to adopt the ward participatory system;

IT IS THEREFORE RESOLVED by the Council of Stellenbosch Municipality as follows:-

### Definitions

In this Policy and Procedures, a word or expression has the meaning assigned to it in applicable national legislation; otherwise it has the meaning as defined below:

“**the Act**” means the Local Government: Municipal Structures Act, 1998 (Act 117 of 1998);

“**election officer**” means the person in charge of the election of ward committee members at an election meeting, which person shall be an official of the municipality or an impartial person appointed by the municipality for this purpose;

“**geographical area**” means a portion of the ward to be served by a ward committee member or more than one ward committee member eg a block of streets

“**nominee**” means a person, nominated in terms of Clause 5 for election to the Ward Committee by a registered voter residing in that ward;

“**out of pocket expenses**” means the payment of out of pocket expenses to members of ward committees in respect of participation by ward committee members in the activities of the ward committees as contemplated in Clause 73(5)(c) of the Act; , “**resident**” means a resident of the ward for which the ward committee was established;

## CHAPTER 1 ESTABLISHMENT AND ELECTION

### 1. Establishment

With effect from a date set by the Municipality, ward committees will be established for all the wards.

## **2. Status of ward committees**

- (1) The object of a ward committee is to enhance participatory democracy in local government.
- (2) A ward committee:
  - (a) is an advisory body;
  - (b) is a representative structure of the ward;
  - (c) is an independent committee of the community in a ward;
  - (d) is impartial and perform its functions without fear, favour or prejudice;
  - (e) is not politically orientated;
  - (f) as a representative structure of the community is accountable to the community; and
  - (g) is an integrative umbrella body responsible for coordination of ward developmental initiatives, promotion of accountability and social cohesion.

## **3. Composition of ward committees**

- (1) A ward committee will comprise of the ward councillor representing that ward in the Council and not more than 10 other persons elected according to Clauses 6 to 10.
- (2) Gender equity and diversity of interests will be pursued by the election officer. This will be done by drawing the attention of the voters at the start of an election meeting to the importance of –
  - (a) striving for an equal representation of men and women on a ward committee;
  - (b) having representatives for different communities within the ward on the ward committee in the case of a geographical representation system.
- (3) The municipality shall appoint ward administrators to fulfil the administrative and /or secretarial duties of the ward committee.
- (4) A ward councillor may delegate in writing the chairing of a meeting in his/her absence to a proportional representation councillor or any member of the ward committee.
- (5) A ward committee may extend a standing invitation to a maximum of two individuals which they feel will contribute to a better representivity of the committee, as observers to the ward committee.
- (6) The observers mentioned in Sub-Clause (5) above will have no voting rights during ward Committee meetings.

#### 4. Decision on type of ward committee

- (1) When a new ward committee is to be established, the municipality must determine beforehand whether the particular ward warrants a single election following the geographical representation system taking into account the diversity of communities as well as the geography of that ward.
- (2) The Administration of the Municipality, after consultation with ward councillors, is to recommend to council what type of election system to be used for each ward.
- (3) In the case of a geographical representation system the municipality, in consultation with the ward councillors, must determine beforehand how many ward committee members will be representing each geographical area, taking into consideration the pro-rata numbers of registered voters in each voting district.
- (4) The ward councillor must determine the number of the geographical blocks for the ward taking into consideration the distribution of registered voters in the area.

#### 5. Nomination

- (1) Before the municipality calls for nominations for a general election of ward committees, an information campaign must be undertaken to inform the public and councillors on all aspects of the election.
- (2) In the case of a geographical representation system, only nominations in respect of and made by a registered individual residing in the particular geographical area will be valid.
- (3) The municipality must –
  - (a) Publish a call for nominations for candidates at least 45 days before close of nominations for ward committee elections in one or more of the local newspapers in the Stellenbosch Municipal area; and
  - (b) Advertise the call for nominations on notice boards in municipal buildings and municipal libraries for a period of at least 30 days.
- (5) A nomination must be accompanied by –
  - (a) a written acceptance of the nomination by the nominee in the prescribed format;
  - (b) a copy of the ID or ID card of both the proposer and nominee;

#### 6. Election criteria

To be elected as a member of a ward committee, a person -

- (a) must be a registered voter in the ward concerned;
- (b) may not be a member of the Stellenbosch Town Council;

- (c) may not be in the full-time employment of the Stellenbosch Municipality;
- (d) may not be in arrears to the Municipality for rates and service charges for a period of more than 3 months on and after the date of nomination;
- (e) may not be someone who, after February 1997, have been convicted of an offence and sentenced to imprisonment without the option of a fine for a period of not less than twelve months;
- (f) may not be someone of unsound mind who have been declared so by a competent court; or
- (g) may not be an unrehabilitated insolvent.

## **7. Election meeting**

- (1) Elections will be held according to the type of election system determined by council for each ward in terms of Clause 4 above.
- (2) On determining the election meeting venue or venues in the case of separate meetings, the municipality must take into account, *inter alia*:
  - (a) the input of ward councillors concerned;
  - (b) distances for voters to travel;
  - (c) the needs of minority or vulnerable groups to be accommodated on the ward committee; and
  - (d) the existence or not of separate communities within the ward with dissimilar needs.
- (3) After the nominations have closed, the municipality must –
  - (a) convene an election meeting for and within each ward after confirmation of the election date with the relevant ward councillor, and
  - (b) make public the date, time and place of a ward election meeting by way of official notice in local newspapers in all the official languages of the province; as well as other means of public communication as determined by council.
- (4) Only residents who are registered voters in the ward concerned may attend and vote at the meeting. This does not exclude municipal officials and members of the media to attend the meeting without the right to vote.
- (5) The ward election meeting is chaired by the election officer.
- (6) Provision must be made for the illiterate, where applicable.

## **8. Election procedure**

- (1) The ward councillor, if present, may welcome the voters and the candidates and must then take a seat amongst those present at the meeting and refrain from any interference with the proceedings.

- (2) The election officers will then take control of the voting process and explain the procedure to be followed.
- (3) the nominees are –
  - (a) introduced by the election officer, and
  - (b) may then be allocated, on an even basis, time to address the meeting.
- (4) After nominees were introduced, the election officer will call for a vote on the nominees within that geographical area.
- (5) If only one person was nominated, the election officer must declare that person elected.
- (6) The election officer must declare elected the nominee who receives a majority of the votes (50% plus one) cast.
- (7) If no nominee receives a majority of the votes cast, a second vote is taken on the three nominees that received the highest number of votes in the first vote.
- (8) If no nominee receives a majority of the votes cast in the second vote, a third vote is taken on the two nominees that received the highest number of votes in the second vote.
- (9) If the two nominees have exactly the same number of votes after the process in Sub-Clause (8) above, the election officer will determine the elected person by the draw of lots.
- (10) Once all vacancies have been filled, the election officer must indicate to those present their right to appeal.
  - (a) Any such appeal must be lodged with the Office of the Speaker within seven (7) days of the election.
  - (b) Appeals will be dealt with by an independent person appointed for this purpose by the Speaker and agreed to by the appellant. The findings of the independent person will be binding.
- (11) The ward councillor may at this point in time take control of the meeting to thank everybody present, congratulate the successful candidates and to close the meeting; should he/she so wish.

## **9. Voting**

- (1) Each community member present may cast one vote for one nominee residing in his/her geographical area
- (2) Voting shall be by ballot paper unless 75% or more of the voters decide to vote by show of hands. This may be determined for the meeting as a whole or for each geographical area separately.



- (3) Where voting is done by show of hands, the nominees for each geographical area will leave the hall for the duration of the election with respect to that geographical area.
- (4) The ward councillor may vote for a nominee in his/her geographical area. .
- (5) The ward councillor may not before or during the election meeting influence or campaign for the election of ward committee members.

## **CHAPTER 2**

### **TERMS OF OFFICE, VACANCIES AND DISSOLUTION**

#### **10. Term of office**

- (1) The term of office for a ward committee will run concurrently with that of the Council up to the day of the next municipal elections.
- (2) Members of a ward committee will vacate office when a new Council is declared elected
- (3) The vacation of office by the ward councillor does not affect the term of office of the 10 members elected in accordance with Clauses 5 to 9.
- (4) A ward committee member may be re-elected, subject to the above sub-Clauses.

#### **11. Dissolution**

- (1) The Council may, by notice addressed to the ward committee, dissolve the ward committee:
  - (a) when it fails to meet three consecutive times as per schedule of meetings;
  - (b) when a majority of members, in terms of a vote taken at a ward committee meeting, recommends to council that the committee be dissolved , or
  - (c) when maladministration, fraud, corruption or any serious malpractice has occurred or is occurring in a ward committee.
- (2) The Council must give prior notice to the ward committee of the intention to dissolve a ward committee subject to a right to reply within 14 days.

#### **12. Termination of membership**

The membership of a ward committee member will be terminated if that member:

- (a) resigns in writing;
- (b) is no longer qualified, in terms of Clause 6 above, to be a member of a ward committee;
- (c) is removed from office by the Speaker in terms of Clause 13; or

- (d) dies.

### **13. Removal from office**

The Speaker can remove a member of a ward committee from office if that member -

- (a) fails to attend three consecutive meetings without obtaining leave of absence from the ward committee;
- (b) deliberately fails to adhere to meeting procedures or is guilty of gross misconduct during ward committee meetings;
- (c) is involved in proven and malicious activities solely to undermine the authority of the Council or the ward councillor, or
- (d) is engaged in corruption or deliberately fails to disclose material conflict of interest.

### **14. Filling of vacancies**

- (1) The Speaker must fill the vacancy by declaring as elected the person who received the second highest number of votes in the geographical area concerned during the election held in terms of Clause 8.
- (2) If nobody can be declared elected in terms of sub-Clause (1) above, the ward committee may, by means of an information campaign in the respective geographical area, call for qualifying nominations from that area, consider the received nominations and by a majority vote of the members present, fill the vacancy through a process of co-option.
- (3) The intention to fill a vacancy through a process of co-option must be placed on the ward committee's agenda beforehand, which agenda must be circulated to members at least 7 days before the meeting.
- (4) Geographical representation of the member, who vacated his /her position, must be taken into account when filling a vacancy.
- (5) A person co-opted as a ward committee member must comply with the criteria stipulated in Clause 6 above.

## **CHAPTER 3**

### **POWERS AND FUNCTIONS AND CONDUCT OF MEMBERS**

#### **15. The role of the Speaker of Council**

The Speaker of Council :

- (1) is the patron/custodian of Ward Committees;
- (2) must ensure that ward participatory structures are established in line with the set guidelines and applicable legislation;

- (3) must in collaboration with Ward Councillors regulate and monitor the frequency of ward committee and community report back meetings;
- (4) must through his/her office ensure functionality of ward committees;
- (5) must ensure that the local government environment is conducive to active citizen participation in governance at local level;
- (6) must ensure ongoing training and capacity building programmes; and
- (7) set deadlines for submission of ward committee reports.

## **16. Powers and functions of ward committees**

- (1) A ward committee may make recommendations on any matter affecting its ward to the ward councillor, or through the ward councillor to the Council, the Mayoral Committee or to the Executive Mayor.
- (2) The following functions and powers are delegated to ward committees by the Council in terms of Clause 59 of the Municipal Systems Act:
  - (a) to serve as an official specialised participatory structure in the municipality.
  - (b) to create formal unbiased communication channels as well as co-operative partnerships between the community and the Council. This will be achieved as follows:
    - (i) Advise and make recommendations to the ward councillor on matters and policy affecting the ward;
    - (ii) Assist the ward councillor in identifying challenges and needs of residents;
    - (iii) Disseminate information in the ward concerning municipal affairs such as the budget, integrated development planning, performance management system (PMS), service delivery options and municipal properties;
    - (iv) Receive queries and complaints from residents concerning municipal service delivery, communicate it to the ward councillor and through him/her to Council ;
    - (v) Ensure constructive and harmonious interaction between the municipality and community through the use and co-ordination of ward residents meetings and other community development forums; and
    - (vi) Interact with other forums and organisations on matters affecting the ward.
  - (c) To serve as a mobilising agent for community action within the ward. This may be achieved as follows:
    - (i) Attend to all matters that affect and benefit the community;
    - (ii) Act in the best interest of the community; and
    - (iii) Ensure the active participation of the community in –

- (aa) service payment campaigns;
  - (bb) the integrated development planning process;
  - (cc) the municipality's budgetary process;
  - (dd) decisions about the provision of municipal services, and
  - (ee) decisions about by-laws;
- (d) No executive powers will be delegated to ward committee members;
- (e) A ward committee majority may express dissatisfaction to the Speaker in writing on the non-performance of a ward councillor.

### **17. Subcommittees**

- (1) A ward committee may establish one or more subcommittees necessary for the performance of its functions and involve organisations more broadly.
- (2) A ward committee must –
- (a) appoint the members of such a sub-committee;
  - (b) appoint the chairperson of such a sub-committee from amongst its members, and
  - (c) determine the function of such a sub-committee.
- (3) The ward committee and sub-committees may meet together as a ward forum for major discussions.
- (4) Stakeholders in the ward may apply to the ward committee to participate in sub-committees that are relevant to their fields of interest and to their day-to-day functioning as a sector.

### **18. Conduct of members**

A member of the ward committee:

- (a) Must perform the functions of the committee in good faith and without fear, favour or prejudice.
- (b) May not use the position or privileges of a member for private gain, or to improperly benefit another person.
- (c) May not act in any other way that compromises the credibility, impartiality, independence or integrity of the committee.
- (d) Must adopt the principle of accountability to the community and Council regardless of political affiliation.
- (e) Must be accessible for the community and ensure that all role players can relate to the process and the issues at hand and are able to make their input into the processes of the committee.

- (f) Must adopt the principle of transparency to promote openness, sincerity and honesty among all the role-players in a participative process and promote trust and respect for the integrity of each role-player and a commitment by all to the overriding objectives of the process in the interest of the common good.
- (g) Must recognise diversity with empathy towards the differences associated with race, gender, religion, ethnicity, language, age, economic status and sexual orientation;
- (h) Must consider all views and opinions in the process of community participation. Special effort should be made to include previously disadvantaged persons and groups, including women and youth in the activities of the ward committee.
- (i) Must provide an apology with a valid reason to the chairperson of the committee or the Ward Administrator if a meeting cannot be attended.

## **CHAPTER 4**

### **WARD COMMITTEE MEETINGS**

#### **19. Chairperson**

- (1) Subject to Clause 3(4) above, ward committee meetings are convened and chaired by the ward councillor.
- (2) Members of the ward committee must submit substantive items to be discussed, well in advance to the chairperson.
- (3) The chairperson will be responsible to prepare an agenda for ward committee meetings.
- (4) The chairperson determines when and where a ward committee meets, subject to Sub-Clause (5) below.
- (5) A ward committee should meet on a monthly basis but must meet at least quarterly.

#### **20. Purpose of ward committee meeting**

The purpose of the ward committee meetings is:

- (a) for ward committee members to raise, formulate and table matters affecting the ward;
- (b) for the ward councillor to report on –
  - (i) matters decided by the Council;
  - (ii) initiatives, information, campaigns and programmes of the Council,
- (c) To discuss complaints received by ward committee members on municipal service delivery in the ward; and
- (d) To formulate views and action plans on the above matters.

**21. Quorum and decisions**

- (1) 50% plus one of the serving ward committee members must be present before a vote may be taken on any matter.
- (2) A ward committee shall endeavour to adopt its decisions on the basis of consensus.
- (3) If consensus on any matter cannot be achieved, such matter may be determined by a supporting vote of at least the majority of the members with voting rights.

**22. Procedures**

- (1) A ward committee with a supporting vote of the majority of its serving members may determine its own procedures subject to any directions of the chairperson.
- (2) Meetings of a ward committee are normally open to the public.
- (3) Due to the coronavirus pandemic, ward committees are encouraged to meet on a virtual platform to ensure compliance with the COVID19 regulations. Where it is not possible for a ward committee to meet on a virtual platform, and the ward committee meetings must be held in the ward office or another hall or boardroom, there must be strict adherence to the following protocols at each ward committee meeting:
  - (a) the venue must be sanitised before and after the meeting, including furniture, surfaces, door handles, etc;
  - (b) ensure the venue is large enough to ensure the correct social / physical distancing;
  - (c) an attendance register must be completed by all attendees at the meeting;
  - (d) all attendees must wear a mask: no mask, no entry to the meeting;
  - (e) masks must be worn throughout the entire meeting;
  - (f) before the commencement of the meeting, attendees must sanitise their hands, have their temperature taken and complete the daily screening sheet for the respective meeting [screening sheet attached];
  - (g) the screening sheet must be electronically filed after each meeting.
  - (h) adherence to the two 1,5 – 2 metre social or physical distancing must be adhered to.
  - (i) if a ward committee member shows any symptoms or has flu-like symptoms, the person must stay at home.
  - (j) it is the duty of the ward councillor to ensure the protocols are at all times adhered to when meetings, including ward committee meetings are held.

**23. Work programme**

The Ward committee:

- (a) Must submit a programme with specific outputs of work for one year to the office of the Speaker or other designated political functionary in July of each year;
- (b) Must perform the functions as set out to achieve and indicated in the work programme -
  - (i) on own initiative;
  - (ii) on request by the ward councillor;
  - (iii) on request by the Speaker or other designated political functionary;
  - (iv) in accordance with priorities and reasonable time frames determined by the Speaker or other designated political functionary.

**24. Administrative support**

- (1) The municipality must make administrative and secretarial arrangements to enable ward committees to perform their functions and exercise their powers effectively.
- (2) The municipality may put in place conditions, such as periods of notice of meetings, in order to organise administrative and secretarial support to the ward committee.
- (3) In the case where the Municipal Manager receives correspondence from a ward committee, he/she must give feedback to the ward councillor concerned (with a copy to the Executive Mayor) on the information or action required within 14 days of receipt of the correspondence.
- (4) Ward committees are entitled by prior arrangement to the free use of venues in municipal buildings in order to hold official meetings.

**25. Budget**

- (1) Members of ward committees will be reimbursed for out of pocket expenses as contemplated in Clause 25 (2) (a)(i) below.
- (2) The Municipality will annually budget for the reimbursement of –
  - (a) Out of pocket expenses for members of ward committees in respect of their participation in ward committees subject to the following criteria as approved by Council on 20 June 2012 and revised by Council on 28 October 2015:
    - (i) that **fourteen (14)** ward committee meetings which will comprise of **one (1)** ward committee meetings every month and **one (1)** open public meeting every semester (every six (6) months) be identified and approved by the

ward committee as paid meetings and that each serving member present at these meetings, be paid an out of pocket allowance of **R350.00 per meeting (R350 x 14 = R4900.00)**. Payment of out of pocket allowances will be made quarterly;

- (ii) the reimbursement amount will be paid to the ward committee members in person and not to organisations that he/she represents;
- (iii) that reimbursements only be paid on verification of attendance register of meetings attended and that reimbursements will only be electronically transferred to the bank account of the relevant ward committee member(s);
- (iv) that ward committee members may elect not to be reimbursed;

## 26. Accountability

The ward councillor must -

- (a) ensure that full and proper records are kept of the minutes of ward committee meetings.
- (b) ensure that the committee's available resources are properly safeguarded and used in the most effective and efficient way.
- (c) ensure that all statutory measures applicable to the committee are complied with.
- (d) ensure that all recommendations and comments made by the ward committee are formalised and submitted to the Office of the Speaker or other designated political functionary for presentation to Council or conveyed timeously to the appropriate external decision making authority.
- (e) report a view adopted by the ward committee to the Council but may indicate his/her agreement with the view in the report.
- (f) ensure the production of a progress report on major achievements and areas of failure, with reasons, within two months after the end of the financial year.
- (g) submit the progress report to the Speaker or other designated political functionary for a review of the performance of the committee.
- (h) implement any corrective measures to ensure effective and efficient performance of the committee as suggested by the Speaker or other designated political functionary.



**27. Dispute resolution**

The following mechanisms are recommended when disputes arise within ward committees:

- (a) Every effort should be made to deal with disputes.
- (b) When a dispute arises, the ward councillor should appoint a person or persons, the maximum being two, to attempt and resolve the dispute through mediation.
- (c) If the attempt at mediation fails, the matter is then submitted to the ward councillor who should arbitrate, provided that the matter does not involve the councillor and the majority of the members of the committee.
- (d) If the majority of committee members remain aggrieved, the matter should be taken to the Council through a channel decided upon by Council or through the Office of the Speaker or other designated political functionary. This should be avoided as far as possible.

**CHAPTER 5****PUBLIC MEETINGS (WARD MEETINGS)****28. Chairperson**

- (1) Public meetings (ward meetings) are chaired by the ward councillor. A ward councillor may delegate in writing the chairing of the meeting to a proportional representation councillor or any member of the ward committee.
- (2) The ward councillor in consultation with the ward committee determine when and where the meeting will be held, subject to Sub-Clause (3).
- (3) A public meeting must be held at least twice per calendar year.

**29. Purpose of ward/public meetings**

Public meetings are mainly held in order -

- (a) To register the concerns and inputs of the community with regard to service delivery, general development of the community, disaster management and any other municipal concern the community may have; and
- (b) To report back to the public on issues that affects it.

**30. Meeting arrangements**

- (1) If the committee decides to hold a public meeting it may publish a notice in a newspaper circulating in the area concerned, stating the time, date and place of the meeting and inviting the public to attend the meeting.
- (2) The scheduled date, time and place of the public meeting should be convenient so as to encourage the greatest number of people to attend. The venue -

- (a) Must be in a well known place;
  - (b) Must be easily accessible and where possible, also disabled-friendly; and
  - (c) Must be large enough to accommodate all people present.
- (3) When the committee publishes a notice, it must convey, where appropriate, by electronic media or other appropriate means of communication, such as direct mail and posters or notices in key areas such as clinics, schools, bus stops and libraries, the contents of the notice in the area concerned.
- (4) Due to the coronavirus pandemic, public meetings must adhere to the totals of people allowed per venue as per the level 1 regulations. At the meeting, there must be strict adherence to the following protocols:
- (a) the venue must be sanitised before and after the meeting, including furniture, surfaces, door handles, etc;
  - (b) ensure the venue is large enough to ensure the correct social / physical distancing, as well as adherence to the number of persons allowed in a venue as per the level 1 regulations;
  - (c) an attendance register must be completed by all attendees at the meeting;
  - (d) all attendees must wear a mask: no mask, no entry to the meeting;
  - (e) masks must be worn throughout the entire meeting;
  - (f) before the commencement of the meeting, attendees must sanitise their hands, have their temperature taken and complete the daily screening sheet for the respective meeting [screening sheet attached];
  - (g) the screening sheet must be electronically filed after each meeting.
  - (h) adherence to the two 1,5 – 2 metre social or physical distancing must be adhered to.
  - (i) if a member of the public shows any symptoms or has flu-like symptoms, the person must stay at home.
  - (j) it is the duty of the ward councillor to ensure the protocols are at all times adhered to when meetings, including ward committee meetings are held.
- (5) At the public meeting a representative of the committee must –
- (a) explain the meeting procedures, such as adoption of agenda and time allowed for questions;
  - (b) explain the issues the committee has to consider, including any options open to the committee;
  - (c) allow members of the public attending the meeting to present their views on these issues;
  - (d) answer relevant questions;
  - (e) keep minutes of the meeting and inform the public that ward committee meeting and public meeting minutes are public

documents, and that the community has access to these documents and may make copies at their own cost; and

- (f) give feedback on previous issues, including reasons if there is a lack of progress.





DAY DATE	18	19	20	21	22	23	24	25	26	27	28	29	30	31
<b>TEMPERATURE</b>														
<b>Do you have any of the following symptoms</b>														
• <b>Cough</b>	<input type="checkbox"/> Y <input type="checkbox"/> N	<input type="checkbox"/> Y <input type="checkbox"/> N	<input type="checkbox"/> Y <input type="checkbox"/> N	<input type="checkbox"/> Y <input type="checkbox"/> N	<input type="checkbox"/> Y <input type="checkbox"/> N	<input type="checkbox"/> Y <input type="checkbox"/> N	<input type="checkbox"/> Y <input type="checkbox"/> N	<input type="checkbox"/> Y <input type="checkbox"/> N	<input type="checkbox"/> Y <input type="checkbox"/> N	<input type="checkbox"/> Y <input type="checkbox"/> N	<input type="checkbox"/> Y <input type="checkbox"/> N	<input type="checkbox"/> Y <input type="checkbox"/> N	<input type="checkbox"/> Y <input type="checkbox"/> N	<input type="checkbox"/> Y <input type="checkbox"/> N
• <b>Shortness of breath</b>	<input type="checkbox"/> Y <input type="checkbox"/> N	<input type="checkbox"/> Y <input type="checkbox"/> N	<input type="checkbox"/> Y <input type="checkbox"/> N	<input type="checkbox"/> Y <input type="checkbox"/> N	<input type="checkbox"/> Y <input type="checkbox"/> N	<input type="checkbox"/> Y <input type="checkbox"/> N	<input type="checkbox"/> Y <input type="checkbox"/> N	<input type="checkbox"/> Y <input type="checkbox"/> N	<input type="checkbox"/> Y <input type="checkbox"/> N	<input type="checkbox"/> Y <input type="checkbox"/> N	<input type="checkbox"/> Y <input type="checkbox"/> N	<input type="checkbox"/> Y <input type="checkbox"/> N	<input type="checkbox"/> Y <input type="checkbox"/> N	<input type="checkbox"/> Y <input type="checkbox"/> N
• <b>Sore throat</b>	<input type="checkbox"/> Y <input type="checkbox"/> N	<input type="checkbox"/> Y <input type="checkbox"/> N	<input type="checkbox"/> Y <input type="checkbox"/> N	<input type="checkbox"/> Y <input type="checkbox"/> N	<input type="checkbox"/> Y <input type="checkbox"/> N	<input type="checkbox"/> Y <input type="checkbox"/> N	<input type="checkbox"/> Y <input type="checkbox"/> N	<input type="checkbox"/> Y <input type="checkbox"/> N	<input type="checkbox"/> Y <input type="checkbox"/> N	<input type="checkbox"/> Y <input type="checkbox"/> N	<input type="checkbox"/> Y <input type="checkbox"/> N	<input type="checkbox"/> Y <input type="checkbox"/> N	<input type="checkbox"/> Y <input type="checkbox"/> N	<input type="checkbox"/> Y <input type="checkbox"/> N
• <b>Redness of eyes</b>	<input type="checkbox"/> Y <input type="checkbox"/> N	<input type="checkbox"/> Y <input type="checkbox"/> N	<input type="checkbox"/> Y <input type="checkbox"/> N	<input type="checkbox"/> Y <input type="checkbox"/> N	<input type="checkbox"/> Y <input type="checkbox"/> N	<input type="checkbox"/> Y <input type="checkbox"/> N	<input type="checkbox"/> Y <input type="checkbox"/> N	<input type="checkbox"/> Y <input type="checkbox"/> N	<input type="checkbox"/> Y <input type="checkbox"/> N	<input type="checkbox"/> Y <input type="checkbox"/> N	<input type="checkbox"/> Y <input type="checkbox"/> N	<input type="checkbox"/> Y <input type="checkbox"/> N	<input type="checkbox"/> Y <input type="checkbox"/> N	<input type="checkbox"/> Y <input type="checkbox"/> N
• <b>Additional factors</b>	<input type="checkbox"/> Y <input type="checkbox"/> N	<input type="checkbox"/> Y <input type="checkbox"/> N	<input type="checkbox"/> Y <input type="checkbox"/> N	<input type="checkbox"/> Y <input type="checkbox"/> N	<input type="checkbox"/> Y <input type="checkbox"/> N	<input type="checkbox"/> Y <input type="checkbox"/> N	<input type="checkbox"/> Y <input type="checkbox"/> N	<input type="checkbox"/> Y <input type="checkbox"/> N	<input type="checkbox"/> Y <input type="checkbox"/> N	<input type="checkbox"/> Y <input type="checkbox"/> N	<input type="checkbox"/> Y <input type="checkbox"/> N	<input type="checkbox"/> Y <input type="checkbox"/> N	<input type="checkbox"/> Y <input type="checkbox"/> N	<input type="checkbox"/> Y <input type="checkbox"/> N
<b>Does any of your immediate family members have any of the symptoms</b>	<input type="checkbox"/> Y <input type="checkbox"/> N	<input type="checkbox"/> Y <input type="checkbox"/> N	<input type="checkbox"/> Y <input type="checkbox"/> N	<input type="checkbox"/> Y <input type="checkbox"/> N	<input type="checkbox"/> Y <input type="checkbox"/> N	<input type="checkbox"/> Y <input type="checkbox"/> N	<input type="checkbox"/> Y <input type="checkbox"/> N	<input type="checkbox"/> Y <input type="checkbox"/> N	<input type="checkbox"/> Y <input type="checkbox"/> N	<input type="checkbox"/> Y <input type="checkbox"/> N	<input type="checkbox"/> Y <input type="checkbox"/> N	<input type="checkbox"/> Y <input type="checkbox"/> N	<input type="checkbox"/> Y <input type="checkbox"/> N	<input type="checkbox"/> Y <input type="checkbox"/> N
<b>Have you or your immediate family travelled (funerals /gathering/ Sick person/visit doctor) during last 2 weeks</b>	<input type="checkbox"/> Y <input type="checkbox"/> N	<input type="checkbox"/> Y <input type="checkbox"/> N	<input type="checkbox"/> Y <input type="checkbox"/> N	<input type="checkbox"/> Y <input type="checkbox"/> N	<input type="checkbox"/> Y <input type="checkbox"/> N	<input type="checkbox"/> Y <input type="checkbox"/> N	<input type="checkbox"/> Y <input type="checkbox"/> N	<input type="checkbox"/> Y <input type="checkbox"/> N	<input type="checkbox"/> Y <input type="checkbox"/> N	<input type="checkbox"/> Y <input type="checkbox"/> N	<input type="checkbox"/> Y <input type="checkbox"/> N	<input type="checkbox"/> Y <input type="checkbox"/> N	<input type="checkbox"/> Y <input type="checkbox"/> N	<input type="checkbox"/> Y <input type="checkbox"/> N
<b>If response yes to above, please provide details</b>	<input type="checkbox"/> Y <input type="checkbox"/> N	<input type="checkbox"/> Y <input type="checkbox"/> N	<input type="checkbox"/> Y <input type="checkbox"/> N	<input type="checkbox"/> Y <input type="checkbox"/> N	<input type="checkbox"/> Y <input type="checkbox"/> N	<input type="checkbox"/> Y <input type="checkbox"/> N	<input type="checkbox"/> Y <input type="checkbox"/> N	<input type="checkbox"/> Y <input type="checkbox"/> N	<input type="checkbox"/> Y <input type="checkbox"/> N	<input type="checkbox"/> Y <input type="checkbox"/> N	<input type="checkbox"/> Y <input type="checkbox"/> N	<input type="checkbox"/> Y <input type="checkbox"/> N	<input type="checkbox"/> Y <input type="checkbox"/> N	<input type="checkbox"/> Y <input type="checkbox"/> N

NOTE: If response is yes to any of the questions the employee must be isolated and the Supervisor is to seek advice from your line manager before allowing the employee to enter the workplace or requested to return home or visit a doctor hospital.

14.	<b>CONSIDERATION OF NOTICES OF QUESTIONS AND NOTICES OF MOTIONS RECEIVED BY THE SPEAKER</b>
14.1	<b>QUESTION BY COUNCILLOR F ADAMS: BREAKDOWN: SUBSIDIZED AND GAP HOUSING</b>

A Notice of a Question, dated 2020-10-27, was received from Councillor F Adams regarding breakdown: subsidized and GAP Housing.

The said Question is attached as **APPENDIX 1** and the appropriate response as **APPENDIX 2**.

**FOR CONSIDERATION**

**FOR FURTHER DETAILS CONTACT:**

<b>NAME</b>	Geraldine Mettler (Ms)
<b>POSITION</b>	<i>Municipal Manager</i>
<b>DIRECTORATE</b>	<i>Office of the Municipal Manager</i>
<b>CONTACT NUMBERS</b>	<i>021 808-8025</i>
<b>E-MAIL ADDRESS</b>	<i>Municipal.Manager@stellenbosch.gov.za</i>
<b>REPORT DATE</b>	<i>November 2020</i>

# APPENDIX 1

MUNICIPALITY - MUNISIPALITEIT  
 STELLENBOSCH  
 27 OCT 2020  
 OFFICE OF THE SPEAKER



CONTACT: [oackcity2010@yahoo.com](mailto:oackcity2010@yahoo.com)  
 P.O BOX 12445  
 DIE BOORD  
 7613

Democratic New Civic Association

“Without Prejudice”

28 August 2020

For attention: The Speaker

Stellenbosch Municipality

MUNICIPALITY - MUNISIPALITEIT  
 STELLENBOSCH  
 27 OCT 2020  
 OFFICE OF THE SINGLE WHIP

**Re: Question.**

I hereby submit the following question to serve at the ~~September~~ <sup>November</sup> 2020 Council meeting.

**Motivation/background**

1. I refer to the delivering of houses and the challenges with the long outstanding waiting list within WCO 24. We witness every year with the annual IDP process that the majority of wards first priorities is housing, as well as land.

**Question:**

- a. I request a breakdown how many subsidized (RDP) and GAP houses were built since 2010 within WCO 24, Stellenbosch.

I request the Manager for New Housing to answer in writing.

Clr. Franklin Adams

**Aluta Continua**

MUNICIPALITY - MUNISIPALITEIT  
 STELLENBOSCH  
 28 AUG 2020  
 OFFICE OF THE SINGLE WHIP



# **APPENDIX 2**



# MEMORANDUM

*Office of the Municipal Manager  
Kantoor van die Munisipale Bestuurder*

---

**TO : SPEAKER**  
**FROM : MUNICIPAL MANAGER**  
**DATE : 10 NOVEMBER 2020**  
**RE : REPLY TO QUESTIONS IN TERMS OF SECTION 35 OF THE  
STANDING RULES AND ORDER FOR THE MEETINGS OF COUNCIL**

---

Dear Speaker

With reference to the question received from the DNCA, Councillor F Adams submitted in terms of Section 35 of the Standing Rules and Order for the meetings of council, received by my office.

## **QUESTION**

- a) "I request a breakdown how many subsidized (RDP) and GAP houses were built since 2010 within WC024, Stellenbosch?"

## **RESPONSE**

As previously indicated, responses are drafted from the Office of the Municipal Manager. Councillors cannot instruct municipal officials to respond to questions.

Housing opportunities from 2010 until 2020 are as follow:

<b>PROJECT NAME</b>	<b>HOUSES</b>	<b>SERVICE SITES</b>
<b>Klapmuts</b>		
Erf 342	831 subsidised houses	831 service sites
Erf 2124, Koelpark	99 subsidised houses	99 service sites
Farm 744/3, Klapmuts	52 subsidised houses	52 service sites
Mandela City	221 TRA	259 service sites
<b>Cloetesville</b>		
The Steps/Orlean Lounge	161 rectifications	
Smartie Town	106 rectifications	
<b>Kayamandi</b>		
Watergang Phase 1	100 subsidised houses	100 service sites
Watergang Phase 1	187 subsidised houses	193 service sites
Watergang Phase 1	106 subsidised houses	106 service sites
Watergang Phase 2&3	277 TRA	296 service sites
<b>Vlottenburg</b>		
Digteby	20 subsidised houses	20 services sites
Longlands		144 service sites in progress
<b>Idas Valley</b>		
Erf 11330	113 GAP	113 services sites
Erf 11330	87 subsidised houses	89 services sites

<b>Jamestown</b>		
Farm 527	162 subsidised houses	162 service sites
<b>Franschhoek</b>		
Mooiwater 301	231 subsidised houses	301 service sites
Faire Donne Estate (Medium income development)		56 service sites

Kind regards,



---

**Geraldine Mettler**  
**Municipal Manager**

14.2	<b>QUESTION BY COUNCILLOR F ADAMS: WASTE WATER TREATMENT PLANT IN DEVON VALLEY</b>
------	--

A Notice of a Question, dated 2020-10-27, was received from Councillor F Adams regarding Waste Water Treatment Plant in Devon Valley.

The said Question is attached as **APPENDIX 1** and the appropriate response as **APPENDIX 2**.

**FOR CONSIDERATION**

**FOR FURTHER DETAILS CONTACT:**

<b>NAME</b>	Geraldine Mettler (Ms)
<b>POSITION</b>	<i>Municipal Manager</i>
<b>DIRECTORATE</b>	<i>Office of the Municipal Manager</i>
<b>CONTACT NUMBERS</b>	<i>021 808-8025</i>
<b>E-MAIL ADDRESS</b>	<i>Municipal.Manager@stellenbosch.gov.za</i>
<b>REPORT DATE</b>	<i>November 2020</i>

# **APPENDIX 1**

MUNICIPALITY - MUNISIPALITEIT  
STELLENBOSCH  
27 OCT 2020  
OFFICE OF THE SPEAKER



CONTACT: [oackcity2010@yahoo.com](mailto:oackcity2010@yahoo.com)  
P.O BOX 12445  
DIE BOORD  
7613

Democratic New Civic Association

“Without Prejudice”

28 August 2020

For attention: The Speaker

Stellenbosch Municipality

MUNICIPALITY - MUNISIPALITEIT  
STELLENBOSCH  
27 OCT 2020  
OFFICE OF THE SINGLE WHIP

**Re: Question.**

I hereby submit the following question to serve at the ~~September~~ <sup>November</sup> 2020 Council meeting.

**Motivation/background**

1. I refer to the waste water treatment plant in Devon valley in progress for nearly ten years. Thus far Council didn't receive a comprehension progress report on the expenditure of said project.

**Question:**

- a. What is the total cost for construction to the Municipality, since the beginning until now and all expenses paid for consultancy fees?

I request the portfolio chairperson to answer in writing.

Clr. Franklin Adams

**Aluta Continua**

MUNICIPALITY - MUNISIPALITEIT  
STELLENBOSCH  
28 AUG 2020  
OFFICE OF THE SINGLE WHIP

# **APPENDIX 2**



# MEMORANDUM

*Office of the Municipal Manager  
Kantoor van die Munisipale Bestuurder*

---

**TO : SPEAKER**  
**FROM : MUNICIPAL MANAGER**  
**DATE : 11 NOVEMBER 2020**  
**RE : REPLY TO QUESTIONS IN TERMS OF SECTION 35 OF THE  
STANDING RULES AND ORDER FOR THE MEETINGS OF COUNCIL**

---

Dear Speaker

With reference to the question received from the DNCA, Councillor F Adams submitted in terms of Section 35 of the Standing Rules and Order for the meetings of council, received by my office.

## QUESTION

"I refer to the waste water treatment plant in Devon Valley in progress for nearly ten years. Thus far Council didn't receive a comprehensive progress report on the expenditure of said project.

- a) What is the total cost for construction to the Municipality, since the beginning until now and all expenses paid for consultancy?"

## RESPONSE

CONTRACT	CONTRACT STATUS	CONTRACT PERIOD	CONTRACT APPOINTMENT VALUE	CERTIFIED AMOUNT AT COMPLETION
Civil	Completed	March 2015 – February 2020	R 189,066,386.65 Phase 1 & 2	R 188,922,510.38 Phase 1 & 2
Mechanical and Electrical	Phase 1 completed. Contract in Defects Liability Period for Phase 2	March 2015 – April 2021	R 205,287,711.05 Phase 1 & 2	R 198,166,515.44 Phase 1 & 2
Engineering	Stage 6 - Close out	January 2014 – April 2021		R 37,967,538.77

Kind regards,

---

**CLLR Q SMIT**  
**PORTFOLIO CHAIRPERSON: INFRASTRUCTURE SERVICES**



14.3	<b>QUESTION BY COUNCILLOR LK HORSBAND (MS): 5-YEAR CONTRACT OF THE MUNICIPAL MANAGER (MS G METTLER)</b>
------	---

A Notice of a Question, dated 2020-11-10, was received from Councillor LK Horsband (Ms) regarding 5-year contract of the Municipal Manager (Ms G Mettler).

The said Question is attached as **APPENDIX 1** and the appropriate response as **APPENDIX 2**.

**FOR CONSIDERATION**

**FOR FURTHER DETAILS CONTACT:**

<b>NAME</b>	Geraldine Mettler (Ms)
<b>POSITION</b>	<i>Municipal Manager</i>
<b>DIRECTORATE</b>	<i>Office of the Municipal Manager</i>
<b>CONTACT NUMBERS</b>	<i>021 808-8025</i>
<b>E-MAIL ADDRESS</b>	<i>Municipal.Manager@stellenbosch.gov.za</i>
<b>REPORT DATE</b>	<i>November 2020</i>

# APPENDIX 1



10 November 2020  
 The Speaker  
 Stellenbosch Municipal Council  
 Plein Street  
 STELLENBOSCH  
 7600  
 Attention : Clr W Petersen



Dear Speaker

**RE NOTICE OF QUESTION TO SERVE AT THE NEXT COUNCIL MEETING SCHEDULED FOR NOVEMBER 2020**

**QUESTION NO 1**

In which letter from the NATIONAL MINISTER Des van Rooyen in 2017 did the minister approve the salary of the Municipal manager Ms G Mettler for the full term of 5 year Contract?

**MOTIVATION**

In the 17 February 2020 correspondence from Clr P Crawley ( See attached copy ), Clr Crawley writes that the minister has approved the MM salary for the term of her contract. In this regard nowhere in the letters of the National minister at the time , Des van Rooyen, mentioned anywhere that the salary exemption is linked to her full term. In fact her salary was linked to that of the then CFO Mr M Wust. The minister wrote that the MM cannot pay less than Mr M Wust which was her subordinate. As Mr M Wust contract came to an end some years ago it is only just that the MM salary got adjusted to be in line with the regulation as the reason given by the minister for granting the exemption to her salary does not exist anymore ( It must also be noted that the motivation given by the mayor contain false information as the MM never gave up a permanent position at COCT, in fact she got retrenched )

**QUESTION NO 2**

Where is the letter from the then National Minister Des van Rooyen granting the exemption application to appoint Ms G Mettler as the Municipal manager in 2016 without her having obtained the prescribed minimum competency qualifications as prescribed at that time .

**MOTIVATION**

In October 2016 and December 2016 when the Council resolved on the appointment of Ms G Mettler , council were told that at the time that Ms G Mettler applied for the MM position at the municipality , she did not have the minimum competency qualifications and that council must apply for an exemption from the national minister. This exemption also applied for Council even considering her appointment as she did not meet the advertised qualifications. The National Minister Des van Rooyen also wrote to the Mayor in 2017 requesting proof that Ms G Mettler obtained the Minimum competency qualifications.

Clr L Horsband

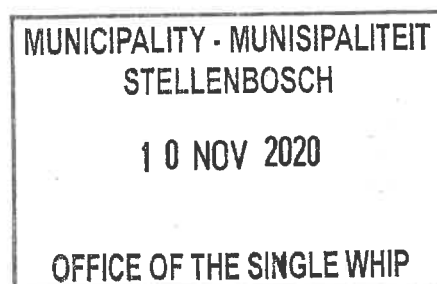

# **APPENDIX 2**



# MEMORANDUM

*Office of the Municipal Manager  
Kantoor van die Munisipale Bestuurder*

---

**TO : SPEAKER**  
**FROM : MUNICIPAL MANAGER**  
**DATE : 10 NOVEMBER 2020**  
**RE : REPLY TO QUESTIONS IN TERMS OF SECTION 35 OF THE  
STANDING RULES AND ORDER FOR THE MEETINGS OF COUNCIL**

---

Dear Speaker

With reference to the question received from the EFF, Councillor L Horsband submitted in terms of Section 35 of the Standing Rules and Order for the meetings of council, received by my office.

## **QUESTION 1**

“In which letter from the National Minister Des van Rooyen in 2017 did the minister approve the salary of the Municipal Manager Ms G Mettler for the full term of 5-year contract?”

## **RESPONSE**

Feedback which relates to your question was clearly addressed at the 11<sup>th</sup> Council Meeting as contained in Item 14.4: 2020-08-30 [In-Committee] of which you were part. Letter in question was annexed hereto.

Kind regards,

---

**Geraldine Mettler  
Municipal Manager**

14.4	<b>QUESTION BY COUNCILLOR LK HORSBAND (MS): MINIMUM COMPETENCY QUALIFICATIONS: MS G METTLER</b>
------	---

A Notice of a Question, dated 2020-11-10, was received from Councillor LK Horsband (Ms) regarding minimum competency qualifications: Ms G Mettler.

The said Question is attached as **APPENDIX 1** and the appropriate response as **APPENDIX 2**.

**FOR CONSIDERATION**

**FOR FURTHER DETAILS CONTACT:**

<b>NAME</b>	Geraldine Mettler (Ms)
<b>POSITION</b>	<i>Municipal Manager</i>
<b>DIRECTORATE</b>	<i>Office of the Municipal Manager</i>
<b>CONTACT NUMBERS</b>	<i>021 808-8025</i>
<b>E-MAIL ADDRESS</b>	<i>Municipal.Manager@stellenbosch.gov.za</i>
<b>REPORT DATE</b>	<i>November 2020</i>

# APPENDIX 1



10 November 2020  
 The Speaker  
 Stellenbosch Municipal Council  
 Plein Street  
 STELLENBOSCH  
 7600  
 Attention : Clr W Petersen

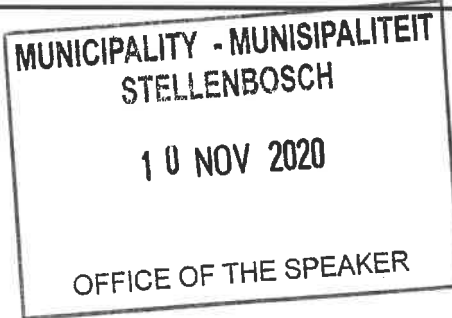

Dear Speaker

**RE NOTICE OF QUESTION TO SERVE AT THE NEXT COUNCIL MEETING SCHEDULED FOR NOVEMBER 2020**

**QUESTION NO 1**

In which letter from the NATIONAL MINISTER Des van Rooyen in 2017 did the minister approve the salary of the Municipal manager Ms G Mettler for the full term of 5 year Contract?

**MOTIVATION**

In the 17 February 2020 correspondence from Clr P Crawley ( See attached copy ), Clr Crawley writes that the minister has approved the MM salary for the term of her contract. In this regard nowhere in the letters of the National minister at the time , Des van Rooyen, mentioned anywhere that the salary exemption is linked to her full term. In fact her salary was linked to that of the then CFO Mr M Wust. The minister wrote that the MM cannot pay less than Mr M Wust which was her subordinate. As Mr M Wust contract came to an end some years ago it is only just that the MM salary got adjusted to be in line with the regulation as the reason given by the minister for granting the exemption to her salary does not exist anymore ( It must also be noted that the motivation given by the mayor contain false information as the MM never gave up a permanent position at COCT, in fact she got retrenched )

**QUESTION NO 2**

Where is the letter from the then National Minister Des van Rooyen granting the exemption application to appoint Ms G Mettler as the Municipal manager in 2016 without her having obtained the prescribed minimum competency qualifications as prescribed at that time .

**MOTIVATION**

In October 2016 and December 2016 when the Council resolved on the appointment of Ms G Mettler , council were told that at the time that Ms G Mettler applied for the MM position at the municipality , she did not have the minimum competency qualifications and that council must apply for an exemption from the national minister. This exemption also applied for Council even considering her appointment as she did not meet the advertised qualifications. The National Minister Des van Rooyen also wrote to the Mayor in 2017 requesting proof that Ms G Mettler obtained the Minimum competency qualifications.

Clr L Horsband

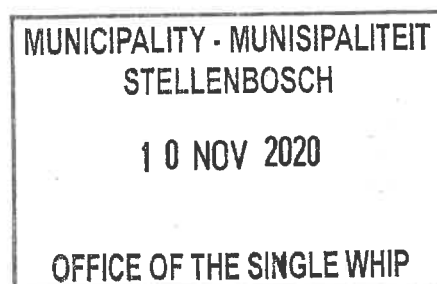



# **APPENDIX 2**

**MEMORANDUM**

*Office of the Municipal Manager  
Kantoor van die Munisipale Bestuurder*

---

**TO : SPEAKER**  
**FROM : MUNICIPAL MANAGER**  
**DATE : 10 NOVEMBER 2020**  
**RE : REPLY TO QUESTIONS IN TERMS OF SECTION 35 OF THE  
STANDING RULES AND ORDER FOR THE MEETINGS OF COUNCIL**

---

Dear Speaker

With reference to the question received from the EFF, Councillor L Horsband submitted in terms of Section 35 of the Standing Rules and Order for the meetings of council, received by my office.

**QUESTION 2**

“Where is the letter from the then National Minister Des van Rooyen granting the exemption application to appoint Ms G Mettler as the Municipal manager in 2016 without her having obtained the prescribed minimum competency qualifications as prescribed at that time?”

**RESPONSE**

The Municipal Manager has already obtained the prescribed minimum competency qualifications by the time she commenced with her employment contract at the municipality, therefore no exemption application was submitted.

Kind regards,

---

**Geraldine Mettler**  
**Municipal Manager**

14.5	<b>QUESTION BY COUNCILLOR DA HENDRICKSE: PRIVATE SECURITY COMPANIES</b>
------	---

A Notice of a Question, dated 2020-11-10, was received from Councillor DA Hendrickse regarding private security companies.

The said Question is attached as **APPENDIX 1** and the appropriate response as **APPENDIX 2**.

**FOR CONSIDERATION**

**FOR FURTHER DETAILS CONTACT:**

<b>NAME</b>	Geraldine Mettler (Ms)
<b>POSITION</b>	<i>Municipal Manager</i>
<b>DIRECTORATE</b>	<i>Office of the Municipal Manager</i>
<b>CONTACT NUMBERS</b>	<i>021 808-8025</i>
<b>E-MAIL ADDRESS</b>	<i>Municipal.Manager@stellenbosch.gov.za</i>
<b>REPORT DATE</b>	<i>October 2020</i>

# APPENDIX 1



10 November 2020 *de*  
~~15 September 2020~~

The Speaker  
 Stellenbosch Municipal Council  
 Plein Street  
 STELLENBOSCH  
 7600  
 Attention : Clr N Jindela

Dear Speaker

*de*  
 NOVEMBER

**RE NOTICE OF QUESTION TO SERVE AT THE NEXT COUNCIL MEETING SCHEDULED FOR SEPTEMBER 2020**

**QUESTION NO 1**

Which is the list of security companies employed by the Stellenbosch municipality to assist the municipality and dealing with the public protest actions and in terms of which legislation and by-laws are private security companies employed by the Stellenbosch municipality to provide these security services to the Stellenbosch municipality in dealing with the public protest actions and do public monitoring and searching of the public.

**MOTIVATION**

We have noticed in the past months the presence of private security companies working with municipal law enforcement officials and SAPS ,when there have been public protest actions in Stellenbosch and even at the magistrate court. These private security companies also have camera systems erected in the municipality and even search people. SAPS has also confirmed that they have received complaints from the public about security companies searching people as they please .The security companies even say that they are appointed by and authorised by the municipality and given policing powers.

Clr DA Hendrickse

*DA Hendrickse*

MUNICIPALITY - MUNISIPALITEIT  
 STELLENBOSCH  
 15 SEP 2020 *[Signature]*  
 OFFICE OF THE SINGLE WHIP

MUNICIPALITY - MUNISIPALITEIT  
 STELLENBOSCH  
 15 SEP 2020  
*[Signature]*  
 OFFICE OF THE SPEAKER

# APPENDIX 2

**MEMORANDUM**

*Office of the Municipal Manager  
Kantoor van die Munisipale Bestuurder*

---

**TO : SPEAKER**  
**FROM : MUNICIPAL MANAGER**  
**DATE : 10 NOVEMBER 2020**  
**RE : REPLY TO QUESTIONS IN TERMS OF SECTION 35 OF THE  
STANDING RULES AND ORDER FOR THE MEETINGS OF COUNCIL**

---

Dear Speaker

With reference to the question received from the DA Hendrickse submitted in terms of Section 35 of the Standing Rules and Order for the meetings of council, received by my office.

**QUESTION 1**

“Which is the list of security companies employed by the Stellenbosch Municipality to assist the municipality and dealing with the public protest actions and in terms of which legislation and by-laws are private security companies employed by the Stellenbosch Municipality to provide these security services to the Stellenbosch Municipality in dealing with the public protest actions and no public monitoring and searching of the public.”

**RESPONSE**

The Municipality has not employed any security companies to assist in dealing with public protest actions. In terms of the Stellenbosch Safety Initiative (SSI) and the approved Safety Plan of Stellenbosch Municipality there is a Memorandum of Cooperation between the Security Companies and the Municipality to assist in monitoring of crime hotspots and to report any criminal behavior. These security companies also assist the Traffic and Law Enforcement disciplines with Vehicle check points (Mini roadblocks) where they only render a security presence “show of force”. No authority was granted by the Municipality to security companies to search any person. Furthermore, they do not have any policing powers. A formal charge must be laid with evidence at the South African Police against any security company that deviates from the ambit of the law.

Kind regards,

---

**Geraldine Mettler  
Municipal Manager**

---

15.	CONSIDERATION OF URGENT MOTIONS
-----	---------------------------------

16.	URGENT MATTERS SUBMITTED BY THE MUNICIPAL MANAGER
-----	---

17.	REPORTS SUBMITTED BY THE SPEAKER
-----	----------------------------------

NONE

18.	REPORTS SUBMITTED BY THE EXECUTIVE MAYOR
-----	--

NONE

19.	MATTERS TO BE CONSIDERED IN-COMMITTEE
-----	---------------------------------------

(SEE IN-COMMITTEE DOCUMENTATION)

---

***THE AGENDA HAS BEEN DISCUSSED WITH THE SPEAKER, CLLR WC PETERSEN (MS), AND SHE AGREES WITH THE CONTENT.***

---